



鼎安达玻璃
DingAnDa Glass

天津市鼎安达玻璃有限公司
Tianjin DingAnDa Glass Co.,LTD

地址:天津市北辰区韩家墅钢材市场C区后道41号
网址:www.dadglass.com



鼎安达玻璃
DingAnDa Glass

天津市鼎安达玻璃有限公司
Tianjin DingAnDa Glass Co.,LTD

The 公司简介

天津市鼎安达玻璃有限公司
Tianjin DingAnDa Glass Co.,LTD

辉煌时刻 展望未来

Look to the future for glorious moments

Chapter 1: Glory

Tianjin DingAnDa Glass Co., Ltd., founded in 1997, is located in Tianjin, the logistics center city of North China, after 20 years of development, gradually become a bright star in China glass industry, is the most complete enterprise in the integration of domestic glass resources, and a leading enterprise in the glass industry.

Based in Tianjin, the company takes Shahe, the base of China's glass industry, as a large glass and glass accessories consumables warehouse to radiate the whole country, and opens up overseas sales channels at coastal ports such as Qingdao and Tianjin. After several years of rapid development, the company owns Tianjin Risheng Yuan Glass Technology Co., Ltd., Tianjin Dinganda Logistics Co., Ltd., Qingdao Dinganda Glass Technology Co., Ltd., Shahe Dinganda Glass Branch and Shahe Dinganda Logistics Branch and Shanxi Dinganda Glass Branch, with glass trade, glass machinery, special glass, glass chemical, glass logistics, glass consumables and foreign trade export and other seven major sectors of business, becoming the industry's top enterprises, like a brilliant star in the glass industry, standing tall in China, Go global!

Chapter 2: Strength

Seeking development with innovation and establishing a brand with responsibility have created a value model of Dinganda Glass National Enterprise. In line with the enterprise spirit of "perseverance, excellence, advancing with the times, constantly opening up, and climbing the peak forever", we constantly pursue the expansion of production scale, the rationalization of product structure and the improvement of corporate culture system to promote the improvement of the comprehensive strength of enterprises.

Mr. Zhang Jian, chairman of the company, is an excellent entrepreneur in the glass industry, who has been engaged in the glass industry for more than 30 years and is an expert in the integration of glass resources in China. He led all employees to overcome difficulties and forge ahead, and gradually expanded to glass logistics, glass machinery, glass chemical industry, special glass, glass consumables accessories and foreign trade export and other businesses, and gradually formed a new pattern of common development of seven major sectors of business.

Brand driven management, quality achieves glory. Dinganda regularly participates in China International Glass Exhibition every year, and participates in exhibitions in Singapore, India, Germany, Turkey and other overseas countries from time to time, learning advanced management experience and product knowledge from it, and constantly improving the company's popularity at home and abroad. At the same time, it has formed long-term strategic partnerships with many enterprises at home and abroad, covering 32 provinces, municipalities and autonomous regions in China, and expanded hundreds of foreign customers, winning the trust and appreciation of customers at home and abroad.

Chapter 3: Expectation

Entering a new period of development, DingAnda's grand blueprint has just unfolded, the company will revitalize to build a first-class enterprise, develop domestic and foreign markets as the goal, adhere to the "quality is the life of the enterprise, reputation is the development of the enterprise" as the business philosophy, abide by the "produce customer satisfaction products, provide customer satisfaction service" for the purpose of the enterprise, in the fierce competition market plug in the wings, set sail, across the world!



产品专利十余种



上海YATO合作伙伴



日本SMC合作伙伴

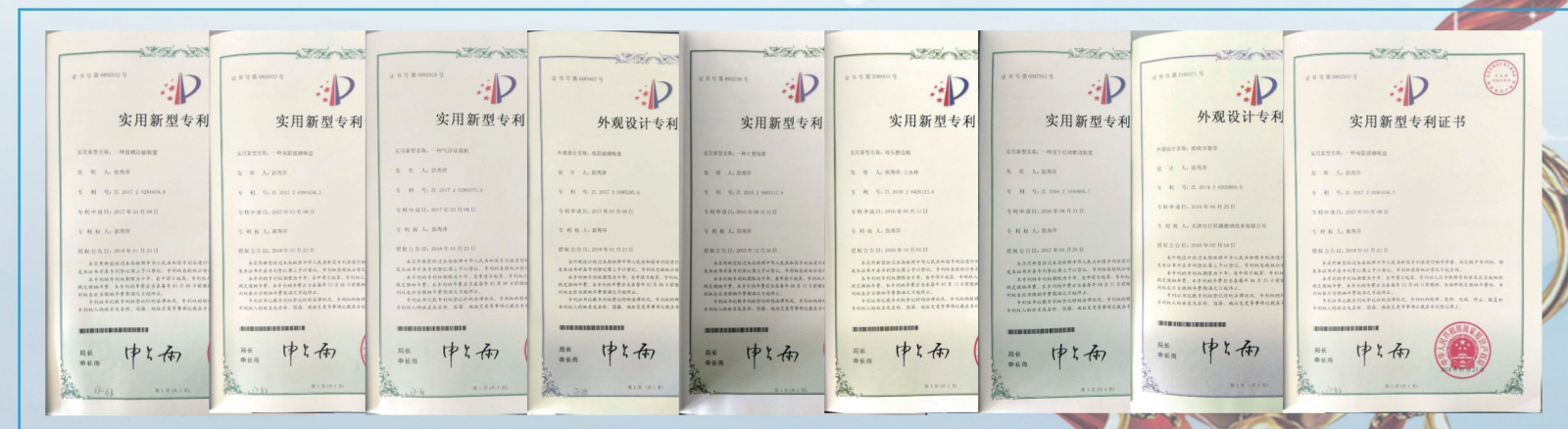

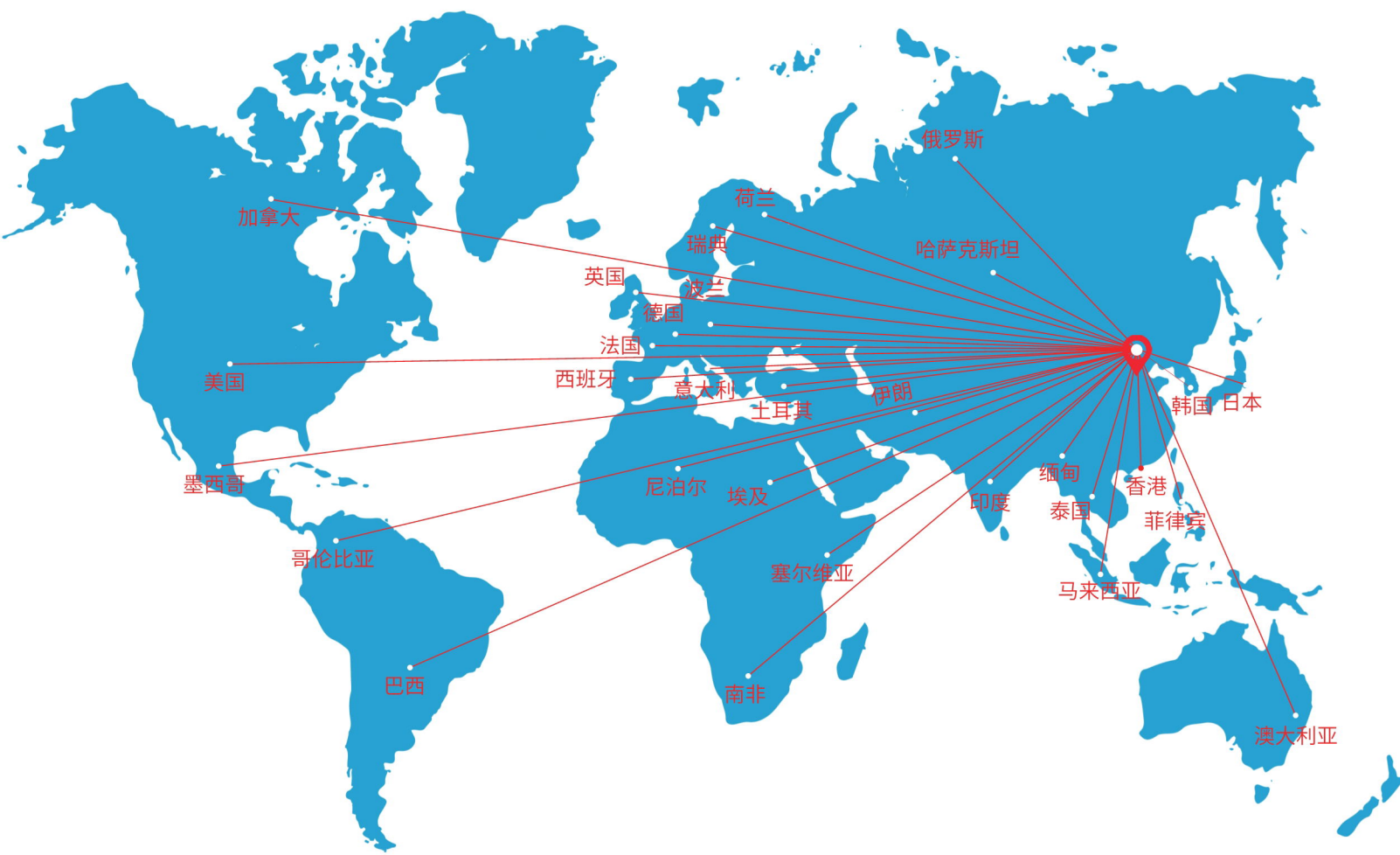

Products sell well in both domestic and overseas markets

Tianjin Dinganda Glass Co Ltd

Tianjin Rishengyuan Glass Technology Co., Ltd
 Qingdao Dinganda Glass Technology Co.,Ltd
 Hebei Dinganda Glass Technology Co.,Ltd
 Tianjin Dinganda Glass Co.,Ltd Shahe Branch
 Tianjin Tongdali Glass Co.,Ltd

目录 Directory

PAGE	污水处理设备 Sewage Treatment Equipment	05-06
	加强型污水处理设备 Enhanced sewage treatment equipment-----	05
	普通型污水处理设备 Common sewage treatment equipment-----	06
PAGE	纯净水设备 Water Purification Equipment	07
	大型纯净水处理设备 Large-scale Water Purification Equipment-----	07
	食品级PVC水处理设备 Food grade PVC water treatment equipment-----	07
PAGE	玻璃专用循环水处理设备 Glass-Dedicated Water Circulating Filter	08
	叠片式循环过滤器 Strap Type Circulating Filter-----	08
	双通道式循环过滤器 Dual-Channel Circulating Filter-----	08
PAGE	滤材与配件 Filter Materials And Accessories	09
PAGE	经典案例 Classic Case	10
PAGE	夹胶炉设备 EVA Glass Laminating Machine	11-12
	强对流循环风夹胶炉 Strong Convective Circulation Wind Laminated Furnace-----	11
	360°单区炉/360°single zone single temperature furnace-----	12
	360°双区双温炉/360°dual zone dual temperature furnace-----	12
PAGE	蒙砂玻璃生产线 Acid Etched Producing Machine	13-14
PAGE	抛光生产线 Polishing Production Line	13-14
PAGE	纳米硅防火玻璃生产线 Nano Fireproof Glass Producing Line	15-16
PAGE	烧检炉 Fire Proof Glass Testing Furnace	17-18
PAGE	吸盘系列 Glass Sucker Series	19-30
	气动吸盘 Pneumatic Vacuum Glass Lifter Sucker-----	19-22
	电动吸盘 Electrical Glass Lifter Sucker-----	23-25
	电动旋臂起重机 Electric Slewing Crane-----	26
	玻璃鱼缸专用吸盘 Vacuum Glass Lifter Dedicated for Fish Tanks-----	26
	夹层玻璃生产线合片专用吸盘 Laminated Glass Dedicated Sucker-----	27
	龙门架式真空吸盘 Portal-Frame Shape Vacuum Glass Sucker-----	28
	电动吸盘车 Electric Glass Robot-----	29
PAGE	磨边机系列 Edge Grinding Machine Series	31-32
	新X-02双磨头磨边机 New X-20 Double Head Edge Grinding Machine-----	31
	RSY-08A多功能磨边机 RSY-08A Multifunctional Edge Grinder-----	32
	水式砂带机 Water Type Belt Machine-----	32

PAGE	叉车吊臂系列 Forklift Truck Crane Arm Series	33-34
	经典式叉车吊臂 Classic Forklift Truck Crane Arm-----	33
	底座式叉车吊臂 Base Forklift Truck Crane-----	33
	吊杠置顶式叉车吊臂 Hanging Bar Set-top Forklift Truck Crane Arm-----	34
	新式叉车吊臂 New-style Forklift Truck Crane Arm-----	34
PAGE	U型吊臂 Container U-Shape Suspension Arm	35
PAGE	叉车串杆 Glass Container Unloading Tool(with crane)	36
PAGE	玻璃上片台C款 Glass-loading Table C Type	37
PAGE	玻璃专用吊带系列 Glass Sling Series	38
PAGE	吊杠系列 Hanging Bar Series	39
PAGE	玻璃吊夹系列 Glass Supporting Clamp Series	40
	意大利LC吊夹 LC Glass Clamp-----	40
	全自动鳄鱼吊夹 Full-automatic Glass supporting clamp-----	40
PAGE	除膜机系列 Flim-Removing Machine Series	41-42
	气浮式除膜机 Air Floating Film-Removing Machine-----	41
	双磨头除膜机 Double Head Film-Removing Machine-----	41
	万向轮式除膜机 Universal Wheel Film Removing Machine-----	42
	双手持Low-E除膜机 Offline Low-E Glass Film-Removing Machine-----	42
	单手持Low-E除膜机 One-hand Operation Low-E Coating Removing Machine-----	42
PAGE	玻璃放置架系列 Class Storck Rack Series	43-47
	L架 L Shape Shelf-----	43
	L架速压杆 L Rack Fixed Bar-----	44
	L架倒片杆 L Frame Layered Rewinding Rod-----	44
	玻璃精品架 High Quality Glass Shelf-----	44
	AL型玻璃原片放置架 AL-Type Sheet Glass Stock Shelf-----	45
	A字架 A Shape Shelf-----	45
	移动仓储架 Removable Storage Glass Shelf Specification-----	46
	特殊定制玻璃放置架 Customized Glass Rack-----	47
PAGE	工具箱系列 Mechanical Maintenance Tool Car	48
PAGE	玻璃去霉套装 Glass Musty Removing Set	49
PAGE	玻璃划痕修复工具 The Fixing Tool For The Glass Scratches	50
PAGE	风冷清胶工具 Cold and Windy Glue Tool	51



天津市日昇源玻璃技术有限公司 Tianjin Rishengyuan Glass Technology Co.,Ltd

天津市日昇源玻璃技术有限公司成立于2013年，地处美丽的海滨城市天津，是一家专业从事玻璃机械和特种玻璃产品研发、生产和销售的高新技术企业，公司资金雄厚，生产设备先进，实力过硬，并拥有一支专业过硬经验丰富的研发和生产队伍。公司分为玻璃机械部和特种玻璃工程部，经过两三年的迅速发展，公司已成为国内玻璃机械和特种行业领军企业，产品远销海内外五千多家客户，得到广大客户的赞誉与肯定！

玻璃机械部产品以中小型玻璃机械为主，种类齐全，选材精细，品质过硬。产品有多功能磨边机、双磨头磨边机、夹胶炉、EVA胶片、优质玻璃吊带、加固型吊梁、集装箱U型吊臂、进口玻璃吊夹、全自动玻璃吊夹、手提离线Low-E玻璃除膜机、除膜轮、新式砂带机、叉车吊臂（单臂、双臂）、L型铁架、玻璃放置架、叉车串杆（集装箱大炮）、真空吸盘吊具、涂胶旋转台、转换台、玻璃气浮台和玻璃上片台等相关产品远销国内外，得到广大客户的赞誉和肯定。

“专业决定品质、实力铸就品牌、诚信创造永远”，日昇源与您携手共创辉煌！

Tianjin RiShengYuan Glass Technology Co., Ltd established specialized in research, development and selling of Glass Machinery and Special Glass products. Equipped with strong technical team, advanced production devices and impeccable management system, the company is dedicated to taking the lead of Glass Machinery and Special Glass industry. The company including Glass Machinery department and Special Glass department, with 3 years fast development, our company has been one of the leaders professional Glass Machinery and Special Glass manufacturers in China.

Our main glass machinery products are focus on medium and small size, Full range, Fine material and Excellent Quality. Including Multi-Functional Edge Grinding Machine, Double Edge Grinding Machine, High Quality Glass Lifting Sling, Reinforced Lifting Hanging Bar, Container U-shape Offloading Device, Semi-Automatic and Automatic Crocodile Clamp, Portable off line Low-E Glass Film-Removing machine, Low-E Glass Film-Removing wheel, New-Design Belt Grinders, Forklift Crane Arm (Single and Double arm), Glass Shelf, and Forklift Truck Skewer, Vacuum Glass Sucker/Lifter, Rotary Table for Gluing, Conversion Table and Glass Loading Machine. Products are sold at domestic and abroad and highly praise by our customers.

RiShengYuan is willing to work with you hand in hand to create a brilliant future!

加强型污水处理设备 Enhanced sewage treatment equipment



JQ-1-Nt

高浊度玻璃粉分离系统——为玻璃行业精心打造

采用公司新研发的技术，对玻璃深加工过程中废水的高浓度微粉和超微粉等杂质进行深度净化，该系统依靠化学反应、物理吸附、悬浮泥层精细过滤和流体力学分离的原理相结合，通过快速、高效、经济的物理化学法直接处理高浊度和高浓度污水，处理后的水可达到三级精细净化水的水准。根据磨边用水和磨边后清洗用水的特点，处理后的水质SS小于5mg/L；不但可以满足清洗和磨边机的用水要求，也可通过碳滤和砂滤等处理后，达到进入反渗透设备纯水的要求，生产用水可实现95%以上的循环利用。

设备可实行全程自动化控制，操作简单，运行成本低，设备占地面积小，出水水质高，损耗低，大幅度降低企业能源损耗，节约成本。

High-Turbidity Glass Power Filtration System — dedicated to glass industry

The sewage treatment equipment adopts Dinganda's newly developed technology to filter high-concentration micropowder and ultrafine powder contained in the wastewater produced by deep processing of glass. With a physical-chemical combination of chemical reaction, physical absorption, fine filtration of suspended sludge and hydrodynamic separation, the system can directly and economically process and purify high-turbidity and high-concentration wastewater with great efficiency and effectiveness, and the purified water can reach the standard of tertiary treatment processes. According to the requirement of water used for glass edging and cleaning, the water quality SS of the purified water is less than 5mg/L, which can meet the requirement of glass edging and cleaning; through activated carbon filtration and sand filtration, the processed water can meet the standard of pure water for reverse osmosis equipment. In this case, production water can achieve a recycling rate of more than 95%. With full-process automation control, the equipment has advantages of simple operation, low operating cost, small land occupation, high water quality and low wastage, which will greatly cut energy consumption and costs for the company.

性能参数及特点:

1. 清水生产量: 3-100m³/h/台
2. 玻璃粉回收量: 30-500kg/h/台 (干粉计)
3. 颗粒物回收率: >90%
4. 出水水质SS: <5mg/L, 肉眼观测无明显悬浮物; 出水水质可达到磨边机循环用水水质要求。
5. 出水压力: >0.1MPa
6. 控制方式: PLC自动及部分手动控制

Specifications and characteristics:

1. Output of purified water: 3-100m³/h/machine
2. Recovery of glass powder: 30-500kg/h/machine (dry powder parameter)
3. Recycling rate of particulate matter: >90%
4. Output water quality SS: <5mg/L, no obvious suspended solids with naked eyes; can be used as recycling water for edge grinding machine.
5. Hydraulic pressure: >0.1MPa
6. Operation: PLC automatic and partial manual control

普通型污水处理设备 Common sewage treatment equipment

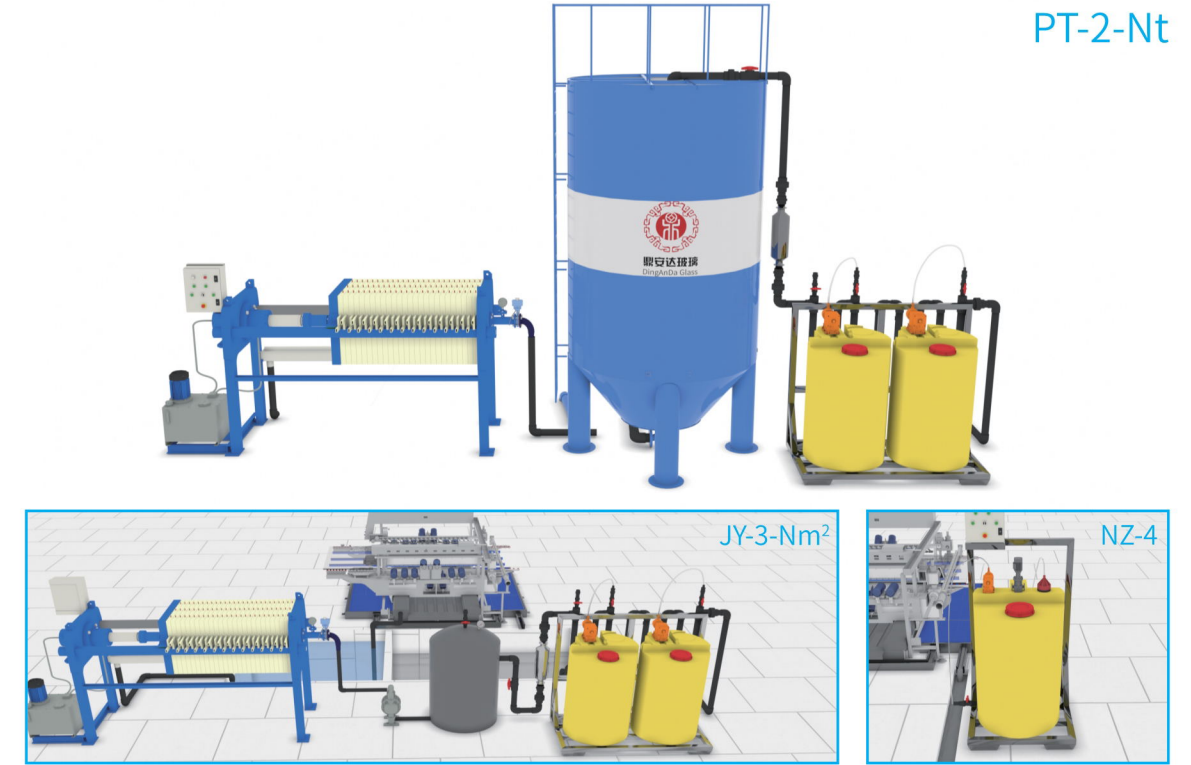

PT-2-Nt

简易型污水处理设备/Simple sewage treatment equipment

凝渣机/Slag coagulator

玻璃深加工行业为例

型号 Type	处理量m ³ /h Handling Capacity (m ³ /h)	设备尺寸 Equipment Size		运行功率 Operating Power	系统占地 面积m ² Floor Space(m ²)
		轮廓直径 Profile Diameter	高度(mm) Height(mm)		
JQ-1-03	3	φ800	2800	1.1kW	15m ²
JQ-1-05	5	φ1300	3200	1.5kW	20m ²
JQ-1-10	10	φ1550	4200	2.5kW	25m ²
JQ-1-15	15	φ1800	4300	2.5kW	30m ²
JQ-1-20	20	φ2150	4600	2.5kW	30m ²
JQ-1-25	25	φ2300	4900	4kW	35m ²
JQ-1-30	30	φ2450	5000	4kW	40m ²
JQ-1-45	45	φ3000	5500	4kW	50m ²
JQ-1-60	60	φ3600	5700	7kW	75m ²
JQ-1-75	75	φ3650	6300	8kW	75m ²
JQ-1-100	100	φ4100	6300	12kW	80m ²
JQ-1-125	125	φ4200	6600	12kW	90m ²
PT-2-40	40/主罐1个	φ2800	4800	7.5kW	25m ²
PT-2-80	80/主罐2个	φ2800	4800	15kW	40m ²
PT-2-120	120/主罐3个	φ2800	4800	20kW	60m ²

注: 数据仅供参考。

纯净水设备
Water Purification Equipment



大型纯净水处理设备 Large-scale Water Purification Equipment

大型纯净水处理设备
Large-scale Water Purification Equipment

反渗透水处理设备的反渗透膜是为了实现水溶液的反渗透现象，采用特殊工艺人工合成的一种半透膜。反渗透膜的孔径为0.0001微米(μm)，只有水分子才能通过，而其溶质不能通过分渗透膜。在纯水机的净水系统中，反渗透膜专指成形的反渗透滤芯。反渗透膜滤芯是纯水机净水系统的核心部件，只有使用了分渗透膜滤芯，才能称为纯水机。RO膜可以去除水中的重金属、化学物质、颗粒物、细菌病毒放射性物质等对人体有害物质。
设计产水量:0.5-500T/h(小时/吨)

The reverse osmosis (RO) membrane of RO water treatment equipment is a semi-permeable membrane artificially synthesized with special process in order to realize the RO of the aqueous solution. With pore size of the RO membrane reached 0.0001 micron (μm), only water molecules can permeate while solute cannot. In the water purification system of water purification equipment, the RO membrane specifically refers to the formed RO filter element, which is the core component of the system. Only when the RO filter element is used can it be called a water purification equipment. RO membrane can filter heavy metals, chemical substances, particulate matter, bacterial virus, radioactive substances and other harmful substances to the human body in the water.
Designed output: 0.5-500T/h (hour/ton)

食品级PVC水处理设备
Food grade PVC water treatment equipment

适用于:职工日常饮用;Low-E玻璃洗片及各类清洗机使用。
Apply to: drinking water, usage for Low-e and other cleaning machine
1. 不锈钢机架、PVC管件、玻璃钢罐(自动、半自动)
Stainless steel frame, PVC pipe fitting, glass storage tank (automatic, semi-automatic)
2. 产水量0.5-20T/小时
Output: 0.5-20T/hour
3. 单级反渗透, 出水水质、电导率: ≤30us/m
Single stage RO, output water quality, conductivity: ≤30us/m
4. 水质达到国家《CJ94-2006》直饮水标准
Water quality reaching National Standards for Drinking Water Quality (GB CJ94-2006).



不锈钢净水器



食品级PVC水处理设备

玻璃专用循环水处理设备
Glass-Dedicated Water Circulating Filter



叠片式循环过滤机 Strap Type Circulating Filter

叠片式循环过滤机
Strap Type Circulating Filter

整机小巧, 安装方便, 叠片、布袋双级过滤, 耗材清洗方便, 适用于中空玻璃生产线, 立式清洗机使用。对清洗后的水进行净化再利用, 节水率>85%。中空玻璃生产线洗片专用循环过滤机

The equipment enjoys advantages of small size, easy installation and washing, and strap and deep bed filter. The filter can be applied to double-glazed production line and stand glass washing machine. Through purification and recycling, the water saving percentage of the equipment can exceed 85%. Double-glazed production line dedicated circulating filter equipment.

1. 二级循环过滤
Two-Level Circulating Filtration
一级过滤精度: 300μm (叠片式过滤, 无需更换滤片, 更节能, 更环保)
First level filtration rating: 300μm (strap type filtration, no need to exchange filter leaf, energy-saving and environmental-friendly)
二级过滤精度: 10-50μm (布袋式过滤, 布袋可反复使用)
Second level filtration rating: 10-50μm (deep bed filtration, repeated usage)
2. 出水量: 12T/H
Output: 12T/H

双通道式循环过滤机
Dual-Channel Circulating Filter

四缸设计, 双管路切换, 滤材堵塞自动报警, 切换方便, 大大提高效率, 减少人工操作。适用于卧式清洗机。水循环再利用, 节水率>85%, 滤材清洗方便, 使用寿命更长。

The equipment enjoys advantages of four tanks and dual-channel switchable design, automatic alarm in case of filter material jamming, easy switching, high efficiency and automation. The filter can be applied to horizontal washing machine. Through water recycling, the water saving percentage of the equipment can exceed 85%. Filter material enjoys advantages of easy washing and long service life.

1. 二级循环过滤
Two-Level Circulating Filtration
一级过滤精度: 50μm (布袋式过滤, 布袋可反复使用)
First level filtration rating: 50μm (deep bed filtration, repeated usage)
二级过滤精度: 10μm (布袋式过滤, 布袋可反复使用)
Second level filtration rating: 10 (deep bed filtration, repeated usage)
2. 出水量: ≥12T/H
Output: ≥12T/H

滤材与配件
Filter Materials And Accessories



聚合氧化铝



聚合氯化铝铁



聚丙烯酰胺



活性炭



锰砂



石英砂



PP棉过滤芯



RO膜



加药箱



RO-阻垢剂



RO-还原剂



RO-清洗剂

经典案例
Classic Case



河北香河PT-80T



重庆简易型



河南焦作JQ-15T



重庆JQ-40T



安徽阜阳PT-80T

强对流循环风夹胶炉 Strong Convective Circulation Wind Laminated Furnace



基本信息/Basic Information

设备特点:采用循环风加热方式,温度均匀,从而提高产品品质。PLC变频控制系统,温控精准,预设多段温控;根据不同工艺可任意选择温度段数,分段控制,防止溢胶。产量大,耗能低,占地面积小,是加工客户的理想选择。
Equipment features:Adopt the circulating air heating mode,the temperature is balanced,so as to improve the product quality.PLC frequency conversion control system,accurate temperature control,preset multi-stage temperature control,according to different processes can be arbitrary selection of temperature segment,control segment,prevent glue overflow.Large output,low energy consumption,small footprint,is an ideal choice for processing customers.

设备可生产:普通浮法夹胶玻璃、钢化夹胶玻璃、弧形夹胶玻璃、彩色夹胶玻璃、LED玻璃、调光玻璃、防弹玻璃、多层夹胶玻璃、夹丝玻璃、移门强化写真玻璃、晶钢门玻璃、家电面板玻璃、玻璃护角、影楼水晶写真玻璃、背景墙及影视墙玻璃、茶几面玻璃、隔断屏风、无框画等个性化写真玻璃。
Equipment can be produced:ordinary float laminated glass,tempered laminated glass,curved laminated glass,colored laminated glass,LED glass,dimming glass,bulletproof glass,multi-layer laminated glass,wired glass,sliding door reinforcement Photo glass,crystal steel door glass,home appliance panel glass,glass corner,photo studio crystal photo glass,background wall and video wall glass,coffee table glass,partition screen,frameless painting and other personalized photo glass etc.

技术参数/Technical Parameters

名称 Name	单层单工位 Single layer and single station	双层单工位 Double layer single station	三层单工位 Three-layer single station	四层单工位 Four-layer single station
电源 Power supply	三项交流380v Three the exchange 380v	三项交流380v Three the exchange 380v	三项交流380v Three the exchange 380v	三项交流380v Three the exchange 380v
总功率 Total power	21.3kW	46.7kW	49.7kW	55.7kW
设备外形 Equipment appearance	3000mmX2450mm X1200mm	4200mmX3230mm X1500mm	4200mmX3450mm X1700mm	4200mmX3080mm X2320mm
整机重量 The weight of the whole machine	980KG	2400KG	3050KG	3300KG
真空床套数 Vacuum bed sets	一套	二套	三套	四套
最大加工玻璃尺寸 Maximum glass processing size	1900mmX2500mm	2440mmX3660mm	2440mmX3660mm	2440mmX3660mm

备注:设备异型可根据客户要求制作 Note:the device profile can be produced according to customer requirements

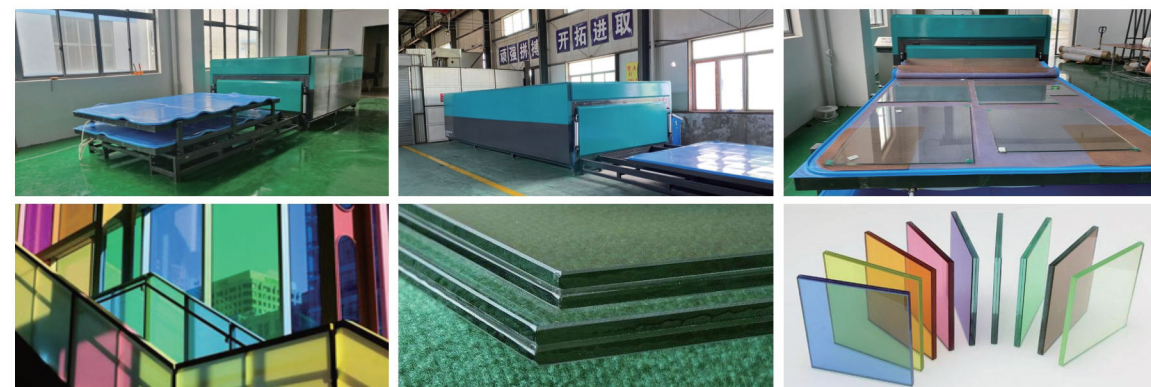

夹胶炉 Laminating Furnace



360°单区炉/360°single zone furnace

基本信息/Basic Information

360°循环风,炉内循环无死角,温度均匀。有换气系统,达到加温时的温度均衡,在加工完成无人看守时,可打开换气系统,进行冷却,增加产品亮度。
360°circulating air keeps the air float within the furnace, with even temperature. There is a ventilation system to achieve the temperature balance during heating. When the processing complete unattended, the ventilation system can be opened to cool down the internal temperature and increase the brightness of the product.



360°双区双温炉/360° dual zone dual temperature furnace

基本信息/Basic Information

双区双温设计,可以同炉加工不同规格、不同参数的玻璃,360°循环风,如双区四层单工位,有液压平台,节约场地。有换气装置,后期如增加产量,可加装双套系统。
The dual-zone dual-temperature design can process glass of different specifications and different parameters in the same furnace with 360°circulating air. For dual-zone four-layer single station furnace, it comes with hydraulic platform can save space. There is a ventilation device. If the production increases in the future, a double system can be installed.

技术参数/Technical Parameters

名称	360°单区单温炉	360°双区双温炉	Name	360°single zone single temperature furnace	360°dual zone dual temperature furnace
型号	2440X3660		Model	2440X3660	
长度	9.5m	9.5m	Length	9.5m	9.5m
宽度	3.2m	3.3m	Width	3.2m	3.3m
高度	1.8m	2.9m	Height	1.8m	2.9m
功率	42kW	60kW	Power	42kW	60kW

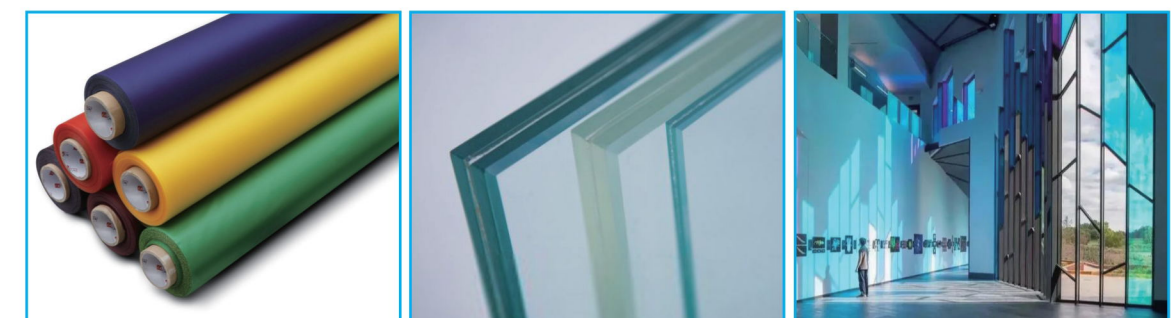

蒙砂玻璃生产线
Acid Etched Producing Machine

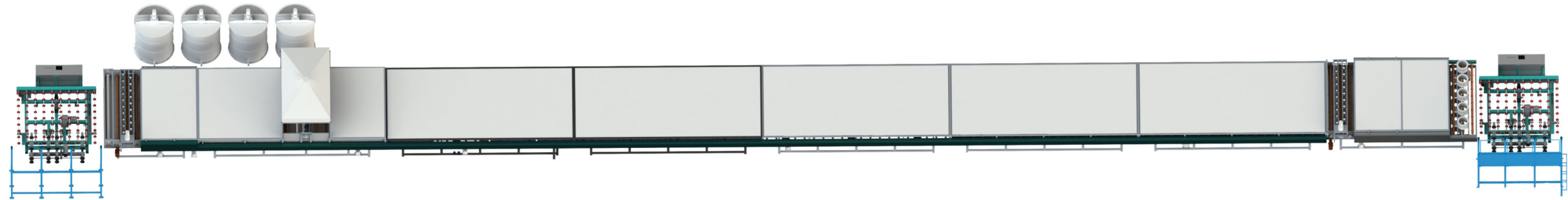

基本信息/Basic Information

1. 卧式平线生产, 品质及产量远高于竖池生产。整版颗粒度可控, 光泽度比较均匀, 不用胶带封边, 且没有亮边, 提高成品的利用率。
2. 全线不用贴膜, 3-4人即可生产, 减少原材料成本。正常生产可以达到30-40秒/片的成品下片。
3. 生产线采用全封闭式, 有利于废气的收集与排放。一次成型, 不用倒玻璃再次清洗, 药液及水可以循环使用, 用水量极少。
4. 采用合理有效的防霉粉滚涂, 减少夹纸的材料。
5. 公司提供技术支持, 可自行调配所需药液, 减少原料购买成本。根据客户需要可做普通玉砂、无手印玉砂、细蒙砂、细油砂、粗油砂。
6. 本生产线采用自动上下片, 产量大幅增加, 减少人工成本, 降低人工操作风险。

技术参数/Technical Parameters

名称	蒙砂玻璃生产线	Name	Acid Etched Producing Machine
整线长度	60m	Total production line length	60m
宽度	3m	Width	3m
总功率	45kW	The total power	45kW
可根据客户实际场地和产量情况进行特殊定制		Can be customized based on customers actual site space and production needs.	
可定制生产2400*3660大版横向进出设备, 提高产量30%		Customized production of 2440*3660 large horizontal in and out equipmen, increase the output by 30%.	

抛光生产线
Polishing Production Line

基本信息/Basic Information

抛光是较传统蒙砂玻璃生产线更高端的处理设备, 可做各种参数规格的电子白板、AG、画框玻璃, 显示玻璃等。

The polishing line is a higher-end processing equipment than the traditional acid etched glass production line. It can be used for electronic whiteboards, AG, frame glass, display glass, etc. of various specifications.

1. 配套有贴膜机和清洗机、检测台可选。
2. 整线采用平线排列加压喷淋方式, 整版技术参数均匀。采用程序化控制, 对于不同参数要求的可进行合理有效的调节控制。

1. It is equipped with a filming machine, a cleaning machine, and a testing table.
2. The whole line adopts flat line arrangement and pressure spraying method, and the technical parameters of the whole page are uniform. Using programmed control, reasonable and effective adjustment and control can be carried out for different parameter requirements.

技术参数/Technical Parameters

名称 Name	抛光生产线 Polishing Production Line
整线长度 Total production line length	30m
宽度 Width	3m
总功率 The total power	45kW
可根据客户实际场地和产量情况进行定制 Can be customized based on customers actual site space and production needs.	

抛光生产线
Polishing Production Line

Polishing Production Line

1. Automatic glass loading and unloading in the whole process, increase production output, reduce labor costs and the risk of manual operation.
2. No need to stick film in the whole production line, reduce raw material cost. 3-4 people can operate the whole line. The normal production can reach 30-40 seconds/piece.
3. Horizontal flat production line has much higher quality and output than vertical tank production. The granularity of the entire page is controllable, the gloss is relatively uniform, no tape is used for edge sealing, and no bright edge, which improves the utilization rate of the finished product.
4. Use high effective anti-mildew powder roll coating to reduce paper jams.
5. The company offers technical support, can dispense the required liquid medicine, reducing the cost of raw material purchase. Ordinary jade sand, jade sand without fingerprints, fine frosted sand, fine oil sand, coarse oil sand can be made according to customer needs.
6. The production line is fully enclosed, is conducive to the collection and discharge of waste gas. One-time molding, no need to pour the glass and clean it again, the liquid medicine and water can be recycled with very little water consumption.

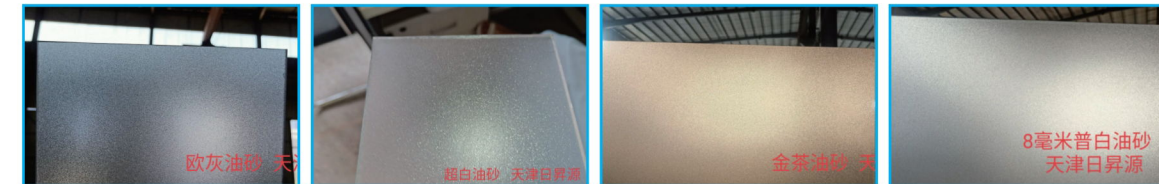

纳米硅防火玻璃生产线 Nano Fireproof Glass Producing Line

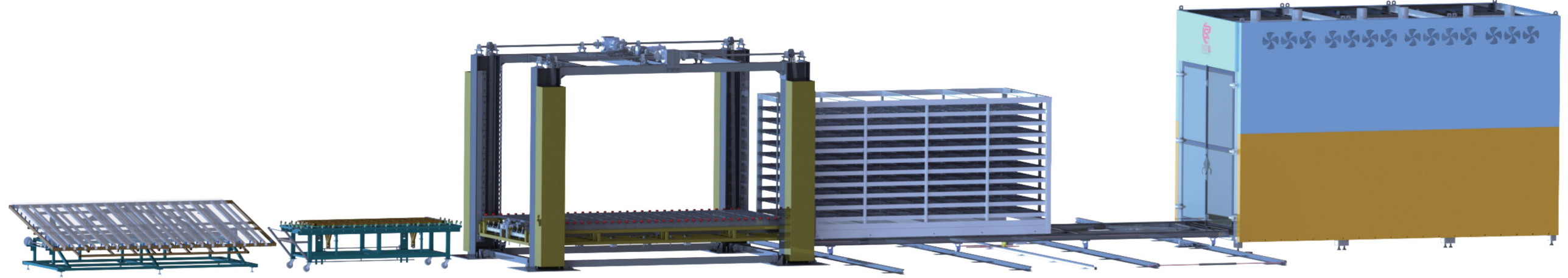

基本信息/Basic Information

我公司生产的纳米硅防火玻璃生产线, 在客户原有的切磨洗钢设备的基础上, 可向客户提供灌注设备, 灌浆平台, 移动过渡台, 全自动升降设备和纳米硅烤炉, 我恒昇源公司目前面向世界生产纳米硅防火玻璃, 有着强大的技术支持做后盾, 可对客户做到设备、技术、纳米硅原料防火材料的全方位服务, 达到买最好的设备, 做最好的玻璃!

纳米硅复合防火玻璃是指由两层或多层玻璃原片灌注一层或多层水溶性无机纳米硅复合而成的, 并能够同时满足耐火完整性、耐火隔热性要求的一种防火玻璃。

当火灾发生时, 向火面玻璃遇高温后很快炸裂, 防火胶夹层开始发泡膨胀, 形成坚硬的不透明防火胶板, 以有效地阻断向火面的火焰向背火面蔓延, 同时也阻断了向火面燃烧产生的热量从向火面向背火面传导。

在火灾中, 纳米硅可始终保持最佳的耐火完整性。其向火面玻璃在遇火后会很快炸裂, 而内在独特的防火胶层将伴随温度的升高相继发泡膨胀, 过程中吸收大量火焰热(使玻璃背火面的表面温度平均不超过140°C), 形成不透明防火胶板, 有效阻隔高温、火焰、烟雾及有毒气体, 提供真正安全保护。

Our company's nano-silicon fire-resistant glass production line can provide filling equipment, grouting platform, mobile transition table, automatic lifting equipment and nano-silicon oven on the basis of the customer's original cutting, grinding and washing steel equipment.

Our company, Hengshengyuan, produce nano-silicon fire-resistant glass, with strong technical support, can provide customer with a full range of equipment, technology, and nano-silicon fire-resistant materials. So as to buy the best equipment and do the best glass!

Nano-silicon composite fireproof glass is made of two or more layers float glass which is perfused with one or more layer of water-soluble inorganic nona-silicon in between. It can satisfy both fire integrity and insulating requirements at the same time.

The fireproof principle of composite fireproof glass:

When the fire occurs, the glass facing the fire exposes to the high temperature would explode quickly, the fireproof glue interlayer begins to foam and expand to a hard opaque fireproof rubber sheet, therefore to effectively block the fire spreading to the another side of the glass, also block the flame heat go through the glass transferring to the back side.

In a fire, nano silicon can always maintain excellent fire integrity. The glass facing fire explodes quickly after being exposed to fire. The unique internal fire-resistant adhesive layer will foam and expand successively with the increase in temperature, and absorb a large amount of flame heat in the process (maintain the back side glass surface average temperature below 140°C), forming an opaque fireproof rubber sheet, effectively blocking high temperature, flame, smoke and toxic gases, providing real safety protection.

Specialty decides quality,
strength builds brand

纳米硅防火玻璃生产线 Nano Fireproof Glass Producing Line

技术参数/Technical Parameters

名称	升降台	平台	炉体	Name	Lifting Platform	Platform	Furnace
长度	5.7m	8.2m	6.1m	Length	5.7m	8.2m	6.1m
宽度	4m	12m	3.2m	Width	4m	12m	3.2m
高度	4m	3m	4.5m	Height	4m	3m	4.5m
功率	10kW		100kW(单个)	Power	10kW		100kW (each)
备注		3个架子, 架子减少宽度可以减小		Note		3 shelves,shelves reduced width reduced	Can put three stove

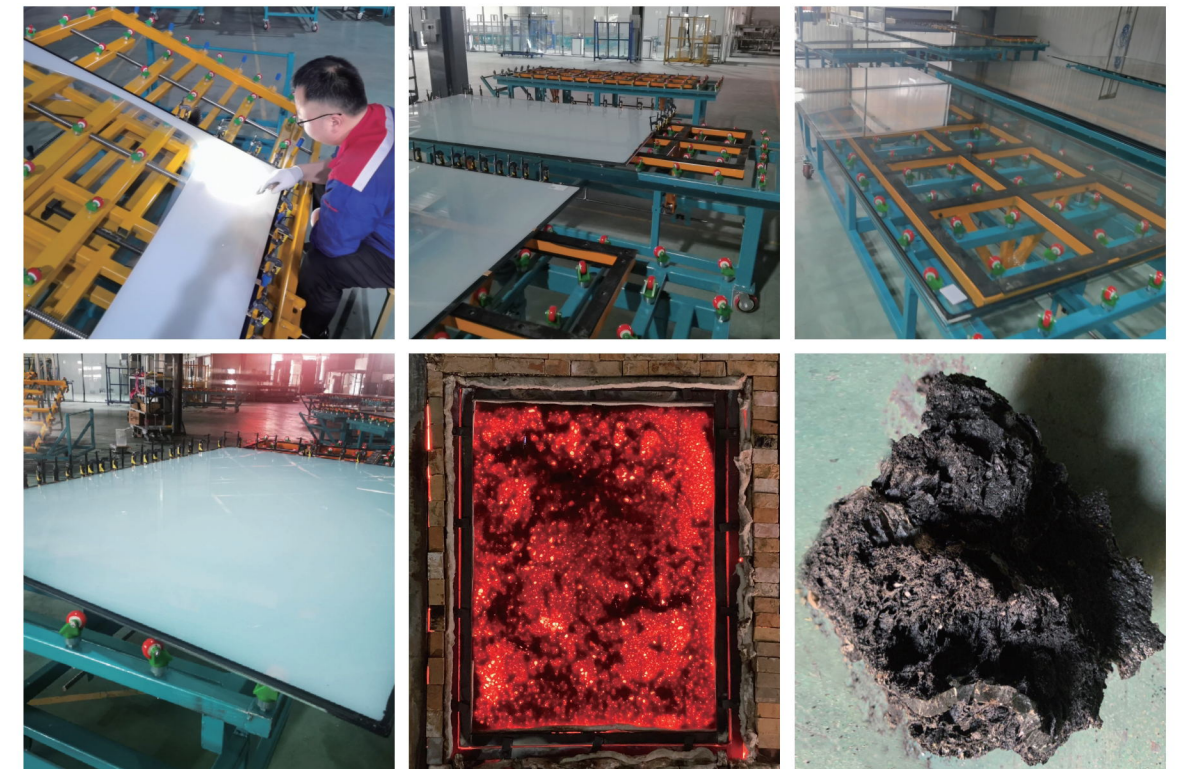

Specialty decides quality,
strength builds brand

烧检炉
Fire Proof Glass Testing Furnace



基本信息/Basic Information

本烧检炉专门用于防火玻璃的烧检,可烧检单片非隔热玻璃、复合防火玻璃、中空玻璃、门窗玻璃等。严格按照国家GB/T9978.1-2008标准制作,满足自检、第三方检测、官方检测要求;满足国标规定时间、规定温度的平稳升温曲线要求;满足国标初始燃烧及稳定燃烧的气压范围要求;针对不同要求增加外部测温点、排烟除尘系统、数据拷贝、远程APP、上位机等。可使用天然气、液化石油气、柴油等。超过国标要求标准,新增安全点火控制,新增热量回收系统,可节约38%的热能。设备有5种安全保护模式,火焰监测装置等。附:常规900*1500基本数据

This furnace is designed for fire-proof burning test, can test on single layer non-insulation glass, composite fireproof glass, insulating glass, door and window glass etc.

The furnace is produced accordance with national 9978.1-2008 standard strictly to meet the self, third-party and official inspection requirements. It meets the requirements of the national standard for a stable heating curve of the specified time and temperature, meets the requirements of the national standard for the initial combustion and stable combustion air pressure range. With different requirements, it adds external temperature measurement points, smoke and dust removal systems, data copy, remote APP, host computers, etc. It can use natural gas, liquefied petroleum gas, diesel, etc. Exceeding the national standard requirements, with new safety ignition control, and a new heat recovery system can save 38% of heat energy. The equipment has 5 safety protection modes, flame monitoring devices, etc.

Attachment: basic data of conventional 900*1500

技术参数/Technical Parameters

型号	烧检炉
占地	2.5mX4.5m
功率	8kW
最大烧检尺寸	900mmX1500mm
热量	360J
Model	Fire Proof Glass Testing Furnace
Covers an area of	2.5mX4.5m
Power	8kW
Maximum test size	900mmX1500mm
Heat quantity	360J

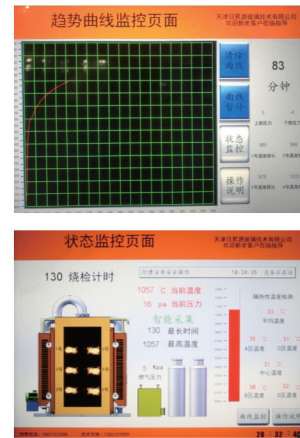

烧检炉
Fire Proof Glass Testing Furnace

产品展示/Product Display



潍坊力创节能



滕州丰华



恒昇源建筑防火科技廊坊有限公司



临朐方正玻璃



四川雄港玻璃有限公司



青海省建筑材料科学研究院

气动吸盘
Pneumatic Vacuum Glass Lifter Sucker

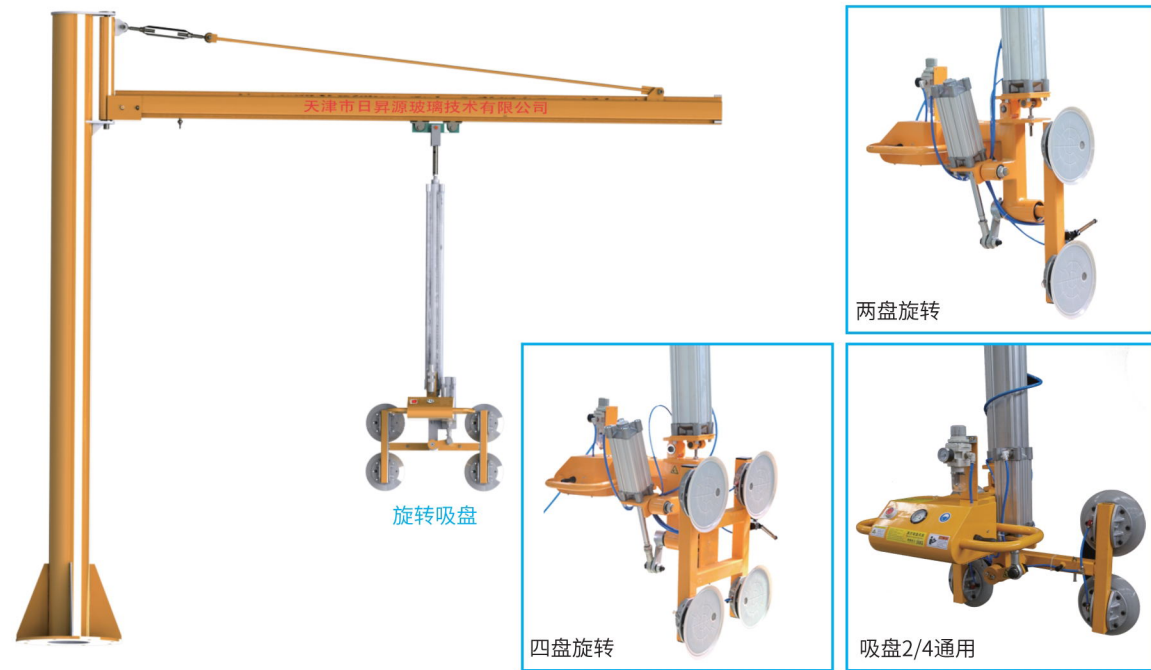

技术参数/Technical Parameters

型号	RSY-XZ350	Model	RSY-XZ350
工作重量	260/350KG	Operating weight	260/350KG
工作角度	翻转旋转90°	Work range	Tilting & Rotating90°
垂直升降行程	1200mm	Vertical lifting range	1200mm
气动元件	日本SMC	Pneumatic componernts	SMC(Japan)
吸盘数量	2/4	Sucker cup qty	2/4
吸盘材质	硅胶	Sucker material	Silica gel

功能: 主要适用于立式玻璃深加工设备上片搬运工序。
Function: Mainly suitable for vertical glass deep processing equipment upper and lower sheet handing process.

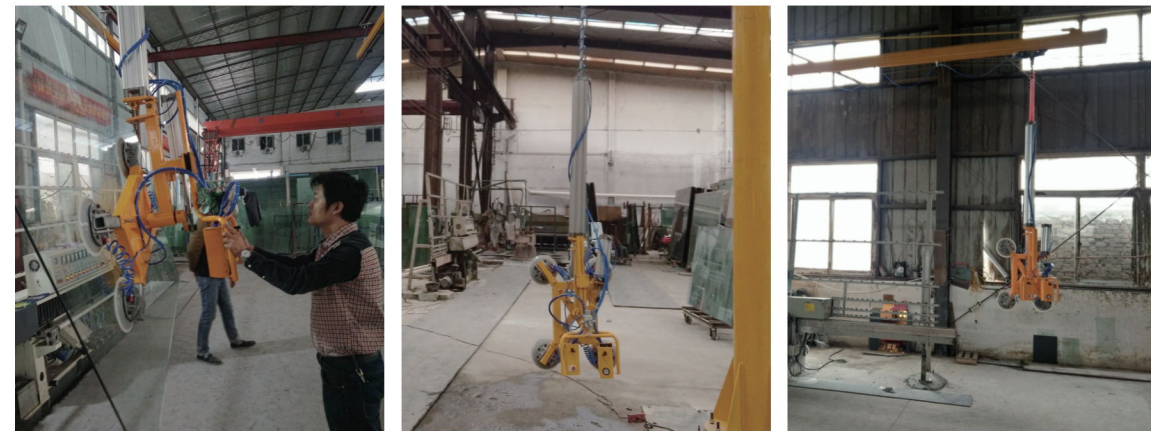

Specialty decides quality,
strength builds brand

气动吸盘
Pneumatic Vacuum Glass Lifter Sucker



技术参数/Technical Parameters

型号	RSY-FZ350/450	Model	RSY-FZ350/450
工作重量	350/450KG	Operating weight	350/450KG
工作角度	翻转90°	Work range	Tilting 90°
垂直升降行程	1200mm	Vertical lifting range	1200mm
气动元件	日本SMC	Pneumatic componernts	SMC(Japan)
吸盘数量	4/6	Sucker cup qty	4/6
吸盘材质	硅胶	Sucker material	Silica gel

功能: 主要适用于卧式玻璃深加工设备上片、钢化炉上下片、双边机的上下片、卧式钻孔机上下片等搬运工序。
Function: Mainly applied to horizontal slice up and down, toughened glass processing furnace, bilateral machine up and down, up and down horizontal drilling machine such as the lower handing process.



Specialty decides quality,
strength builds brand

气动吸盘
Pneumatic Vacuum Glass Lifter Sucker

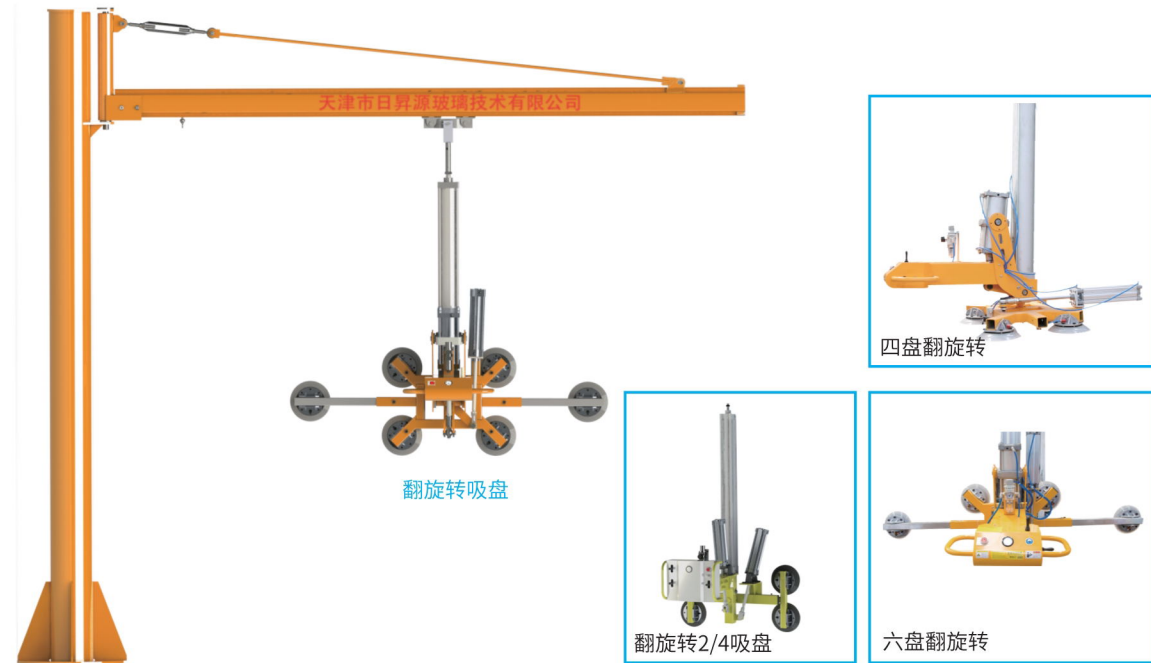

翻旋转吸盘



四盘翻旋转



翻旋转2/4吸盘



六盘翻旋转

技术参数/Technical Parameters

型号	RSY-FXZ350/450	Model	RSY-FXZ350/450
工作重量	350/450KG	Operating weight	350/450KG
工作角度	翻旋转90°	Work range	Tilting & Rotating90°
垂直升降行程	1200mm	Vertical lifting range	1200mm
气动元件	日本SMC	Pneumatic componernts	SMC(Japan)
吸盘数量	4/6	Sucker cup qty	4/6
吸盘材质	硅胶	Sucker material	Silica gel
功能:适用于所有的玻璃深加工设备上片搬运工序。		Function:Suitable for all glass deep processing equipment.	



气动吸盘
Pneumatic Vacuum Glass Lifter Sucker



直边机吸盘(交叉型、H型)
Sucker of straight edge machine (cross type,H type)

小推车吸盘
Trolley sucker

180°旋转吸盘气缸
180°rotating glass sucker

伸缩扶手吸盘
Adjustable handle glass sucker

180°翻旋转吸盘
180°tilting glass sucker

气动180°旋转吸盘
Pneumatic 180°rotating glass sucker

弯钢吸盘(横、竖)
Bending glass sucker(Horizontal,vertical)

金属木料定制吸盘
Customization glass sucker for metal and wood

合片房吸盘
Laminated glass delicate sucker

单缸推车吸盘
Single cylinder trolley sucker

双缸推车吸盘
Double cylinder trolley sucker

合片房吸盘
Laminated glass delicate sucker

电动吸盘 Electrical Glass Lifter Sucker

电动吸盘X型
Electrical Glass Lifter Sucker(X)



四吸盘

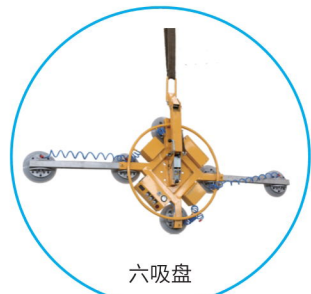

六吸盘



八吸盘

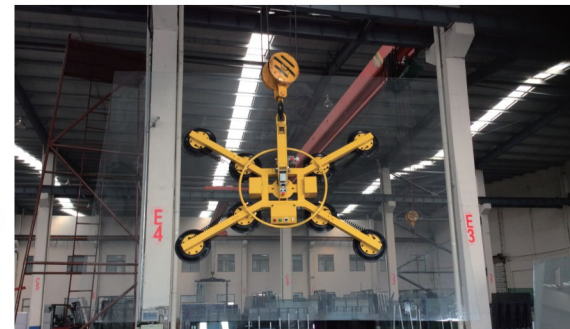

- 1.外形轻巧、操作简单
- 2.12V电池驱动,无需连接外接电源
- 3.可根据玻璃尺寸,加装加长杆
- 4.可手动翻转90°;手动旋转360°
- 5.机械、数显气压及数显电池电量
- 6.全封闭外壳保护,更适合室外幕墙安装使用
- 7.配有真空不足报警及断电保压及报警装置
- 8.意外断电后,保压功能可延长紧急处理时间,使用更安全。
- 9.可根据客户要求,加装遥控装置。

- 1.Light and compact,easier operation.
- 2.Work with 12V battery,no need to connect external power.
- 3.According to the size of the glass, add a lengthening rod.
- 4.Manual tilting 90°and rotating 360° with spring lock positioning.
- 5.Digital vacuum pressure display and LCDbattery volume display.
- 6.Sealed cover for components protection,suited for outdoors use.
- 7.Low pressure alarm with acoustic and light.
- 8.When power cut off,presure maintains give you time to emergency react,keep safe.
- 9.Remote control devices can be installed according to customer requirements.

技术参数/Technical Parameters

型号 (Model No.)	RSY-4	RSY-6	RSY-8
承载重量 (Load Capacity)	500KG	600KG	800KG
承载重量 (Suction Qty)	4	6	8
翻转及旋转方式 (Tilt&Rotation Type)	手动 (Handle)		
翻转角度 (Tilt Angle)	90°		
旋转角度 (Rotation Angle)	360°		
可选配置 (Optional Configuration)	加长杆(Extension rod)/遥控器 (Remote control)		

电动吸盘 Electrical Glass Lifter Sucker

电动翻转电动旋转 Electrical Tilting & Rotating

本产品为大型玻璃幕墙室外安装设计,设备具备电动翻转和旋转功能;设备具有断电保护及真空不足报警功能,使用更安全,并可加装遥控远程控制,更适合高层室外玻璃幕墙安装,我公司可根据客户要求制作适应各种版面及重量的吸盘。

Designed for Jumbo glass,suitable for outdoor screen installation and outdoor jumbo glass movement,it has totating and reversal function.(customer also could choose single rotating and reversal function);the machine has power-off protection and alarm function for lack of vacuum.Make use safely, meanwhile could add telecontrol device,suitable for the glass in top outdoor screen.

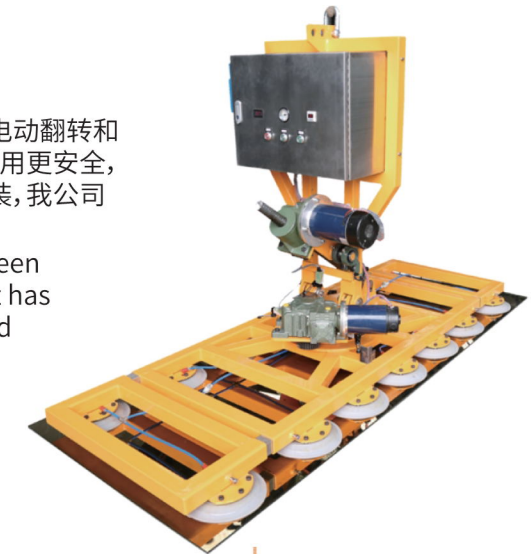

电动翻转手动旋转 Electrical Tilting & Manual Rotating

适用于大板玻璃的取放和翻转,电动翻转90°,手动旋转360°,结构简单,操作方便。

It is suitable for big size of glass for turnover and pick-and-place,electrical turnover 90°, handle rotation 360°,structure easy,convenient operation.

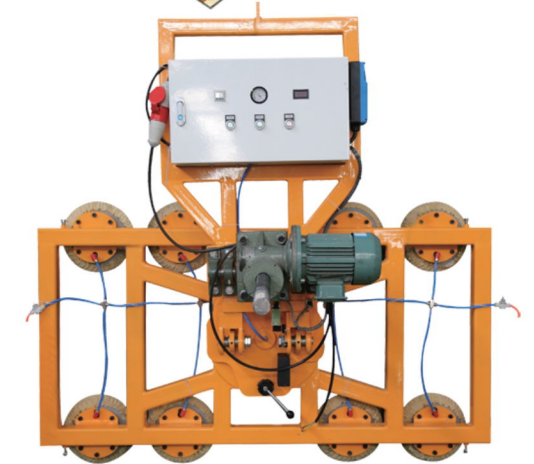

技术参数/Technical Parameters

参数	型号		Model	H-Electrical Glass Lifter Sucker		Hydraumatic Glass Lifter Sucker	
	电动翻转	电动旋转		电动翻转	手动旋转	手动旋转	手动旋转
适用范围	室外幕墙安装、室内大版玻璃搬运等工序,具有旋转翻转功能			Function	Suitable for outdoor screen installation and indoor large-glass movement,it has rotating and tilting function.		
工作电压	DV48V AC380V (可配选)			Operating Voltage	DV48V AC380V(selectable)		
电池续航	15-20小时			Battery Life	15-20Hours		
载重量	1000-1500KG	800-1300KG	Operating Weight	1000-1500KG	800-1300KG	800-1300KG	800-1300KG
垂直旋转	电动旋转360°	手动旋转360°	Rotating	Electric Rotating 360° Hand Rotating 360°			
卧式旋转	电动翻转90°			Turn Over	Electric Tilting 90°		
控制方式	手动/遥控			Control Fashion	Handle/Remote control		
功能	真空泵			Specialty	Vacuum Pump		
真空系统	电压表,断电保护15分钟不脱落功能;气压表,气压不足报警功能			Vacuum System	Voltmeter,15minutes off power protectionfunction;The barometer, insufficient pressure alarm function.		
供气源	电动真空泵压缩空气6-8帕			Air Supply	Electrical vacuum pump compressed air -60~-80kpa		
吸盘个数	10、14 (可定做)	8、10、12 (可定做)	Sucker No.	10/14(customize)	8/10/14(customize)	8/10/14(customize)	8/10/14(customize)
起吊方式	外挂至吊卸工具上			Lifting Way	Plugins to crane unloading tools		

电动吸盘 Electrical Glass Lifter Sucker

液压电动翻转旋转 Hydraulic Electrical & Rotating

适用于超大版超重的玻璃,通过液压站提供翻转旋转的动力,操作稳定,动力强劲。
It is suitable for jumbo glass, which provides the power to rotate through the hydraulic station, stable operation and strong power.

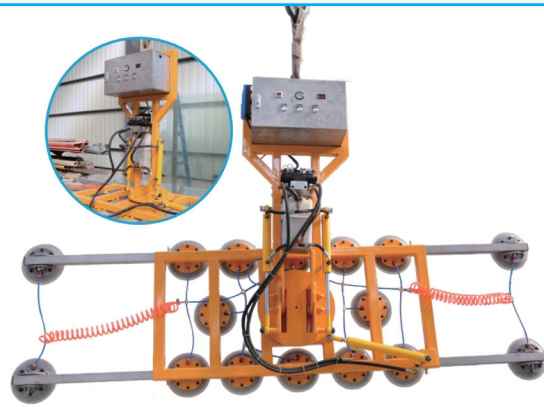

一字手动翻转旋转 Line Type Manual Tilting & Rotating

一字式吸盘专为小型玻璃设计的一款室内外都可以使用的电池驱动式玻璃真空吸盘吊具,设计轻巧灵活,特别适合3.5米长,1.5米宽以内的门窗等玻璃的安装及加工上料。
Line type sucker with battery can be suitable for small size of glass indoor and outdoor, design and lighter. It is suitable for door and window glass within length 3.5 meter and wide 1.5 meter.



超大电动吸盘 Super Large Electric Sucker

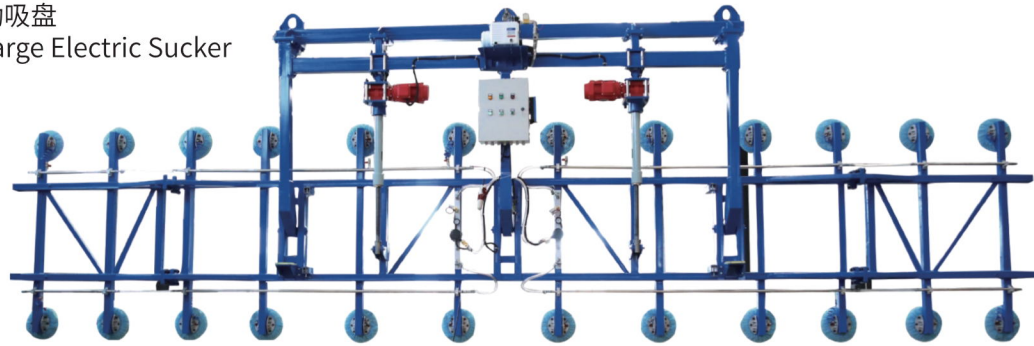

超大中空双夹吸盘 (气动型、电动型) Super Large Hollow Double Clamp Sucker (Pneumatic and Electric)



电动旋臂起重机 Electric Slewing Crane

根据用户需要特殊设计的专用起重设备,具有结构新颖,合理、简单、操作使用方便、电葫芦电动机自动行走、双键升降、360°电动旋转、作业空间大等优点,是节能高效的物料吊运装备,我公司可生产1T-3T起重设备,可配合电葫芦和玻璃吸盘设备进行工作。
Special lifting equipment specially designed according to the needs of users, with novel structure, reasonable, simple, easy to operate, electric hoist motor automatic walking, double key lifting, 360° electric rotation, work large space and other advantages, is energy saving and efficient material lifting equipment, our company can produce 1T-3T starting heavy equipment, can work with electric hoist and glass sucker equipment.



玻璃鱼缸专用吸盘 Vacuum Glass Lifter Dedicated for Fish Tanks

采用电动吸盘结构,吸盘吊臂间距可调,方便搬运不同大小的鱼缸,可用叉车直接搬运,也可用天车起吊搬运。
Adopting the Structure of Electrical Glass Lifter, adjustable distance between the vacuum glass lifter arms, convenient to carry different sizes of fish tanks. It can work with a forklift truck, it also can be lifted up with an overhead crane.



夹层玻璃生产线合片专用吸盘
Laminated Glass Dedicated Sucker



Hand trolley

技术参数/Technical Parameters

型号	RSY-LMJ350-450
工作重量	350KG、450KG
吸盘数量	4/6/8
垂直升降行程	500mm可根据客户需求定制
工作气源	0.6-0.8Mpa
工作角度	可360°旋转,前、后、左、右移动
功能	主要适用于夹层玻璃生产线合片工序,合片精准,比传统的剪式吸盘吊具合片快3倍。
Model	RSY-LMJ350-450
Operating weight	350KG/450KG
Sucker No.	4/6/8
Vertical lifting range	500(customized)
Air supply	0.6-0.8Mpa
Work Angle	Rotating 360°
Function	Mainly used in laminated glass production line,fast speed and precise work.

龙门架式真空吸盘
Protal-Frame Shape Vacuum Glass Sucker



技术参数/Technical Parameters

型号	RSY-LMJ350-4、450-4	Model	RSY-LMJ350-4、450-4
工作重量	350kg、450kg	Operating weight	350kg、450kg
工作角度	翻转旋转90度	Work range	Tilting,rotating 90°
垂直升降行程	1200mm	Vertical lifting range	1200mm
工作气源	0.6-0.8Mpa	Air supply	0.6-0.8Mpa
吸盘数量	4、6个	Sucker No.	4/6
优点	覆盖面积大,受力比悬臂吊均匀,做超大版玻璃灵活轻便。	Advantage	Larger coverage,power equality, suitable for large glass and easy to use.
功能	适用于夹层玻璃生产线、钢化玻璃生产线、中空玻璃生产线、磨边机、装卸玻璃等工序。	Function	Mainly used in laminated glass production line,tempered glass,Hollow glass,glass edge grinding machine, loading and unloading glass ect.

电动吸盘车 Electric Glass Robot



RSY-400标准型

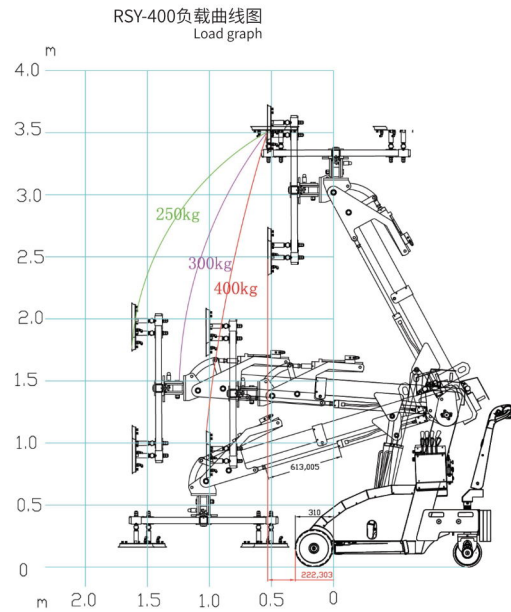

基本信息/Basic Information

采用真空抽吸原理,包括行走、举升、翻转旋转等功能,可以轻松实现玻璃的移动和搬运。该机器重量轻、操作灵活,是一种节能、高效、环保的新型玻璃搬运机械。广泛应用于,玻璃幕墙、石材、板材安装等场景。在工厂、仓库、物流中心许多地方,玻璃的搬运安全高效,充分体现了其优异的灵活性、稳定性和环保性能一人即可操作,节约人工成本,提高工作效率

It adopts the principle of vacuum suction, which includes the functions of walking, lifting, tilting and rotation, which can easily realize the moving and handling of glass.

This machine is light and flexible in operation, and it is a new type of glass handling machinery with energy saving, high efficiency and environmental protection.

It is widely used in curtain wall glass installation, stone slab and plates transportation. In factories, warehouses, logistics centers and many other places, the handling of glass panels is safe and efficient, and fully reflects its excellent flexibility, stability and environmental protection performance.

One person can operate, saving labor costs and improving engineering efficiency

技术参数/Technical Parameters

型号	RSY-400标准型		RSY-800标准型	
举升高度 (max)		3.5m		4.5m
最大起重量 (max)		400KG		800KG
驱动方式	24V电机前驱	2.2KW	24V电机前驱	2.2KW
爬坡能力		15%		15%
行驶速度 (max)		5km/h		5km/h
真空吸力 (max)		400KG		800KG
吸盘数量	Φ300mm	6个	Φ500mm	6个
真空泵	24V真空泵	2路	24V真空泵	2路
真空警告提示	数显&机械	自动真空保持、蜂鸣报警 机械压力表	数显&机械	自动真空保持、蜂鸣报警 机械压力表
前臂伸缩距	液压	600mm	液压	2*550mm
翻转角度	液压	0-135°	液压	0-135°
左右平移	液压	±50mm	液压	±50mm
侧扭角度	手动	±90°	液压	±90°
旋转角度	手动	360°每45°可锁止	液压	360°无极旋转
电池型号	DC12v 100AH	2组	DC12v 150AH	2组
续航能力		4-8H		4-8H
设备重量		1060kg		1960kg
外形尺寸		长2.4m*宽0.8m*高1.4m		长3.2m*宽1.2m*高1.4m
包装箱尺寸	400kg	2.5*1.0*1.9		3.2*1.3*1.9

电动吸盘车 Electric Glass Robot

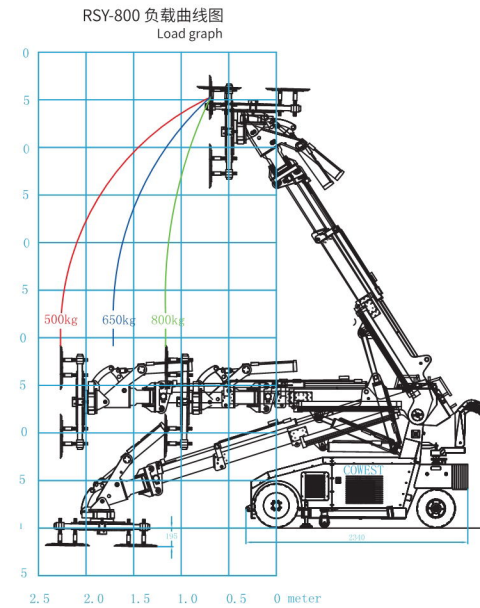

RSY-800标准型



Model	RSY-400(Standard type)		RSY-800(Standard type)	
Loading high (max)		3.5m		4.5m
Loading capacity (max)		400KG		800KG
Driving method	24V motor front drive	2.2KW	24V motor front drive	2.2KW
Climbing ability		15%		15%
Driving speed (max)		5km/h		5km/h
Vacuum suction (max)		400KG		800KG
Suction pad NO.	Φ300mm	6 Pcs	Φ500mm	6 Pcs
Vacuum pump	24V vacuum pump	2 pcs	24V vacuum pump	2 pcs
Vacuum warning prompt	Digital Display &Mechanical	Automatic vacuum holding, buzzer alarm, mechanical pressure gauge	Digital Display &Mechanical	Automatic vacuum holding, buzzer alarm, mechanical pressure gauge
Forearm telescopic distance	hydraulic pressure	600mm	hydraulic pressure	2*550mm
Tilting control	hydraulic pressure	0-135°	hydraulic pressure	0-135°
Left and right translation	hydraulic pressure	±50mm	hydraulic pressure	±50mm
Lateral torsion angle	Manual	±90°	hydraulic pressure	±90°
Rotation control	Manual	360°, Lockable every 45°	hydraulic pressure	360°
Battery	DC12v 100AH	2 Pcs	DC12v 150AH	2 Pcs
Charging time		4-8H		4-8H
Total weight		1060kg		1960kg
Size		2.4m*0.8m*1.4m (L*W*H)		3.2m*1.2m*1.4m (L*W*H)
Packing box size	400kg	2.5*1.0*1.9		3.2*1.3*1.9

新X-02双磨头磨边机 New X-20 Double Head Edge Grinding Machine



本磨边机是我公司第六代磨边机,采用四边磨磨边原理及结构,磨轮可前后调节,能满足不同规格玻璃的磨边需要。磨轮可使用市场通用的金刚轮和树脂轮,更换速度快,使用时间长,磨边效果细腻,磨边后不崩边,钢化自爆率低。可正面或侧面连线洗片机直接清洗。且该机具有水式除Low-E膜装置,两侧的活动平台可根据磨边需要任意折叠。可根据客户要求,加装磨底边装置。

This is the sixth generation edge grinding of our company machine,using quads sharpen edges principle and structure,with a buffer device,grinding wheel can move around,to meet the needs of the various specifications of glass edge grinding.Grinding wheel can use market diamond and resin wheel,change fast,long using time,edge grinding effect is exquisite.Reduce the rate of destruction for tempered glass.Attact can positive or side wash machine wash directly.And the machine has type low-e coating removal equipment,activities on both sides of the platform can be arbitrary disassemble combination according to the edge grinding.Also could install the device to grind bottom margin.

技术参数/Technical Parameters

型号	RSY-NX-02	Model	RSY-NX-02
功率	3.1KW	Power	3.1KW
外形尺寸	2800*1250*1270 (mm)	Overall size	2800*1250*1270 (mm)
适应厚度	3mm-12mm	Adaptive thickness	3mm-12mm
最小加工尺寸	300*300 (mm)	Minimum processing size	300*300 (mm)
最大加工尺寸	2000*2000 (mm)	Maximun processing size	2000*2000 (mm)



RSY-08A多功能磨边机 RSY-08A Multifunctional Edge Grinder

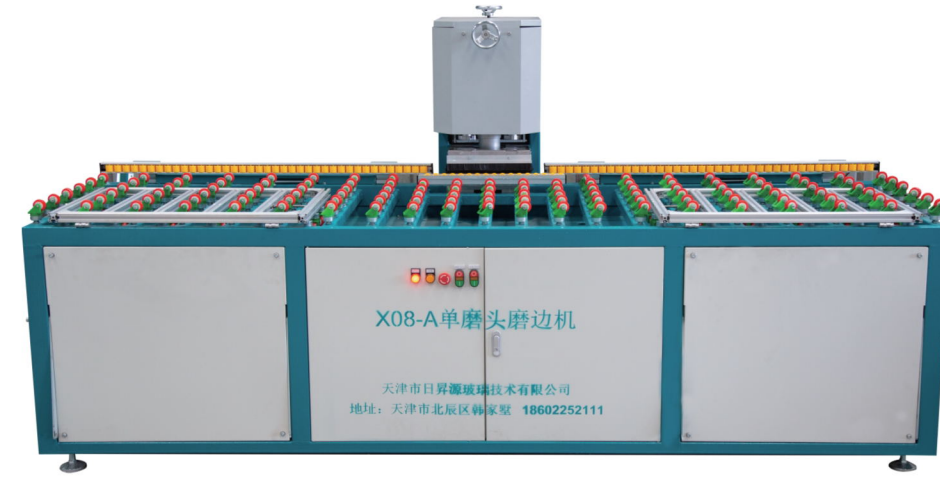

- 1.对加工玻璃圆角,汽车挡风玻璃尤为适用。
- 2.不同规格的玻璃可连续上片,无须人工调整 and 等待。
- 3.本机可测正、面连线洗片机,使玻璃从磨边机到洗片一步到位,节约人力和时间,并且不妨碍原有连线的四边磨等机械设备。
- 4.本机解决了玻璃在加工时所带来的磨边粗糙、入高温炉易裂、二次碎屑划伤等问题。轻松快速完成直边、圆边、三角形、波浪形等异形磨边。

- 1.Better grinding speed and effect than quad-edge grinding machine.Better than double-edge grinding machine in grinding complicated,single and irregular glasses.
- 2.Put glass continuously even for different specification without manual adjustment and attention.
- 3.Connect the glass washing machine form front and side,making one-step-to-reach form grinding to washing,this saving manpower and time.No interference with connected machines or devices.
- 4.This machine completely gets rid of the disadvantages of same devices such as rough grinding and explodes easily when glass is put in high temperature stove,or secondary debris scratches.It can finish irregular grinding movement to straight,round,triangle or wavy edge.

技术参数/Technical Parameters

型号	RSY-08A	Model	RSY-08A
功率	2.3KW	Power	2.3KW
玻璃厚度	3mm-12mm	Glass thickness	3mm-12mm
机器外形尺寸	2840*1250*850(mm)	Overall dimensions	2840*1250*850(mm)
最小加工尺寸	280*280(mm)	Minimum processing size	280*280(mm)
最大加工尺寸	2000*2000(mm)	Miaimum processing size	2000*2000(mm)

水式砂带机 Water Type Belt Machine

该机为A款的升级产品,在具有A款功能的基础上,在平台上加装了靠轮,使玻璃在磨边时可直线通过,倒角的磨削量规整统一;在主机上增加偏心轮装置,既能调节砂带装置、张紧度,也能适当调整玻璃磨削角度。

This machine is upgrade product of water type belt machine A,then the glass could through in a straight line when grinding,the grinding of chamfer is orderly and neat.This machine add eccentric wheel on mainframe,not just could adjust the position of abrasive belt,degree of tightness.But also could adjust grinding angle of glass.

技术参数/Technical Parameters

型号 Model	RSY-SDMBJ03A	RSY-SDMBJ03C
主机外观 Host apperance	700*700*1300(mm)	700*700*1300(mm)
功率 Power	1.6KW	1.6KW
平台外观 Platform appearance	2200*1200(mm)	2200*1200(mm)
最小加工尺寸 Minimum processing size	200*200(mm)	200*200(mm)
最大加工尺寸 Maximum processing size	2000*2000(mm)	2000*2000(mm)

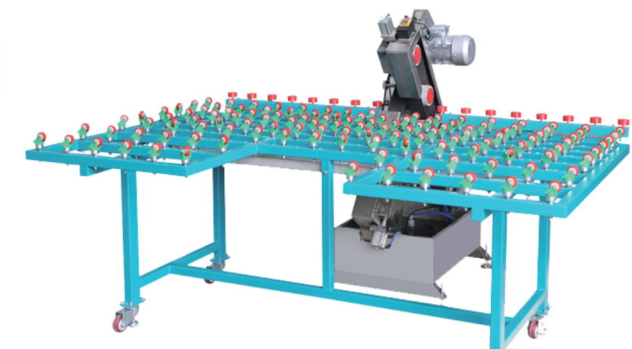

经典式叉车吊臂 Classic Forklift Truck Crane Arm



可配合吊杠吊带等做货物的装卸、移位。
It can cooperate with the glass belt and glass hanging bar to do the goods loading,unloading and displacement.



高度:2.6m 前臂长:2m 宽度:920mm

底座式叉车吊臂 Base Forklift Truck Crane



对于货叉使用率比较高的地方,该吊臂不用频繁装卸货叉,可直接插入使用,玻璃靠住底座架后,在不需人扶的情况下可做远距离移位。
This equipmet suitable for forklift and crane dismounting frequently.It can insert the forklift easily and keep stable when holding the glass and moving it.



高度:2.7m 前臂长:1.45m 底座:1.3*1.3

新式叉车吊臂 New-style Forklift Truck Crane Arm



该吊臂来自欧美设计理念,使用材质加大加厚,并对承重部位做出三角形支撑,对于超重型物尤其适用。
The crane arm is form western design concept,the use of the material increased thickening,and the bearing parts to make triangle support,especially applicable for super-heavy goods.



高度:2.7m 前臂长:2m

吊杠置顶式叉车吊臂 Hanging Bar Set-top Folklift Truck Crane Arm



该吊臂可以在库门或车间矮小的地方,进行装卸移位。
Suitable for loading and unloading displacement in warehouse,doors or short workshops.



高度:2600mm 臂长:2000mm

U型吊臂
Container U-Shape Suspension Arm



U型吊臂广泛用于玻璃厂车间、车站、码头、远洋货运等集装箱吊运玻璃的场所。此装置可轻松起吊20英尺普柜、高柜的大小版玻璃。不需要两台大吨位叉车混合作业。此设备不会造成玻璃的破损，不需要拖拉木箱，不损坏集装箱体，装卸成本低，安全可靠，可结合天车、吊车使用，既能充分利用场地，又不受场地限制。产品分为A/B两款，B款可装卸大小版面玻璃；A款可装卸大版面玻璃。

Container U-Shape Suspension Arm is widely used in glass factory workshop, station, wharf and places where ocean freight containers need to be lifted. This equipment ingeniously uses mechanical balance principle and is able to lift 20-foot glass whose size is similar to the standard and high cube container. There is no need for manual coordination or forklift truck. Also, it can make no damage to glass and container making it safe and reliable to use. The arm makes the cost lower, economically uses the field and exploits the driving advantages. This product is divided into two types, B type could load big and small glass, and the A type just could load big glass.

技术参数/Technical Parameters

型号	RSY-UDB-02	RSY-UDB-01	Model	RSY-UDB-02	RSY-UDB-01
起重量	2700kg	2700kg	Lifting weight	2700kg	2700kg
上臂长	8850mm	7150mm	Arm length	8850mm	7150mm
下臂长	6000mm	5800mm	upper arm length	6000mm	5800mm
工作范围	适应大小版面玻璃装卸	适应大版面玻璃装卸	Lower arm length	Suitable for big size glass	Suitable for big size or small size glass



叉车串杆
Forklift Truck Skewer



技术参数/Technical Parameters

型号	RSY-CCCG-01	Model	RSY-CCCG-01
起重量	2700kg	Lifting weight	2700kg
臂长	6000mm	Arm length	6000mm
自重	900kg	Dead load	900kg
工作范围	适应大小版面玻璃装卸	Working range	

叉车串杆是专业装卸集装箱玻璃的工具，其购置费用低廉，不需要对叉车进行任何改动即可安装，能适应大小版面玻璃的装卸，充分发挥叉车性能优势，突破场地区域限制，随时作业。本产品具有结构合理，操作方便，工作效率高，免维护等优点。

Forklift Truck Skewer is a specialized loading and unloading container glass tool. It has low purchasing cost and can be installed without any changes to forklift truck. It is adapted to the loading and unloading task of glasses in different sizes, thus making full use of proper structure, easy to operate, high performing efficiency and free of maintenance.



玻璃上片台C款
Glass-loading Table C Type



本机是一款非常适用的玻璃取片、切割、气浮、掰片一体机，设备可360度旋转、遥控行走可自由移动；上片台自动变频安全可靠，内置大功率空压机，无需再附加气路；气缸壁由进口真空调压开关控制上面才可直接把玻璃放于台面，无需移动设备，更加安全可靠。该机有半自动和全自动两种工作模式，半自动根据需求点动，全自动模式下可一键完成玻璃上片工作。
The machine is a very suitable glass pick-up, cutting, air-floating and smashing machine. The machine can be rotated 360 degrees, and the remote control can move freely. The automatic conversion of the upper table is safe and reliable, and the built-in high-power air compressor does not need additional air path; the cylinder wall is controlled by the imported real air conditioning pressure switch to directly put the glass on the table top, no need for mobile equipment, more safe and reliable. The machine has semi-automatic and fully automatic working modes, semi-automatic jog according to demand, and full-automatic mode can complete the glass film work with one button.

技术参数/Technical Parameters

型号	RSY-SPTA/C	Model	RSY-SPTA/C
外观尺寸	2100*3600*800 (mm)	Overall Appearance Size	2100*3600*800 (mm)
最大加工尺寸	2800*3660 (mm)	Maximum processing size	2800*3660 (mm)
最小加工尺寸	1830*2440 (mm)	Minimum processing size	1830*2440 (mm)
适应厚度	3-19mm	Adaptive thickness	3-19mm
功率	7kw	Power	7kw

玻璃专用吊带
Glass Sling



底座和防割层实际使用细节图

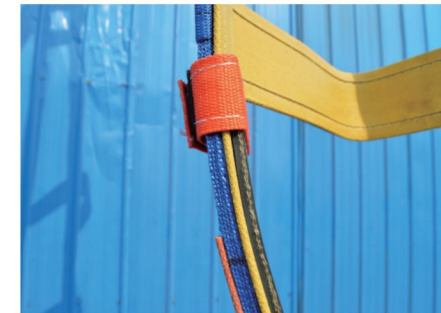

防割层粘布细节图



瑞士进口织带机



R角线切割钢制底托
终身使用，受力均匀，完美负荷
390*100*14
200*100*14



新式防割层
对吊带、玻璃双向保护
900*100*8
500*100*6

天津市日昇源玻璃技术有限公司从事玻璃行业30年，经过不断改进优化，生产出了中国质量最好、设计最合理的玻璃吊带。本产品采用高强度涤纶丝为承载芯，同时在内层玻璃接触部位添加了两道高新技术材料作为防割层，耐割耐磨，并独创设计了可终生使用的R角全钢板底座，产品设计符合力学原理，分散负荷，细节完美。该吊带比同类产品重9公斤，使用寿命可延长2倍，本产品已申请国家专利(专利号：201430200860.0)保护，并由太平洋保险公司承保。

Tianjin Rishengyuan Glass Technology Co., Ltd has engaged in the glass industry for 30 years. After continuous improvement and optimization, the company has manufactured the best quality and design slings in China. The slings utilize high-intensity polyester tread as the bearing core, and add high-tech materials in the inner glass contact area as the anti-cutting layer. Also, it originally creates the R-angle full-steel plate base which can be used in the lifetime. This design product conforms to mechanics principle to distract weight with perfect details. It weighs 9 kilograms heavier than the same products and has more than 2 times longer service time. The company has already applied for national patent protection (Patent No. 201430200860.0) and is underwritten by Pacific Insurance.

新式吊杠 New Type Hanging Bar

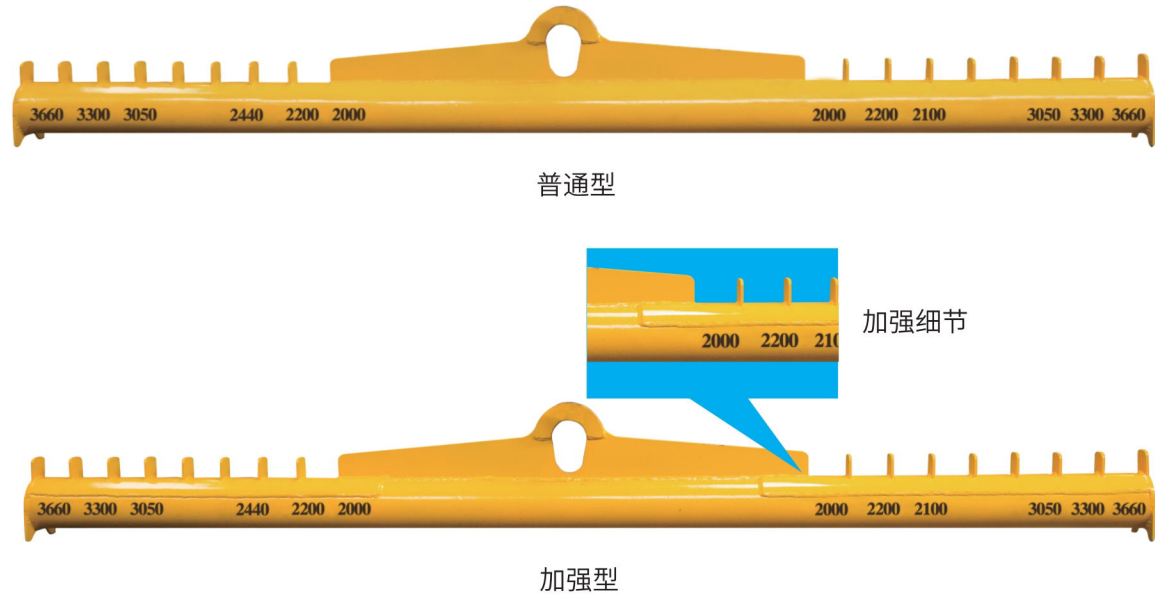

该吊杠集中了其它多款吊杠的优点,根据常规玻璃板面的差异化(如长度3300和3660的玻璃与宽度10CM吊带的兼容性),根据力学原理设计,精密计算出纵向和横向的承载力量,用3D设计出具有完美主义的新式吊杠,该吊杠可适应长度2000mm-3660mm常规版面的玻璃。无缝钢管直径增加至146mm,工业级的而保焊机深层熔透焊接,焊点打磨精细,不会损伤吊带,确保使用的安全性。表面使用环氧漆处理,防锈防蚀,防紫外线,附着力强,使用寿命长。在挂带的每个档位有醒目的规格标注,使用更省心。可更具客户要求,特殊定制。

New Type Hanging Bar concentrated many advantages of other Hanging Bars.It is designed by 3D according to different sizes of glass that is from 2000mm - 3660mm.The diameter of seamless steel tube is increased to 146mm. It is made by carbon dioxide welder which make the welding fine.The surface of the tool is processed by epoxy paint, rust resistance,corrosion resistance.It could be customized according to customer's requirements.

技术参数/Technical Parameters

型号 Model	RSY-XSDGO8	Model	RSY-XSDGO8
长度 Length	3200mm	Length	3200mm
档位数量 Number	八档	Number	Eight
直径 Diameter	146mm	Diameter	146mm
可吊玻璃长度 Glass length to lift	2000、2200、2400、3050、3300、3600 (mm)	Glass length to lift	2000、2200、2400、3050、3300、3600 (mm)



意大利LC吊夹 LC Glass Clamp

技术参数/Technical Parameters

型号 Model	RSY-YDLDJ1000(橡胶型、软木型) RSY-YDLDJ1000(Rubber type/Cork type)
尺寸 Size	224*740*654(mm)
提升重量 Lifting weight	20-800kg
加持厚度 Glass thickness	4-19mm
开口度 Opening size	44mm
自重 Self weight	25kg



该吊夹秉承意大利设计理念,精美的做工和稳定的性能使其在国际上具有良好的声誉。压铸铝件保证了作业时需要的强度;压铸铝件与天然橡胶热熔在一起,保证了橡胶与铝件不会剥离;天然橡胶保证了对玻璃的亲附着力,永远不会滑落;腿部设计了八个聚氨酯脚轮,外部四个轮方便作业时靠着外围玻璃滑动,内部四个轮确保被夹玻璃沿轮子滑入,不会触碰铝件和橡胶。

The clamp with fine workmanship and stable performance make it has a good reputation in the world.Die-casting aluminum ensures the strength needed for the job;Die-casting aluminum with natural rubber guarantees the rubber and aluminum not stripping;Natural rubber to ensure the affinity of glass adhesion,never slip;Eight polyurethane casters at the bottom of the clamp make the glass slip in easily and will not touch the aluminum or rubber.

全自动鳄鱼吊夹 Full-automatic Glass supporting clamp

该吊夹是在原先半自动吊夹的基础上经过精心设计的升级产品。产品的外观采用特殊工艺处理,整体流畅靓丽。核心的棘轮机构小巧精准,转动灵活,吊夹松开和闭合的过程无需手动辅助,只需随天车的升降完成开闭动作,使用轻松自如,更能保障使用的安全性。

The clamp is on the basis of the original semi-automatic glass supporting clamp carefully designed improved the upgrading of products. The appearance of the products with special process,the overall smooth and beautiful,the core ratchet mechanism of small precision,flexible rotation,no manual clamps loosen and closed process,only complete with crane lift opening and closing operation,use at ease,can guarantee the safety of use.

技术参数/Technical Parameters

型号 Model	RSY-QZDDJ5000
提升重量 Lifting Weight	500kg
加持厚度 Glass Thickness	4-19mm
自重 Self Weight	17.5kg
外观尺寸 Dimensions	250*260*560 (mm)
建议起吊片数 Recommended lifting pieces	1片 1Piece

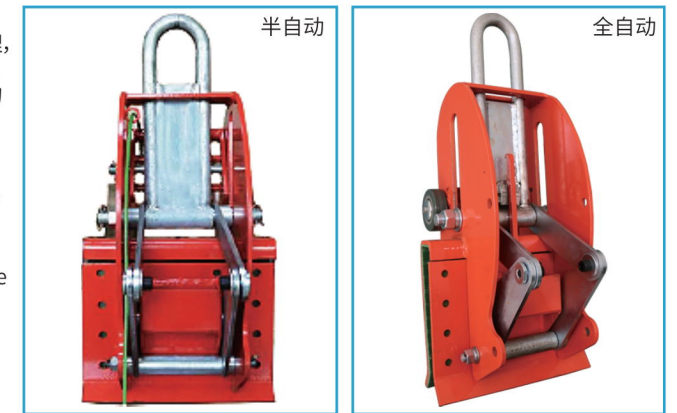

气浮式除膜机 Air Floating Film-Removing Machine



该机为变频Low-E玻璃除膜机,采用双轨道设计,运行稳定。除膜轮对玻璃的压力可通过气缸气压调节,达到干净彻底的除膜且不会烧伤玻璃。除膜的宽度可通过底部手轮进行精准的调节,全自动时,可根据玻璃版面大小调节限位挡的距离,从而实现机头在此区域左右移动,对于熟练的工人可通过变频器调节进行的速度。半自动时,可人工控制机头的运行,随心所欲的停止或作业。气浮机构使玻璃旋转更加轻松自如。

The Air floating Film-Removing machine is frequency conversion Low-E glass film-removing machine,adopting dual track design,stable operation.The pressure form film-removing wheel to glass can be adjusted by cylinder in order to remove the film completely meanwhile protect the glass form burn.The removal film's width can be precisely adjusted by the bottom handwheel and scale.Under fully-automatic mode,distance of the stop block can be adjusted according to the size of the glass in order to ensure the moving of handpiece in this area;for skilled workers,they can adjust the speed of operation through the inverter.Under semi-automatic mode,you can manually control the operation of the handpiece,arbitrary stop or work.The air float structure makes the glass spin more easily.

技术参数/Technical Parameters

型号	RSY-CM-QF04	Model	RSY-CM-QF04
外观尺寸	3000*1550*1080 (mm)	Overall appearance	3000*1550*1080 (mm)
运行模式	全自动和半自动	Running mode	Fully-automatic and Semiautomatic
机头运行距离(最大)	2440 (mm)	Running distance (Maximum)	2440 (mm)
功率	1.6kw	Power	1.6kw

双磨头除膜机 Double Head Film-Removing Machine



技术参数/Technical Parameters

型号	RSY-CM-QF04
外观尺寸	3000*1550*1080 (mm)
运行模式	全自动和半自动
机头运行距离(最大)	2440 (mm)
功率	2.35kw

该机主要用于对镀膜玻璃周边除去镀膜层以适应做中空玻璃的要求。相邻两边同时除膜,生产效率高,除膜宽度、厚度可调。该机采用双轨道设计,运行稳定;具有半自动、全自动两种模式,生产更高效。

The machine is mainly employed to remove the coating layer on the edges of the coated glass so that the glass can adapt to the requirements of hollow glass.It can remove membranes on two adjacent eddges at the same time,which significantly increase the efficiency;the membrane removal width and thickness can be adjusted.This machine adopts a dual-track design and it runs steadily.It features semi-automatic and fully automatic modes which visibly bring up the productive efficiency.

万向轮式除膜机 Universal Wheel Film Removing Machine

技术参数/Technical Parameters

型号	RSY-CM-WXL03
功率	0.75kw
整体外观	2000*1450 (mm)
Model	RSY-CM-WXL03
Power	0.75kw
Overall appearance	2000*1450 (mm)

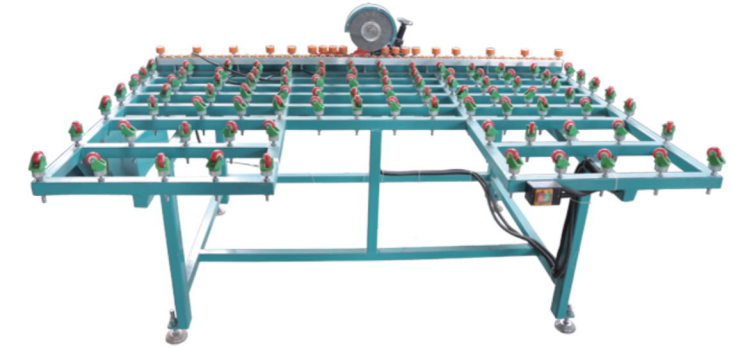

该机轻量化设计,设备性能稳定,机头采用气缸式或弹簧式缓冲式结构,人工推动玻璃,结构简洁,除膜效果好,工作台采用聚氨酯万向轮,转向灵活,不划伤玻璃,使用灵活方便。

Lightweight design,stable equipment performance,the head adopts cylinder type or spring type buffer structure, manual push glass, simple structure, good effect of removing film, working table with polyurethane universal wheel, flexible steering, not scratch the glass, flexible and convenient to use.

双手持Low-E除膜机 Offline Low-E Glass Film-removing Machine

技术参数/Technical Parameters

型号	RSY-C200
转速	660-3000r(mm)/min
功率	1200w



该除膜机结构简洁、使用灵活、性能稳定、除膜效果好、加工范围广且不损伤玻璃表面。

This machine has simple structure, stable performance and fine-removing result without damaging the glass surface. It is flexible to operate and widely used.

单手持Low-E除膜机 One-hand Operation Low-E Coating Removing Machine

该除膜机结构简洁,功率强劲,可单手长时间操作,大大降低工人劳动强度,除膜轮价格低廉易购,其稳定的性能及较高的性价比深受各大中小型Low-E玻璃加工企业喜爱。

The machine can be operated by one hand for a long time.This can reduce the worker labor strength.It is popular with Low-E glass processing enterprises.

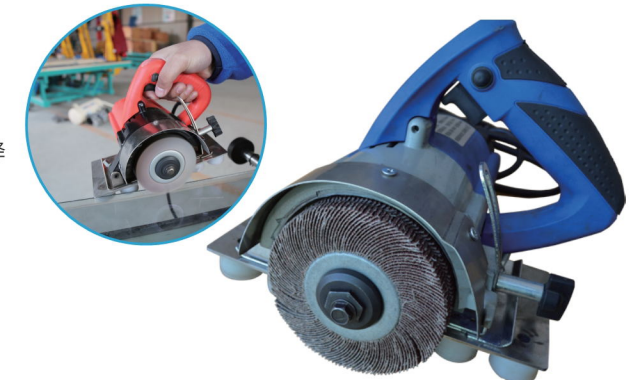

L架 L Shape Shelf



天车吊装



叉车装卸



地牛搬运

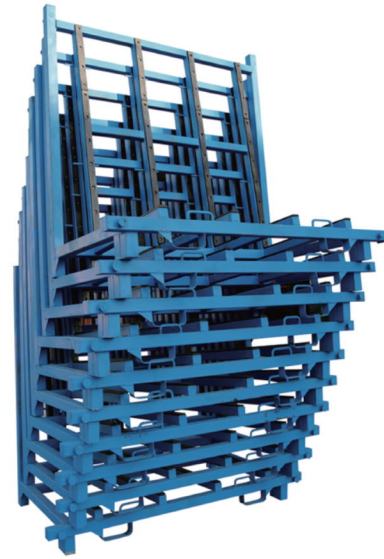

多个叠放、节约场地、方便运输



贯穿焊接



自动锁紧带

25mm
40mm
50mm

鼎安达牌玻璃存放架,包括L架、A字架、原片放置、切片机上片架等。L架是集仓储、搬运于一体的多功能玻璃存放架,是存放零散裁片或中空成品玻璃的首选。架子角度严格控制在90度,刚下线的中空玻璃绝对不会产生滑片。该架子既可用地牛、叉车进行平稳移位,也可用行车直接装卸,闲置或回空运输时一摞可叠加10个,节省库存货运输空间,提高仓库利用率。

DingAnDa Glass Stock rack includes L-shape shelf and raw glass stock rack L-shape shelf a multi-functional glass stock rack integrating and transport all-in-one. It is the first choice to store fragmented glass or finished glass. Shelf angle strictly controlled at 90 degrees, so it will never be slipped for the hollowed glass. With crown block and forklift truck, it can move glasses with great stability. And also can be directly handing by crane. The shelf can be overlaid one by one to save storage space, transport space and improve utilization rate if warehouse.

常用规格/The Regular Specification

- 1、长 1800x 高 1600x 宽 820mm, 玻璃有效存放厚度达 540mm, 小巧灵活, 适合小货车架子背对背运输。
- 2、长 1800x 高 1600x 宽 980mm, 玻璃有效存放厚度达 690mm, 适合中型货车运输。
- 3、长 1800x 高 1600x 宽 1180mm, 玻璃有效存放厚度达 890mm, 适合大型货车运输。

- 1、Length 1800*Height1600*Width750mm, effective glass storing thickness reaches 540mm, exquisite and agile, suitable for small truck transport shelf back to back.
- 2、Length 1800*Height1600*width950mm, effective glass storing thickness reaches 690mm, suitable for middle truck transport.
- 3、Length 1800*Height1600*width 1150mm, effective glass storing thickness reaches 890mm, suitable for big truck transport.

玻璃架子皮子/Glass Shelves Leather

我公司生产的玻璃架子垫皮,采用优质橡胶制作,质地软硬适中,内置加厚钢板。钉孔直径按小孔设计,使燕尾钉被橡胶包裹,避免玻璃磕碰。在制作常规 L 架时,常规皮子长短适中,免于切割拼接。

Our company produced the glass shelf mat leather with high quality rubber, moderate hardness, built-thick steel plate. Nail hole diameter orifice design, dovetail staples are rubber-coated to prevent glass bump. In the production of conventional L shelf, conventional leather moderate length without cutting stitching.



- T12*85*440
- T10*40*430
- T10*40*540
- T10*40*700
- T10*40*900

常用规格/The Regular Specification
40mm*540mm*10mm 40mm*430mm*10mm
40mm*700mm*10mm 40mm*900mm*10mm
40mm*440mm*10mm

L架速压杆 L Rack Fixed Bar



L架分层倒片杆



L架速压杆

L架速压杆/L Rack Fixed Bar

避免玻璃在车间搬移过程中发生倾倒。可快速安装、拆卸,省去传统绳索捆绑时间,提高效率。

Avoiding the glass slip when removing. Installing and Disassembly more quickly and effective.

L架倒片杆/L Frame Layered Rewinding Rod

专为玻璃深加工企业玻璃倒片找片,不同规格玻璃同一架子分层摆放使用。此杆方便、快捷、实用,使用安全,能充分利用架子,节约占地空间。

It is specially designed for glass deep processing enterprises to rewind and find pieces of glass, and different specifications of glass are placed in layers on the same shelf. This rod is convenient, fast, practical, safe to use, can make full use of the shelf, and save space.

玻璃精品架 High Quality Glass Shelf

本产品广泛用在高端玻璃、中空玻璃配对等放置要求较高的场所,它能保证玻璃单片放置不被划伤。对于中空玻璃配对时可精准取放,达到节约人力、时间及场地的目的。该架子具有玻璃固定装置,避免玻璃在推行过程当中滑落,结构采用分体式,方便拆卸安装,可极大降低运输成本。

This product is widely used in high-end glass, hollow glass pairing, and other places with a strict requirement on glass placing. It can ensure that single piece of glass not hurt when placing. For hollow glass pairing, it can take and put glass accurately, to achieve the goal of saving manpower & time & space. The shelf has a device for fixing glass to avoid glass slide down when moving. It uses separated structure, easy to disassembly and installation, can greatly reduce the cost of transportation.

技术参数/Technical Parameters

型号 Model	RSY-JPJZ-84
外观尺寸 Overall Appearance Size	1500*1800*1200 (mm)
架子重量 Weight	230kg
放置玻璃数量 Number of glass	84 pcs
玻璃厚度 Glass thickness	8mm
承载重量 Capacity	1.5T

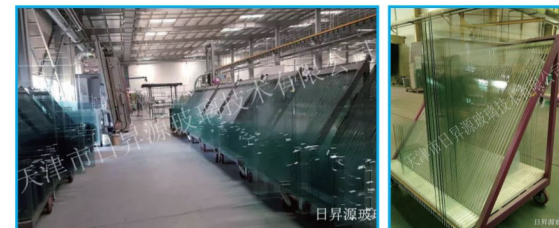

AL型玻璃原片放置架 AL-Type Sheet Glass Stock Shelf



可摆放数十包规格相同的原片玻璃,码放规范整齐,节约场地。
For same sizes of glass,this rack can storage dozens of packages to save space.

A字架 A Shape Shelf



仓储A架

A字架分为仓储架和运输架两种。
仓储A架:对于放置不同规格版面的玻璃,较为适用。该A架通过专业设计,角度合理,在使用过程中,即使只剩下单侧玻璃,也能安全放置。如需放置更多,可加装底部延伸接头,便可达到放置数十包玻璃的要求。
运输A架:采用国标材料,工业级二保焊机三次熔透焊接。在关键受力点,加装钢板焊接,满足长途运输的安全需要。
A-shape Rack including storage rack and transport rack.
Storage A shape Rack:They are suitable for storage different sizes of glass.If need to storage more packages of glass,can add extensions at the bottom of the rack.
Transport A shape Rack:This rack is made by international standard material with carbon dioxide welder.Make reinforce on some main parts for safety reasons.



移动仓储架

Removable Storage Glass Shelf Specification



优点/Advantage

适用于各型玻璃深加工企业玻璃原片的存取。
Mainly used for float glass storage in glass factory.

用途/Application

移动仓储架可以把玻璃集中管理,遥控运行,有手动、电动两种模式。取片方便,运行平稳。可帮助企业节约用地,可根据客户需求特殊定制,最大可达几十组。
Mobile storage shelves can centralized management of the glass,remote operation,manual,electric move two modes.Easy to take,smooth operation.Can help enterprises save land,but root customized according to customer needs,up to dozens of groups.



技术参数/Technical Parameters

移动仓储架规格	(1) 2440x1830型 (2) 2440x3660型 特殊尺寸可根据用户需求定制	Glass storage system Specification	(1) 2440mm*1830mm (2) 2440mm*3660mm We can custom-made special size of glass shelf according by customer requirement
最大放置玻璃尺寸	2440*3660mm	Maximun size of place the glass	2440*3660mm
玻璃架数量	10组(可根据客户需求定制)	Glass stands No.	10set

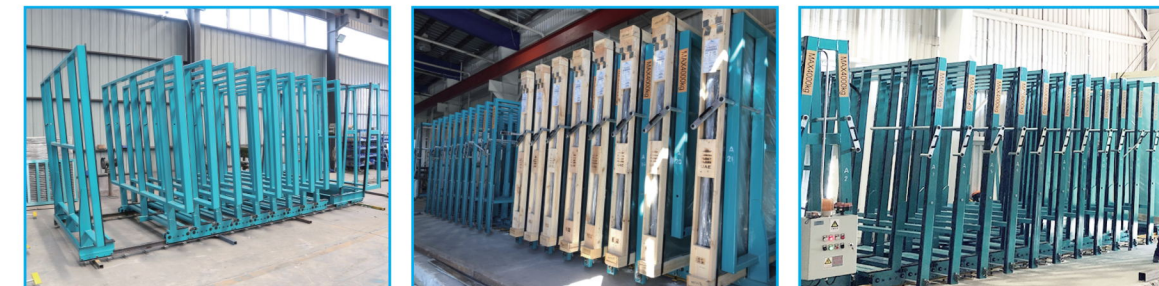

特殊定制玻璃放置架 Customized Glass Rack

我公司实力雄厚,有专业的设计团队,可根据客户构想和要求,为客户量身打造。
Our company strength is abundant,has a professional team,we can according to customer's idea and requirements, tailored for the customer.



可拆卸连体A架
Detachable conjoined A-frame



可拆卸切割机架
Removable cutting rack



车间用连体A架
One-piece A frame for workshop



集装箱海运架
Container shipping rack



可叠放L架
Stackable L-frame

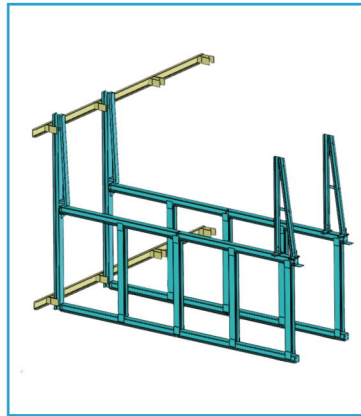

双层木箱仓储架
Double-layer wooden box storage rack



折叠移动架A
Folding mobile frame A



折叠移动架B
Folding mobile frame B

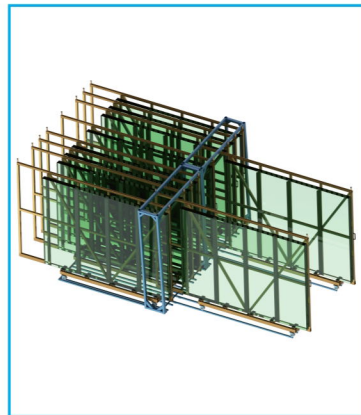

抽屉式仓储架
Drawer type storage rack

机械维修工具 Mechanical Maintenance Tool Car

此款机械车是天津日昇源公司与易尔拓工具(上海)有限公司强强联手为钢化厂设备维修完美打造的一款优化整合管理工具。易尔拓品牌源于欧洲,服务中国,产品质量上乘,在行业中有极好的口碑和赞誉。该工具车由丰富维修经验的高级资深技师根据维修需要所高度整合的一款产品,它囊括了钢化厂机器设备维修中的所有工具。优质全面的工具和双层钢化板设计的工具车有效地提升了工作效率,每个产品都有独特的模具定位,设计一目了然避免产品丢失,让您再也不用为工具的缺失而烦心。易尔拓产品全国联保,一次购买,终身质保;质量问题,终身免费更换。

This tool car is TianjinRishengyuan Glass Technology Co.,Ltd and Shanghai YATO Company building of two the centralized management tool of toughened glass factory use tools together.YATO band form Europe,Service China,good quality, excellent reputation and in the industry.The tool car maintenance by the rich experienced senior technician according to the maintenance needs of a highly integrated product that encompasses glass factory equipment maintenance of all tools.Quality comprehensive tools and design of double steel tool cart effectively enhance the workefficiency,each product has a separate mold positioning, designed to avoid product loss at a glance,so you no longer have to worry about missing the tool.One purchase,lifetime warranty and the quality and lifetime free replacement.

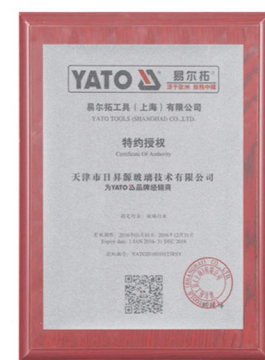
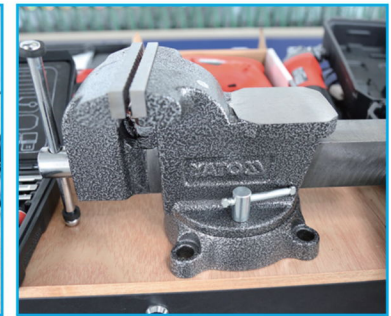

玻璃打孔工具车 Glass Drilling Tool Car

该工具向包含了玻璃打孔所需的全套工具,甚至人性化的放置了围裙、雨靴等,使你一车在手,工具不再缺失。
The toolkit contains a full set of tools,even humanized placed apron,bootsetc.and so on a makes you rest easy.

玻璃去霉套装 Glass Musty Removing Set

世界首创物理化学综合法去除玻璃起彩虹、起碱等发霉问题，产品对玻璃表面不会造成任何损伤，使用后玻璃表面焕然一新，该产品也适用于瓷砖和大理石表面的清洁。

传统的除霉方法大多使用有腐蚀和污染的强酸混合容易，操作对人体危害性大，去除效果也不理想。我公司的去霉产品均使用环保产品，操作更简便，速度更快，几秒钟轻松解决玻璃发霉问题。

First adopting physical and chemical synthetic method to remove glass rainbow, alkali and solve the mould problem. No damage to the glass surface. The glass will be as bright as a new one after cleaning. This cleaner is also suitable for cleaning tile and marble products.

Traditional method usually use solvent with causticity and strong acidity, which is harmful to people health. Our products use environment material, easy operation, fast speed, solve the problem with short time.



Glass musty removing set
玻璃去霉套装



高效去霉剂 Highly-effective Demolding Agent

该产品可有效去除玻璃表面起碱、彩虹和发霉等问题，操作非常简便，成本低廉，处理效率高！整个除霉过程仅需五秒，是目前市场上最高效产品！经过处理后的玻璃不反弹，表面焕然一新。适用于建筑、家电、电子和各种特种玻璃制品。

This product can effectively eliminate the alkaline spot, rainbow and spot on the glass surface. Its operation is very easy and its cost is very low, and the processing efficiency is very low! The entire demolding procedure only lasts for five seconds, and it is the most effective product in the market! The glass doesn't rebound after processing, and its surface acquires a completely new outlook. It is applicable in the building, home appliance, electronic products and various kinds of specialty glass products.



高效玻璃去霉剂

快速解决玻璃彩虹、发霉、起碱等问题

玻璃划痕修复工具 The Fixing Tool For The Glass Scratches

玻璃划痕修复工具修复速度快，操作简便。作为新一代的创新革命产品，我公司产品优势：第一，操作非常简便，研磨过程无需加水，简单易学；第二，修复速度快，普通的玻璃划痕熟手两三分钟即可完成修复。干磨式产品更适用于对品质要求不那么精细的建筑玻璃，操作快，解决您玻璃划痕烦恼问题，减少经济损失。

The fixing tool for glass scratches has rapid fixing speed and convenient operation. As the new generation of innovative product, the product of our company has the following advantages: the first, the operation is very convenient, and the water is not need during the grinding, and it is easy to learn; the second, the fixing is very rapid, and the common worker on glass scratch fixing can finish the fixing within two or three minutes. The dry-grinding product is more suitable for the building glass which has no elaborate requirement to the quality; the operation is rapid and it can resolve your problem of glass scratch, and reduce your economic loss.

可修复的领域包括：玻璃原片、钢化玻璃、夹胶玻璃、钢化玻璃、家具家电玻璃、幕墙门窗玻璃、汽车玻璃、工艺玻璃和手机显示屏等玻璃类产品。也适用于玻璃产品在生产、运输和安装等环境因素下产品的起碱、酸蚀、焊点和错误标识等瑕疵的去除。The fields can be fixed include: glass sheet, stalinite, laminated glass, glass for furniture and home appliance, the glass used in curtain wall, door and window, the glass for automobile, technique glass and the mobile phone screen and other glass products. It is also applicable for the flaw elimination of the products (such as alkaline spot, acid etching, welding point and wrong identification) under the environmental factors such as production, transportation and installation.



The fixing tool for the glass scratches
玻璃划痕修复工具



玻璃划痕修复套装

配件齐全 操作简单 通用性强 效果完美

企业版

- M1 2寸 研磨片 x50片
- M2 3寸 研磨片 x50片
- M3 2寸 研磨片 x50片
- M4 3寸 研磨片 x50片
- 抛光片 2寸 x 5片
- 抛光片 3寸 x 5片
- 底托 2寸 x 1个
- 底托 3寸 x 1个
- 底托 5寸 x 1个
- 海绵抛光盘 1个
- 抛光膏 250g x 4瓶
- 变速角磨机 x 1个

一次购买 终身免费指导
天津市日昇源玻璃技术有限公司



玻璃划痕修复套装

无须抛光膏 方便海外空运 操作简单 方便清理 适合施工要求高的场所

海外版

- M1 研磨片 2寸 x 10片
- M2 研磨片 2寸 x 10片
- M3 抛光片 2寸 x 10片
- 底托 2寸 x 1个
- M1 研磨片 3寸 x 25片
- M2 研磨片 3寸 x 25片
- M3 抛光片 3寸 x 25片
- 底托 3寸 x 2个
- M1 研磨片 4寸 x 15片
- M2 研磨片 4寸 x 15片
- M3 抛光片 4寸 x 15片
- 底托 4寸 x 1个

天津市日昇源玻璃技术有限公司

清胶工具
Glue Cleaning Tools



风冷型

普通型



用途/Application

该机是一款具有高效率的清胶工具，主要用于夹胶玻璃生产线中溢胶清理。现有普通型和风冷型两种，其中风冷型可持续加热，方便快捷，简单实用。

This machine is a high-efficiency cleaning tool, mainly used for cleaning glue in the laminated glass production line. There are two types of common type and air-cooled type, among which the air-cooled type can be heated continuously, which is convenient, quick, simple and practical.

技术参数/Technical Parameters

名称	风冷清胶工具	Name	Cold and windy glue tool
功率	100-250W	Power	100-250W
重量	600g	Weight	600g
输入电压	AC220V	Input voltage	AC220V
本体长度	270mm	Machine Length	270mm
刀片温度	50-500°C	Blade temperature	50-500°C



青岛鼎安达玻璃科技有限公司
Qingdao Dinganda Glass Technology Co., Ltd

公司隶属于天津市鼎安达玻璃有限公司，地处美丽的海滨城市——青岛。公司主要经营玻璃原片、玻璃深加工成品、玻璃机械和特种玻璃等产品的国际出口业务。在天津鼎安达玻璃有限公司强大后盾支持下，我们希望面向世界推广销售中国优质的玻璃和玻璃机械产品！

同时我们希望将青岛鼎安达公司打造成一家专业的进出口服务提供商，整合物流，货物报关清关，国内外贸易商资源，优化进出口渠道，凭借我公司丰富的外贸人才储备和人脉资源，立足青岛，面向世界，提供专业的进出口代理服务。

青岛鼎安达玻璃有限公司，将以优质的产品，更高的效率，更好的服务，更有竞争力的价格，给予我们的用户更好的合作体验！真诚期待与您携手合作！

The company belongs to Tianjin Dinganda Glass Co., Ltd, locates in the beautiful coastal city-Qingdao. The company's main business is exporting on float glass, deep-processed glass product, glass machinery, glass production related accessory and special glass products. With great back support of Tianjin Dinganda Glass Co., Ltd, we introduce China's high-quality glass and glass machinery products to the world! At the meantime, Qingdao Dinganda is working towards to a professional import an export service provider, integrate logistics, cargo declaration and clearance, resources of domestic and foreign traders, optimize import and export channels, relying on our company's foreign trade reserve and network resources to establish a foothold Qingdao, facing the world, provides professional import and export agency services.

Qingdao Dinganda Glass Co., Ltd will provide high-quality products, high efficiency, great service, and more competitive price to you! Sincerely look forward to working with you.



展会风采



日昇源合作伙伴

我公司拥有多名经验丰富的机械设计工程师和电气工程师，具有强大的产品设计能力和丰富的实践经验，可按照客户需求，定制非标产品。您的梦想由我们的设计团队帮您实现！

