

Specifications and dimensions are purely guideline eumeccanicashoes  
reserve the right to change specifications without prior notice,printing process  
may make the product information with a slight difference in kind, to choose  
products which are in kind.



<https://www.ezonehardware.com>



**YOUR GLASS SOLUTION**  
LEIPANG GLASS HARDWARE MANUFACTURER





## Enterprise 企业简介 Introduce

广东省肇庆市高要区利澎玻璃五金制品厂，是国内外领先的玻璃门控产品、浴室配件制造商，能够独立自主研发和生产玻璃五金配件，是集研发、生产、销售一体化的企业。

我司主营产品包括门控五金，卫浴五金等玻璃五金配件。经过37年的发展，依托雄厚的技术基础和先进的管理理念，拥有多条自动生产线，精密度高控制品质。如今拥有两个厂房和两个展厅，总面积近2万平方米多，其中80%以上的产品出口至亚洲、中东、非洲、东欧、南美和北美。

理念: Your Glass Solution, 我们提供一站式解决方案, 70%的产品由我们自己的工厂生产, 30%由我们高品质的合作伙伴生产, 严控品质要求, 使您的采购变得简单快捷。

我们期待与您建立合作关系, 实现合作双赢!

Leipang Glass hardware Products Factory, Jinli Town Gaoyao District, Zhaoqing City, Guangdong Province, is a leading manufacturer of glass door control products and bathroom accessories at home and abroad, which can independently research and develop and produce glass hardware accessories, and is an enterprise integrating research and development, production and sales.

Our main products include door control hardware, bathroom hardware and other glass hardware accessories. After 37 years of development, relying on strong technical foundation and advanced management concept, we have a number of automatic production lines, high precision and quality control. Now it has two factories and two exhibition halls with a total area of more than 20,000 square meters. More than 80% of its products are exported to Asia, the Middle East, Africa, Eastern Europe, South America and North America.

Concept :Your Glass Solution, we provide one-stop Solution, 70% of our products are produced by our own factory, 30% by our high quality partners, strict control of quality requirements, so that Your purchasing becomes simple and fast.

We look forward to cooperating with you to achieve win-win cooperation!



YOUR GLASS SOLUTION  
LEIPANG GLASS HARDWARE MANUFACTURER

# CONTENTS

## 目录

|                               |         |
|-------------------------------|---------|
| 门控套装系列·····                   | 01-05   |
| Gating Set Series             |         |
| 玻璃门夹系列·····                   | 06-27   |
| Patch Fitting Series          |         |
| 地弹簧系列·····                    | 28-48   |
| Floor Hinge Series            |         |
| 自动滑动玻璃门·····                  | 49-51   |
| Automatic Sliding Door System |         |
| 玻璃门指纹锁系列·····                 | 52-54   |
| Fingerprint Door Lock Series  |         |
| 玻璃门锁系列·····                   | 55-59   |
| Glass Door Lock Series        |         |
| 豪华拉手系列·····                   | 60-86   |
| Luxurious Handles Series      |         |
| 闭门器系列·····                    | 87-89   |
| Door Closer Series            |         |
| 静音液压合页系列·····                 | 90-91   |
| Silent Hydraulic Hinge Series |         |
| 楼梯立柱系列·····                   | 92-95   |
| Stair Handrail Series         |         |
| 护栏配件系列·····                   | 96-107  |
| Balustrade accessories Series |         |
| VI系列·····                     | 108-109 |
| VI Series                     |         |

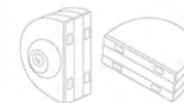
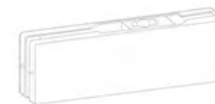



玻璃门夹系列  
GLASS DOOR CLAMP SERIES



A套装 A Set



B套装 B Set





G套装 G Set



H套装 H Set



K套装 K Set



亮光钛金  
Gold mirror



亮光玫瑰金  
Rose gold mirror



亮光银灰  
Silver grey mirror



黑色  
Black



拉丝青古铜  
Champagne

图纸说明  
INSTRUCTIONS

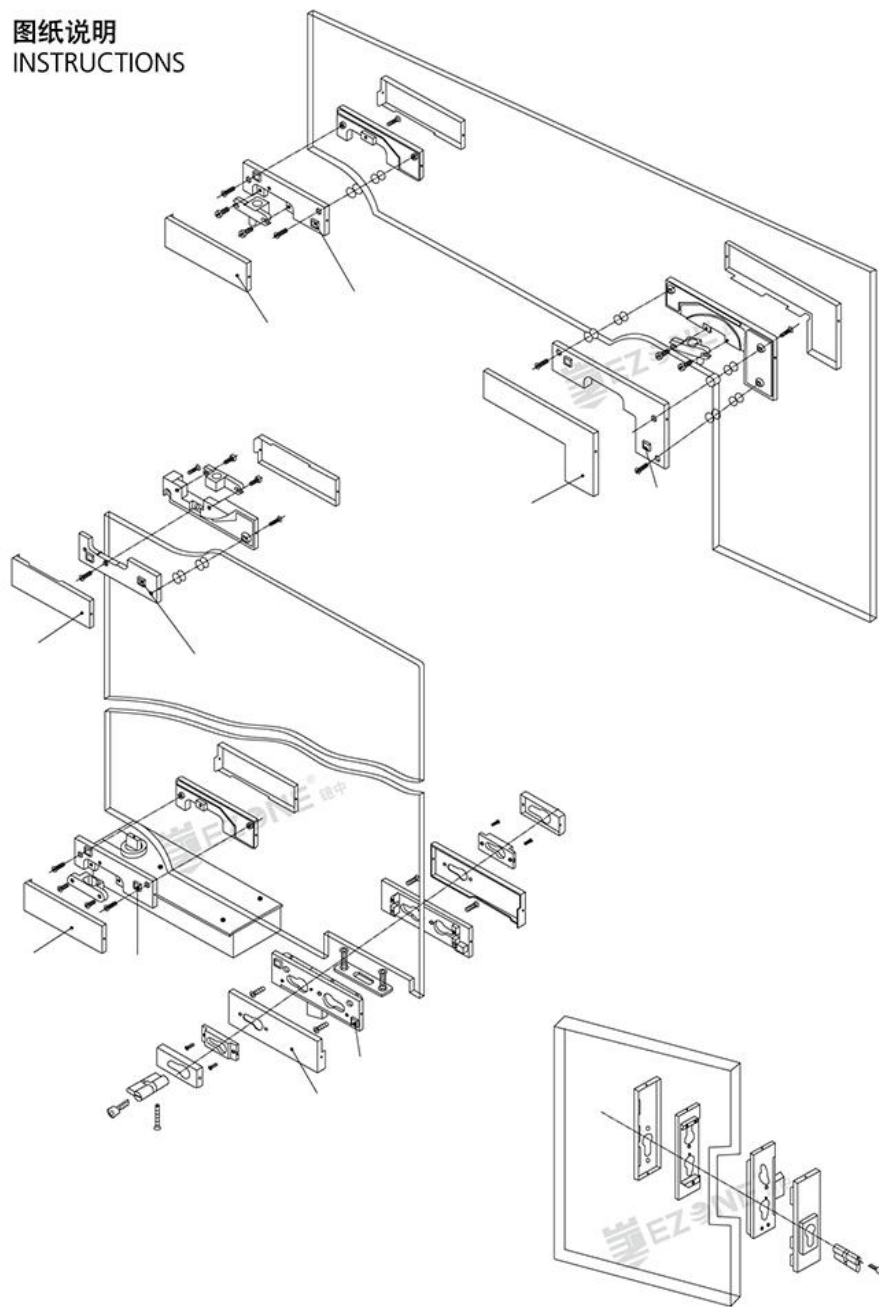

方型夹门夹安装解说图  
SQUARE PATCH FITTING MODELS

注：适用于厚度为8mm-12mm的钢化玻璃门  
Attention: suitable for 8mm-12mm tough hened glass

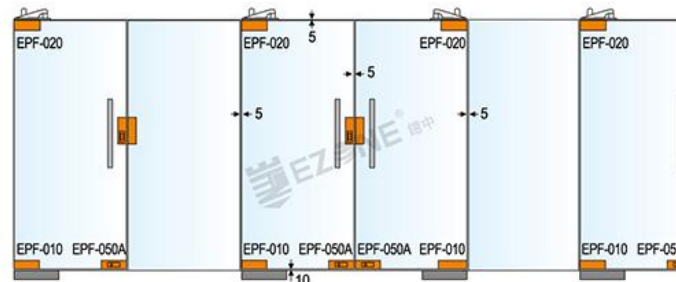

方型门夹扇式样  
Square patch fitting models

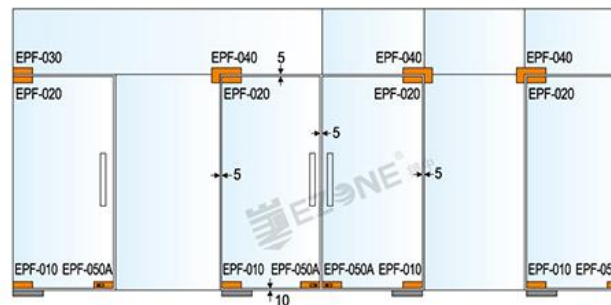
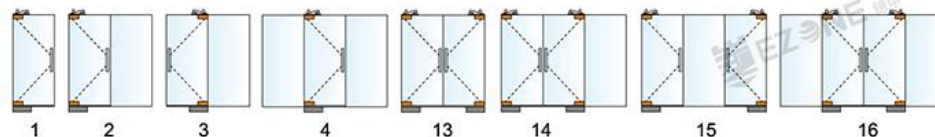

异型门夹扇式样  
Irregular patch fitting models

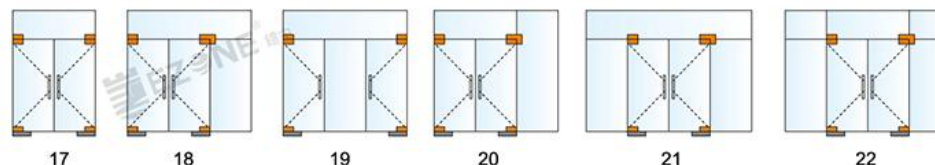
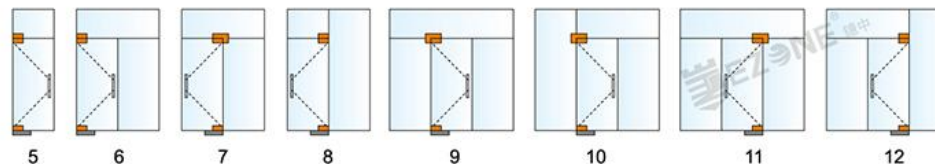



**EPF-010** 下夹 Bottom patch

1. 适用于: 10mm / 12mm玻璃
2. 材质: 铝合金、锌合金、不锈钢外壳
3. 表面处理: 砂光、亮光、钛金
4. 可与市面上流通的Dorma, New star, MBA 地弹簧配合使用

1. Fit for glass thickness: 10mm / 12mm
2. Material: Aluminum alloy / Zinc-alloy  
Stainless steel cover plate
3. Finish: Satin stainless steel(SSS)  
Polished stainless steel(PSS)  
Titanium plated(Ti)
4. Bottom patch available for Dorma, New star, MAB etc floor hinge

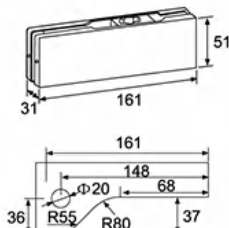

**EPF-010T** 下夹 Bottom patch

1. 适用于: 10mm / 12mm玻璃
2. 材质: 铝合金、锌合金、不锈钢外壳
3. 表面处理: 砂光、亮光、钛金
4. 可与市面上流通的Dorma, New star, MBA 地弹簧配合使用

1. Fit for glass thickness: 10mm / 12mm
2. Material: Aluminum alloy / Zinc-alloy  
Stainless steel cover plate
3. Finish: Satin stainless steel(SSS)  
Polished stainless steel(PSS)  
Titanium plated(Ti)
4. Bottom patch available for Dorma, New star, MAB etc floor hinge

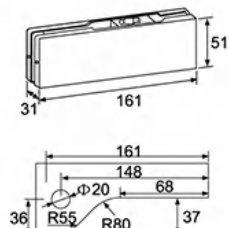

**EPF-020** 上夹 Top patch

1. 适用于: 10mm / 12mm玻璃
2. 材质: 铝合金、锌合金、不锈钢外壳
3. 表面处理: 砂光、亮光、钛金
4. 可与市面上流通的Dorma, New star, MBA 地弹簧配合使用

1. Fit for glass thickness: 10mm / 12mm
2. Material: Aluminum alloy / Zinc-alloy  
Stainless steel cover plate
3. Finish: Satin stainless steel(SSS)  
Polished stainless steel(PSS)  
Titanium plated(Ti)
4. Bottom patch available for Dorma, New star, MAB etc floor hinge

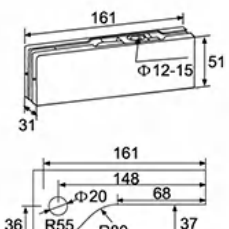

**EPF-030** 顶夹 Overpanel pivot patch

1. 适用于: 10mm / 12mm玻璃
2. 材质: 铝合金、锌合金、不锈钢外壳
3. 表面处理: 砂光、亮光、钛金
4. 可与市面上流通的Dorma, New star, MBA 地弹簧配合使用

1. Fit for glass thickness: 10mm / 12mm
2. Material: Aluminum alloy / Zinc-alloy  
Stainless steel cover plate
3. Finish: Satin stainless steel(SSS)  
Polished stainless steel(PSS)  
Titanium plated(Ti)
4. Bottom patch available for Dorma, New star, MAB etc floor hinge

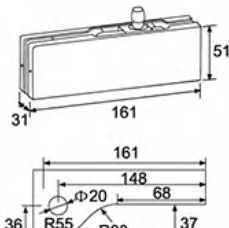

**EPF-030S** 顶夹 Overpanel pivot patch

1. 适用于: 10mm / 12mm玻璃
2. 材质: 铝合金、锌合金、不锈钢外壳
3. 表面处理: 砂光、亮光、钛金

1. Fit for glass thickness: 10mm / 12mm
2. Material: Aluminum alloy / Zinc-alloy  
Stainless steel cover plate
3. Finish: Satin stainless steel(SSS)  
Polished stainless steel(PSS)  
Titanium plated(Ti)

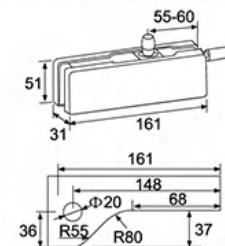

**EPF-030P** 顶夹 Overpanel pivot patch with plate

1. 适用于: 10mm / 12mm玻璃
2. 材质: 铝合金、锌合金、不锈钢外壳
3. 表面处理: 砂光、亮光、钛金

1. Fit for glass thickness: 10mm / 12mm
2. Material: Aluminum alloy / Zinc-alloy  
Stainless steel cover plate
3. Finish: Satin stainless steel(SSS)  
Polished stainless steel(PSS)  
Titanium plated(Ti)

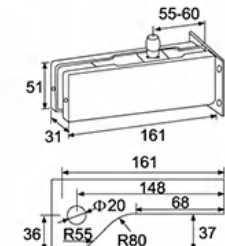

**EPF-030T** 顶夹 Overpanel pivot patch with plate

1. 适用于: 10mm / 12mm玻璃
2. 材质: 铝合金、锌合金、不锈钢外壳
3. 表面处理: 砂光、亮光、钛金

1. Fit for glass thickness: 10mm / 12mm
2. Material: Aluminum alloy / Zinc-alloy  
Stainless steel cover plate
3. Finish: Satin stainless steel(SSS)  
Polished stainless steel(PSS)  
Titanium plated(Ti)

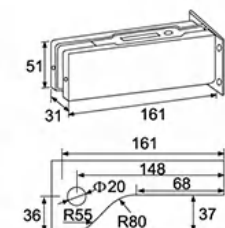

**EPF-040** 曲夹 Overpanel corner "L" patch

1. 适用于: 10mm / 12mm玻璃
2. 材质: 铝合金、锌合金、不锈钢外壳
3. 表面处理: 砂光、亮光、钛金

1. Fit for glass thickness: 10mm / 12mm
2. Material: Aluminum alloy / Zinc-alloy  
Stainless steel cover plate
3. Finish: Satin stainless steel(SSS)  
Polished stainless steel(PSS)  
Titanium plated(Ti)

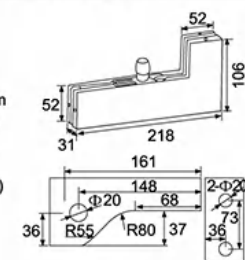



**EPF-040B** 副曲夹 Overpanel strike box "L" patch

1. 适用于: 10mm / 12mm玻璃
  2. 材质: 铝合金、锌合金、不锈钢外壳
  3. 表面处理: 砂光、亮光、钛金
  4. 应用范围: 中央门锁或地锁
1. Fit for glass thickness: 10mm / 12mm
  2. Material: Aluminum alloy / Zinc-alloy  
Stainless steel cover plate
  3. Finish: Satin stainless steel(SSS)  
Polished stainless steel(PSS)  
Titanium plated(Ti)

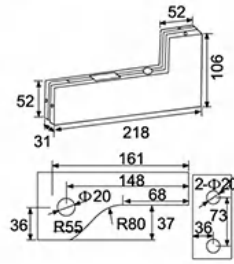

**EPF-050A** 锁夹 Patch lock

1. 适用于: 10mm / 12mm玻璃
  2. 材质: 铝合金、锌合金、不锈钢外壳
  3. 表面处理: 砂光、亮光、钛金
  4. 应用范围: 中央门锁或地锁
1. Fit for glass thickness: 10mm / 12mm
  2. Material: Aluminum alloy / Zinc-alloy  
Stainless steel cover plate
  3. Finish: Satin stainless steel(SSS)  
Polished stainless steel(PSS)  
Titanium plated(Ti)
  4. Application: Centre lock or Corner lock

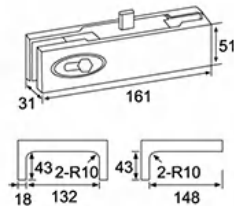

**EPF-050B** 锁夹 Patch lock

1. 适用于: 10mm / 12mm玻璃
  2. 材质: 铝合金、锌合金、不锈钢外壳
  3. 表面处理: 砂光、亮光、钛金
  4. 应用范围: 中央门锁或地锁
1. Fit for glass thickness: 10mm / 12mm
  2. Material: Aluminum alloy / Zinc-alloy  
Stainless steel cover plate
  3. Finish: Satin stainless steel(SSS)  
Polished stainless steel(PSS)  
Titanium plated(Ti)
  4. Application: Centre lock or Corner lock

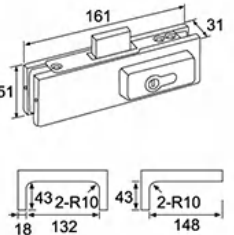

**EPF-050C** 锁夹 Patch lock

1. 适用于: 10mm / 12mm玻璃
  2. 材质: 铝合金、锌合金、不锈钢外壳
  3. 表面处理: 砂光、亮光、钛金
  4. 应用范围: 中央门锁或地锁
1. Fit for glass thickness: 10mm / 12mm
  2. Material: Aluminum alloy / Zinc-alloy  
Stainless steel cover plate
  3. Finish: Satin stainless steel(SSS)  
Polished stainless steel(PSS)  
Titanium plated(Ti)
  4. Application: Centre lock or Corner lock

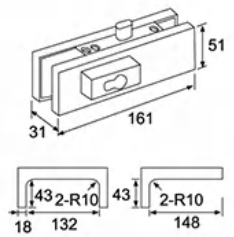

**EPF-050D** 锁夹 Patch lock

1. 适用于: 10mm / 12mm玻璃
  2. 材质: 铝合金、锌合金、不锈钢外壳
  3. 表面处理: 砂光、亮光、钛金
  4. 应用范围: 中央门锁或地锁
1. Fit for glass thickness: 10mm / 12mm
  2. Material: Aluminum alloy / Zinc-alloy  
Stainless steel cover plate
  3. Finish: Satin stainless steel(SSS)  
Polished stainless steel(PSS)  
Titanium plated(Ti)
  4. Application: Centre lock or Corner lock

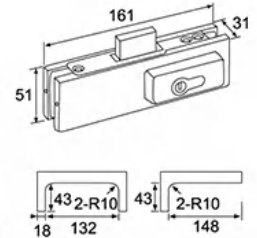

**EPF-050E** 锁夹 Patch lock

1. 适用于: 10mm / 12mm玻璃
  2. 材质: 铝合金、锌合金、不锈钢外壳
  3. 表面处理: 砂光、亮光、钛金
  4. 应用范围: 中央门锁或地锁
1. Fit for glass thickness: 10mm / 12mm
  2. Material: Aluminum alloy / Zinc-alloy  
Stainless steel cover plate
  3. Finish: Satin stainless steel(SSS)  
Polished stainless steel(PSS)  
Titanium plated(Ti)
  4. Application: Centre lock or Corner lock

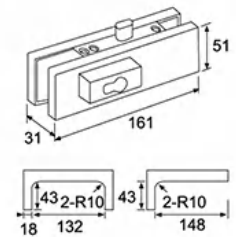

**EPF-050K** 副锁夹 Strike box

1. 适用于: 10mm / 12mm玻璃
  2. 材质: 铝合金、锌合金、不锈钢外壳
  3. 表面处理: 砂光、亮光、钛金
  4. 应用范围: 中央门锁或地锁
1. Fit for glass thickness: 10mm / 12mm
  2. Material: Aluminum alloy / Zinc-alloy  
Stainless steel cover plate
  3. Finish: Satin stainless steel(SSS)  
Polished stainless steel(PSS)  
Titanium plated(Ti)

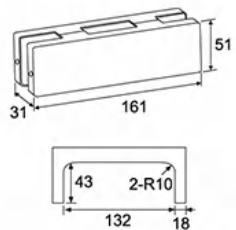

**EPF-050L** 副锁夹 Strike box

1. 适用于: 10mm / 12mm玻璃
  2. 材质: 铝合金、不锈钢外壳
  3. 表面处理: 砂光、亮光、钛金
  4. 应用范围: 中央门锁或地锁
1. Fit for glass thickness: 10mm / 12mm
  2. Material: Aluminum alloy  
Stainless steel cover plate
  3. Finish: Satin stainless steel(SSS)  
Polished stainless steel(PSS)  
Titanium plated(Ti)

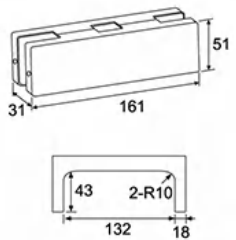



**EPF-060 半圆锁 Patch lock**

1. 适用于: 10mm / 12mm玻璃
  2. 材质: 铝合金、不锈钢外壳
  3. 表面处理: 砂光、亮光、钛金
  4. 应用范围: 中央门锁或地锁
1. Fit for glass thickness: 10mm / 12mm
  2. Material: Aluminum alloy  
Stainless steel cover plate
  3. Finish: Satin stainless steel(SSS)  
Polished stainless steel(PSS)  
Titanium plated(Ti)
  4. Application: Centre lock or Corner lock

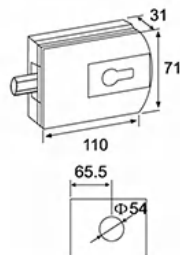

**EPF-060K 半圆副锁夹 Strike box**

1. 适用于: 10mm / 12mm玻璃
  2. 材质: 铝合金、不锈钢外壳
  3. 表面处理: 砂光、亮光、钛金
  4. 应用范围: 中央门锁或地锁
1. Fit for glass thickness: 10mm / 12mm
  2. Material: Aluminum alloy  
Stainless steel cover plate
  3. Finish: Satin stainless steel(SSS)  
Polished stainless steel(PSS)  
Titanium plated(Ti)
  4. Application: Centre lock or Corner lock

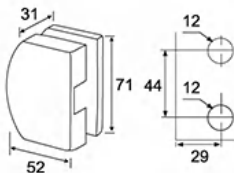

**EPF-060B 方型锁 Patch lock**

1. 适用于: 10mm / 12mm玻璃
  2. 材质: 铝合金、不锈钢外壳
  3. 表面处理: 砂光、亮光、钛金
  4. 应用范围: 中央门锁或地锁
1. Fit for glass thickness: 10mm / 12mm
  2. Material: Aluminum alloy  
Stainless steel cover plate
  3. Finish: Satin stainless steel(SSS)  
Polished stainless steel(PSS)  
Titanium plated(Ti)
  4. Application: Centre lock or Corner lock

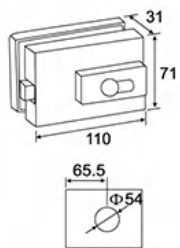

**EPF-060L 方型副锁夹 Strike box**

1. 适用于: 10mm / 12mm玻璃
  2. 材质: 铝合金、不锈钢外壳
  3. 表面处理: 砂光、亮光、钛金
  4. 应用范围: 中央门锁或地锁
1. Fit for glass thickness: 10mm / 12mm
  2. Material: Aluminum alloy  
Stainless steel cover plate
  3. Finish: Satin stainless steel(SSS)  
Polished stainless steel(PSS)  
Titanium plated(Ti)
  4. Application: Centre lock or Corner lock

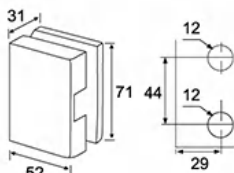

**EPF-2010 下夹 Bottom patch**

1. 适用于: 10mm玻璃
  2. 材质: 铝合金、不锈钢外壳
  3. 表面处理: 砂光、亮光、钛金
1. Fit for glass thickness: 10mm
  2. Material: Aluminum alloy  
Stainless steel cover plate
  3. Finish: Satin stainless steel(SSS)  
Polished stainless steel(PSS)  
Titanium plated(Ti)

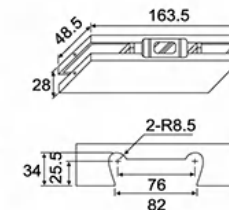

**EPF-2020 上夹 Top patch**

1. 适用于: 10mm玻璃
  2. 材质: 铝合金、不锈钢外壳
  3. 表面处理: 砂光、亮光、钛金
1. Fit for glass thickness: 10mm
  2. Material: Aluminum alloy  
Stainless steel cover plate
  3. Finish: Satin stainless steel(SSS)  
Polished stainless steel(PSS)  
Titanium plated(Ti)

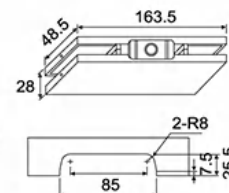

**EPF-2030 顶夹 Overpanel pivot patch**

1. 适用于: 10mm玻璃
  2. 材质: 铝合金、不锈钢外壳
  3. 表面处理: 砂光、亮光、钛金
1. Fit for glass thickness: 10mm
  2. Material: Aluminum alloy  
Stainless steel cover plate
  3. Finish: Satin stainless steel(SSS)  
Polished stainless steel(PSS)  
Titanium plated(Ti)

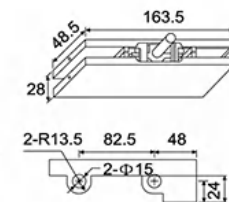

**EPF-2040P 上夹 Top patch**

1. 适用于: 10mm玻璃
  2. 材质: 铝合金、不锈钢外壳
  3. 表面处理: 砂光、亮光、钛金
1. Fit for glass thickness: 10mm
  2. Material: Aluminum alloy  
Stainless steel cover plate
  3. Finish: Satin stainless steel(SSS)  
Polished stainless steel(PSS)  
Titanium plated(Ti)

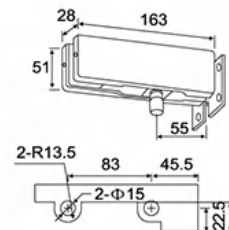



**EPF-2040 上夹 Top patch**

1. 适用于: 10mm玻璃
  2. 材质: 铝合金、不锈钢外壳
  3. 表面处理: 砂光、亮光、钛金
1. Fit for glass thickness: 10mm
  2. Material: Aluminum alloy  
Stainless steel cover plate
  3. Finish: Satin stainless steel(SSS)  
Polished stainless steel(PSS)  
Titanium plated(Ti)

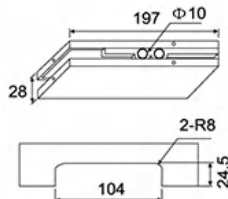

**EPF-718B 小夹 Connector for glass panel**

1. 适用于: 10mm / 12mm玻璃
  2. 材质: 铝合金、不锈钢外壳
  3. 表面处理: 砂光、亮光、钛金
1. Fit for glass thickness: 10mm / 12mm
  2. Material: Aluminum alloy  
Stainless steel cover plate
  3. Finish: Satin stainless steel(SSS)  
Polished stainless steel(PSS)  
Titanium plated(Ti)

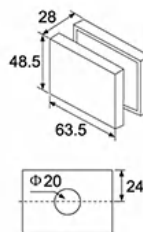

**EPF-2050 锁夹 Patch lock**

1. 适用于: 10mm玻璃
  2. 材质: 铝合金、不锈钢外壳
  3. 表面处理: 砂光、亮光、钛金
  4. 应用范围: 中央门锁或地锁
1. Fit for glass thickness: 10mm
  2. Material: Aluminum alloy  
Stainless steel cover plate
  3. Finish: Satin stainless steel(SSS)  
Polished stainless steel(PSS)  
Titanium plated(Ti)
  4. Application: Centre lock or Corner lock

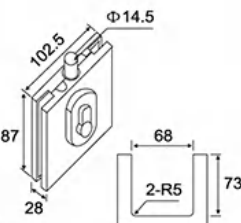

**EPF-2050A 锁夹 Patch lock**

1. 适用于: 10mm玻璃
  2. 材质: 铝合金、不锈钢外壳
  3. 表面处理: 砂光、亮光、钛金
  4. 应用范围: 中央门锁或地锁
1. Fit for glass thickness: 10mm
  2. Material: Aluminum alloy  
Stainless steel cover plate
  3. Finish: Satin stainless steel(SSS)  
Polished stainless steel(PSS)  
Titanium plated(Ti)
  4. Application: Centre lock or Corner lock

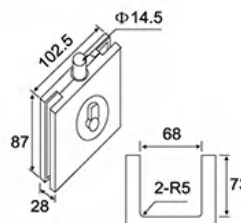

**EPF-3010 下夹 Bottom patch**

1. 适用于: 10mm / 12mm玻璃
  2. 材质: 铝合金、不锈钢外壳
  3. 表面处理: 砂光、亮光、钛金
  4. 可与市面上流通的Dorma, New star, MBA 地弹簧配合使用
1. Fit for glass thickness: 10mm / 12mm
  2. Material: Aluminum alloy  
Stainless steel cover plate
  3. Finish: Satin stainless steel(SSS)  
Polished stainless steel(PSS)  
Titanium plated(Ti)
  4. Bottom patch available for Dorma, New star, MAB etc floor hinge

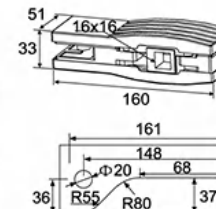

**EPF-3020 上夹 Top patch**

1. 适用于: 10mm / 12mm玻璃
  2. 材质: 铝合金、不锈钢外壳
  3. 表面处理: 砂光、亮光、钛金
  4. 可与市面上流通的Dorma, New star, MBA 地弹簧配合使用
1. Fit for glass thickness: 10mm / 12mm
  2. Material: Aluminum alloy  
Stainless steel cover plate
  3. Finish: Satin stainless steel(SSS)  
Polished stainless steel(PSS)  
Titanium plated(Ti)
  4. Bottom patch available for Dorma, New star, MAB etc floor hinge

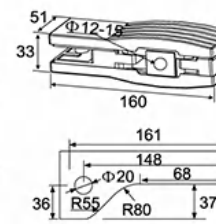

**EPF-3030S 顶夹 Overpanel pivot patch**

1. 适用于: 10mm / 12mm玻璃
  2. 材质: 铝合金、不锈钢外壳
  3. 表面处理: 砂光、亮光、钛金
1. Fit for glass thickness: 10mm / 12mm
  2. Material: Aluminum alloy  
Stainless steel cover plate
  3. Finish: Satin stainless steel(SSS)  
Polished stainless steel(PSS)  
Titanium plated(Ti)

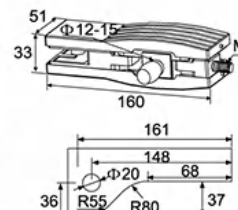

**EPF-3030P 顶夹 Overpanel pivot patch**

1. 适用于: 10mm / 12mm玻璃
  2. 材质: 铝合金、不锈钢外壳
  3. 表面处理: 砂光、亮光、钛金
1. Fit for glass thickness: 10mm / 12mm
  2. Material: Aluminum alloy  
Stainless steel cover plate
  3. Finish: Satin stainless steel(SSS)  
Polished stainless steel(PSS)  
Titanium plated(Ti)

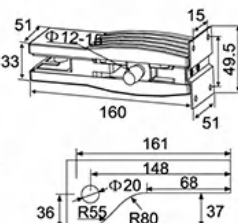



**EPF-3040** 曲夹 Overpanel corner "L" patch

1. 适用于: 10mm / 12mm玻璃
  2. 材质: 铝合金、不锈钢外壳
  3. 表面处理: 砂光、亮光、钛金
1. Fit for glass thickness: 10mm / 12mm
  2. Material: Aluminum alloy  
Stainless steel cover plate
  3. Finish: Satin stainless steel(SSS)  
Polished stainless steel(PSS)  
Titanium plated(Ti)

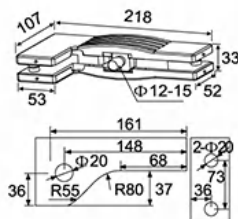

**EPF-3040B** 副曲夹 Overpanel strike box "L" patch

1. 适用于: 10mm / 12mm玻璃
  2. 材质: 铝合金、不锈钢外壳
  3. 表面处理: 砂光、亮光、钛金
1. Fit for glass thickness: 10mm / 12mm
  2. Material: Aluminum alloy  
Stainless steel cover plate
  3. Finish: Satin stainless steel(SSS)  
Polished stainless steel(PSS)  
Titanium plated(Ti)

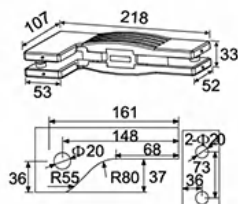

**EPF-3050** 锁夹 Patch lock

1. 适用于: 10mm / 12mm玻璃
  2. 材质: 铝合金、不锈钢外壳
  3. 表面处理: 砂光、亮光、钛金
  4. 应用范围: 中央门锁或地锁
1. Fit for glass thickness: 10mm / 12mm
  2. Material: Aluminum alloy  
Stainless steel cover plate
  3. Finish: Satin stainless steel(SSS)  
Polished stainless steel(PSS)  
Titanium plated(Ti)
  4. Application: Centre lock or Corner lock

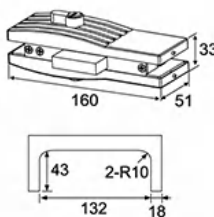

**EPF-3050B** 副锁夹 Strike box

1. 适用于: 10mm / 12mm玻璃
  2. 材质: 铝合金、不锈钢外壳
  3. 表面处理: 砂光、亮光、钛金
1. Fit for glass thickness: 10mm / 12mm
  2. Material: Aluminum alloy  
Stainless steel cover plate
  3. Finish: Satin stainless steel(SSS)  
Polished stainless steel(PSS)  
Titanium plated(Ti)

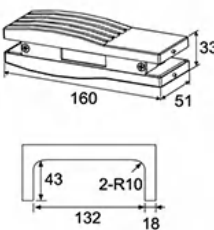

**EPF-4010** 下夹 Bottom patch

1. 适用于: 10mm / 12mm玻璃
  2. 材质: 铝合金、不锈钢外壳
  3. 表面处理: 砂光、亮光、钛金
1. Fit for glass thickness: 10mm / 12mm
  2. Material: Aluminum alloy  
Stainless steel cover plate
  3. Finish: Satin stainless steel(SSS)  
Polished stainless steel(PSS)  
Titanium plated(Ti)

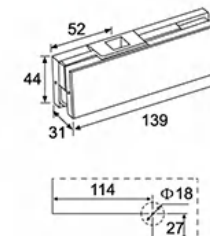

**EPF-4020** 上夹 Top patch

1. 适用于: 10mm / 12mm玻璃
  2. 材质: 铝合金、不锈钢外壳
  3. 表面处理: 砂光、亮光、钛金
1. Fit for glass thickness: 10mm / 12mm
  2. Material: Aluminum alloy  
Stainless steel cover plate
  3. Finish: Satin stainless steel(SSS)  
Polished stainless steel(PSS)  
Titanium plated(Ti)

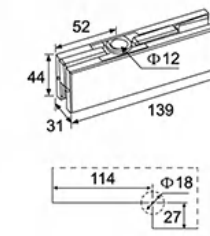

**EPF-4030P** 顶夹 Overpanel pivot patch

1. 适用于: 10mm / 12mm玻璃
  2. 材质: 铝合金、不锈钢外壳
  3. 表面处理: 砂光、亮光、钛金
1. Fit for glass thickness: 10mm / 12mm
  2. Material: Aluminum alloy  
Stainless steel cover plate
  3. Finish: Satin stainless steel(SSS)  
Polished stainless steel(PSS)  
Titanium plated(Ti)

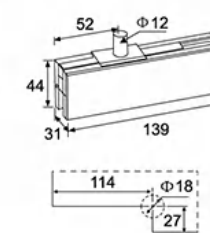

**EPF-4040** 曲夹 Overpanel corner "L" patch

1. 适用于: 10mm / 12mm玻璃
  2. 材质: 铝合金、不锈钢外壳
  3. 表面处理: 砂光、亮光、钛金
1. Fit for glass thickness: 10mm / 12mm
  2. Material: Aluminum alloy  
Stainless steel cover plate
  3. Finish: Satin stainless steel(SSS)  
Polished stainless steel(PSS)  
Titanium plated(Ti)

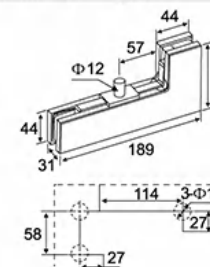



**EPF-4050&EPF-4050B 锁夹 Patch lock**

1. 适用于: 10mm / 12mm玻璃
  2. 材质: 铝合金、不锈钢外壳
  3. 表面处理: 砂光、亮光、钛金
  4. 应用范围: 中央门锁或地锁
1. Fit for glass thickness: 10mm / 12mm
  2. Material: Aluminum alloy  
Stainless steel cover plate
  3. Finish: Satin stainless steel(SSS)  
Polished stainless steel(PSS)  
Titanium plated(Ti)
  4. Application: Centre lock or Corner lock

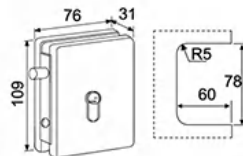

**EPF-4050A 地锁 Bottom Patch lock**

1. 适用于: 10mm / 12mm玻璃
  2. 材质: 铝合金、不锈钢外壳
  3. 表面处理: 砂光、亮光、钛金
  4. 应用范围: 中央门锁或地锁
1. Fit for glass thickness: 10mm / 12mm
  2. Material: Aluminum alloy  
Stainless steel cover plate
  3. Finish: Satin stainless steel(SSS)  
Polished stainless steel(PSS)  
Titanium plated(Ti)
  4. Application: Centre lock or Corner lock

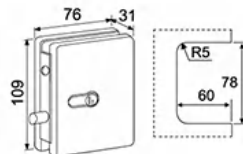

**EPF-6010 下夹 Bottom patch**

1. 适用于: 10mm / 12mm玻璃
  2. 材质: 铝合金、不锈钢外壳
  3. 表面处理: 砂光、亮光、钛金
1. Fit for glass thickness: 10mm / 12mm
  2. Material: Aluminum alloy  
Stainless steel cover plate
  3. Finish: Satin stainless steel(SSS)  
Polished stainless steel(PSS)  
Titanium plated(Ti)

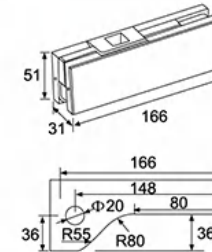

**EPF-6020 上夹 Top patch**

1. 适用于: 10mm / 12mm玻璃
  2. 材质: 铝合金、不锈钢外壳
  3. 表面处理: 砂光、亮光、钛金
1. Fit for glass thickness: 10mm / 12mm
  2. Material: Aluminum alloy  
Stainless steel cover plate
  3. Finish: Satin stainless steel(SSS)  
Polished stainless steel(PSS)  
Titanium plated(Ti)

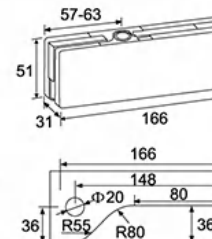

**EPF-6030 顶夹 Overpanel pivot patch**

1. 适用于: 10mm / 12mm玻璃
  2. 材质: 铝合金、不锈钢外壳
  3. 表面处理: 砂光、亮光、钛金
1. Fit for glass thickness: 10mm / 12mm
  2. Material: Aluminum alloy  
Stainless steel cover plate
  3. Finish: Satin stainless steel(SSS)  
Polished stainless steel(PSS)  
Titanium plated(Ti)

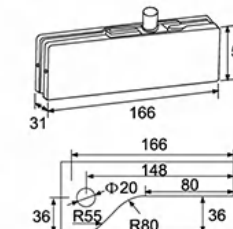

**EPF-6030P 顶夹 Overpanel pivot patch with plate**

1. 适用于: 10mm / 12mm玻璃
  2. 材质: 铝合金、不锈钢外壳
  3. 表面处理: 砂光、亮光、钛金
1. Fit for glass thickness: 10mm / 12mm
  2. Material: Aluminum alloy  
Stainless steel cover plate
  3. Finish: Satin stainless steel(SSS)  
Polished stainless steel(PSS)  
Titanium plated(Ti)

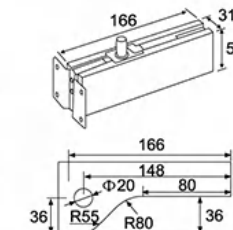



**EPF-6040** 曲夹 Overpanel corner "L" patch

1. 适用于: 10mm / 12mm玻璃
  2. 材质: 铝合金、不锈钢外壳
  3. 表面处理: 砂光、亮光、钛金
1. Fit for glass thickness: 10mm / 12mm
  2. Material: Aluminum alloy  
Stainless steel cover plate
  3. Finish: Satin stainless steel(SSS)  
Polished stainless steel(PSS)  
Titanium plated(Ti)

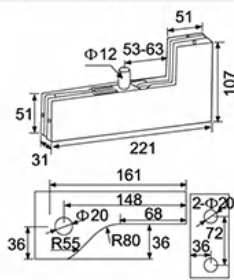

**EPF-718C** 小夹 Connector for glass panel

1. 适用于: 10mm / 12mm玻璃
  2. 材质: 铝合金、不锈钢外壳
  3. 表面处理: 砂光、亮光、钛金
1. Fit for glass thickness: 10mm / 12mm
  2. Material: Aluminum alloy  
Stainless steel cover plate
  3. Finish: Satin stainless steel(SSS)  
Polished stainless steel(PSS)  
Titanium plated(Ti)

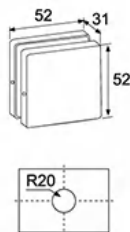

**EPF-6050** 锁夹 Patch lock

1. 适用于: 10mm / 12mm玻璃
  2. 材质: 铝合金、不锈钢外壳
  3. 表面处理: 砂光、亮光、钛金
  4. 应用范围: 中央门锁或地锁
1. Fit for glass thickness: 10mm / 12mm
  2. Material: Aluminum alloy  
Stainless steel cover plate
  3. Finish: Satin stainless steel(SSS)  
Polished stainless steel(PSS)  
Titanium plated(Ti)
  4. Application: Centre lock or Corner lock

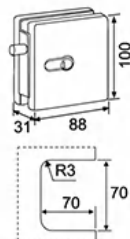

**EPF-6050B** 副锁夹 Strike box

1. 适用于: 10mm / 12mm玻璃
  2. 材质: 铝合金、不锈钢外壳
  3. 表面处理: 砂光、亮光、钛金
1. Fit for glass thickness: 10mm / 12mm
  2. Material: Aluminum alloy  
Stainless steel cover plate
  3. Finish: Satin stainless steel(SSS)  
Polished stainless steel(PSS)  
Titanium plated(Ti)

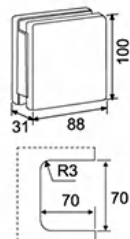

**EPF-7010** 下夹 Bottom patch

1. 适用于: 10mm / 12mm玻璃
  2. 材质: 铝合金、不锈钢外壳
  3. 表面处理: 砂光、亮光、钛金
1. Fit for glass thickness: 10mm / 12mm
  2. Material: Aluminum alloy  
Stainless steel cover plate
  3. Finish: Satin stainless steel(SSS)  
Polished stainless steel(PSS)  
Titanium plated(Ti)

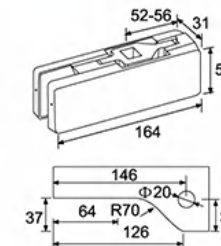

**EPF-7020** 上夹 Top patch

1. 适用于: 10mm / 12mm玻璃
  2. 材质: 铝合金、不锈钢外壳
  3. 表面处理: 砂光、亮光、钛金
1. Fit for glass thickness: 10mm / 12mm
  2. Material: Aluminum alloy  
Stainless steel cover plate
  3. Finish: Satin stainless steel(SSS)  
Polished stainless steel(PSS)  
Titanium plated(Ti)

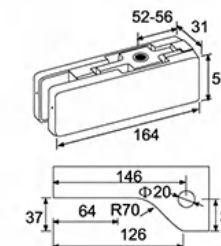

**EPF-7030** 顶夹 Overpanel pivot patch

1. 适用于: 10mm / 12mm玻璃
  2. 材质: 铝合金、不锈钢外壳
  3. 表面处理: 砂光、亮光、钛金
1. Fit for glass thickness: 10mm / 12mm
  2. Material: Aluminum alloy  
Stainless steel cover plate
  3. Finish: Satin stainless steel(SSS)  
Polished stainless steel(PSS)  
Titanium plated(Ti)

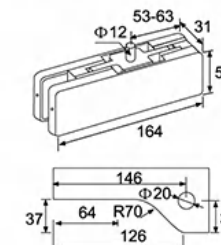

**EPF-7040** 曲夹 Overpanel corner "L" patch

1. 适用于: 10mm / 12mm玻璃
  2. 材质: 铝合金、不锈钢外壳
  3. 表面处理: 砂光、亮光、钛金
1. Fit for glass thickness: 10mm / 12mm
  2. Material: Aluminum alloy  
Stainless steel cover plate
  3. Finish: Satin stainless steel(SSS)  
Polished stainless steel(PSS)  
Titanium plated(Ti)

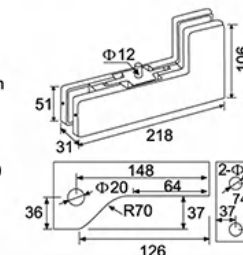



**EPF-7050 锁夹 Patch lock**

- 1. 适用于: 10mm / 12mm玻璃
- 2. 材质: 铝合金、不锈钢外壳
- 3. 表面处理: 砂光、亮光、钛金
- 1. Fit for glass thickness: 10mm / 12mm
- 2. Material: Aluminum alloy  
Stainless steel cover plate
- 3. Finish: Satin stainless steel(SSS)  
Polished stainless steel(PSS)  
Titanium plated(Ti)

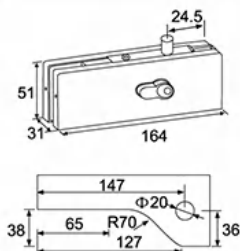

**EPF-704 异形夹 Connector patch**

- 1. 适用于: 10mm / 12mm玻璃
- 2. 材质: 精铸不锈钢
- 3. 表面处理: 砂光、亮光、钛金
- 1. Fit for glass thickness: 10mm / 12mm
- 2. Material: Casting Stainless steel
- 3. Finish: Satin stainless steel(SSS)  
Polished stainless steel(PSS)  
Titanium plated(Ti)

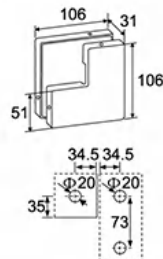

**EPF-705 七字夹 Connector patch**

- 1. 适用于: 10mm / 12mm玻璃
- 2. 材质: 精铸不锈钢
- 3. 表面处理: 砂光、亮光、钛金
- 1. Fit for glass thickness: 10mm / 12mm
- 2. Material: Casting Stainless steel
- 3. Finish: Satin stainless steel(SSS)  
Polished stainless steel(PSS)  
Titanium plated(Ti)

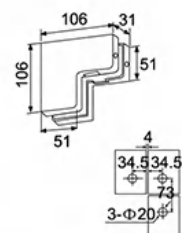

**EPF-705B 七字夹 Connector patch with stop**

- 1. 适用于: 10mm / 12mm玻璃
- 2. 材质: 精铸不锈钢
- 3. 表面处理: 砂光、亮光、钛金
- 1. Fit for glass thickness: 10mm / 12mm
- 2. Material: Casting Stainless steel
- 3. Finish: Satin stainless steel(SSS)  
Polished stainless steel(PSS)  
Titanium plated(Ti)

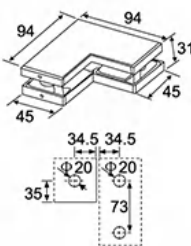

**EPF-709L 左夹 Overpanel "L" patch with fin**

- 1. 适用于: 10mm / 12mm玻璃
- 2. 材质: 铝合金、不锈钢外壳
- 3. 表面处理: 砂光、亮光、钛金
- 1. Fit for glass thickness: 10mm / 12mm
- 2. Material: Aluminum alloy  
Stainless steel cover plate
- 3. Finish: Satin stainless steel(SSS)  
Polished stainless steel(PSS)  
Titanium plated(Ti)

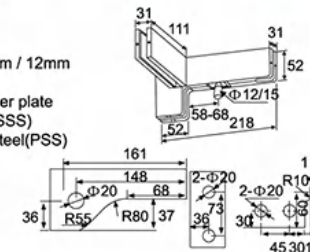

**EPF-709R 右夹 Overpanel "R" patch with fin**

- 1. 适用于: 10mm / 12mm玻璃
- 2. 材质: 铝合金、不锈钢外壳
- 3. 表面处理: 砂光、亮光、钛金
- 1. Fit for glass thickness: 10mm / 12mm
- 2. Material: Aluminum alloy  
Stainless steel cover plate
- 3. Finish: Satin stainless steel(SSS)  
Polished stainless steel(PSS)  
Titanium plated(Ti)

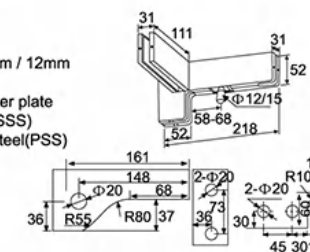

**EPF-710 T字夹 Double patch with fin T**

- 1. 适用于: 10mm / 12mm玻璃
- 2. 材质: 铝合金、不锈钢外壳
- 3. 表面处理: 砂光、亮光、钛金
- 1. Fit for glass thickness: 10mm / 12mm
- 2. Material: Aluminum alloy  
Stainless steel cover plate
- 3. Finish: Satin stainless steel(SSS)  
Polished stainless steel(PSS)  
Titanium plated(Ti)

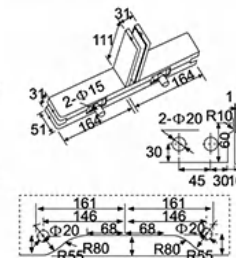

**EPF-719 异形夹 Overpanel connector with stop**

- 1. 适用于: 10mm / 12mm玻璃
- 2. 材质: 铝合金、不锈钢外壳
- 3. 表面处理: 砂光、亮光、钛金
- 1. Fit for glass thickness: 10mm / 12mm
- 2. Material: Aluminum alloy  
Stainless steel cover plate
- 3. Finish: Satin stainless steel(SSS)  
Polished stainless steel(PSS)  
Titanium plated(Ti)

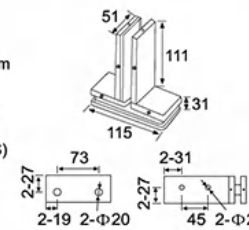



**EPF-720 异形夹** Connector for 4 glass panels with fin

1. 适用于: 10mm / 12mm玻璃
  2. 材质: 铝合金、不锈钢外壳
  3. 表面处理: 砂光、亮光、钛金
1. Fit for glass thickness: 10mm / 12mm
  2. Material: Aluminum alloy  
Stainless steel cover plate
  3. Finish: Satin stainless steel(SSS)  
Polished stainless steel(PSS)  
Titanium plated(Ti)

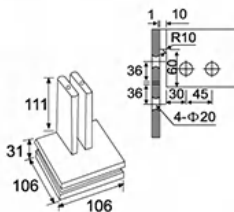

**EPF-713 四方夹** Connector for 4 glass panels

1. 适用于: 10mm / 12mm玻璃
  2. 材质: 铝合金、不锈钢外壳
  3. 表面处理: 砂光、亮光、钛金
1. Fit for glass thickness: 10mm / 12mm
  2. Material: Aluminum alloy  
Stainless steel cover plate
  3. Finish: Satin stainless steel(SSS)  
Polished stainless steel(PSS)  
Titanium plated(Ti)

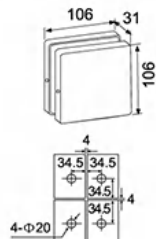

**EPF-715 小夹** Connector for glass panel

1. 适用于: 10mm / 12mm玻璃
  2. 材质: 铝合金、不锈钢外壳
  3. 表面处理: 砂光、亮光、钛金
1. Fit for glass thickness: 10mm / 12mm
  2. Material: Aluminum alloy  
Stainless steel cover plate
  3. Finish: Satin stainless steel(SSS)  
Polished stainless steel(PSS)  
Titanium plated(Ti)

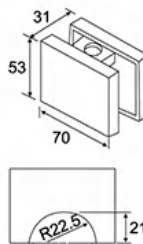

**EPF-716 一字夹** Connector for 2 glass panels with screw

1. 适用于: 10mm / 12mm玻璃
  2. 材质: 铝合金、不锈钢外壳
  3. 表面处理: 砂光、亮光、钛金
1. Fit for glass thickness: 10mm / 12mm
  2. Material: Aluminum alloy  
Stainless steel cover plate
  3. Finish: Satin stainless steel(SSS)  
Polished stainless steel(PSS)  
Titanium plated(Ti)

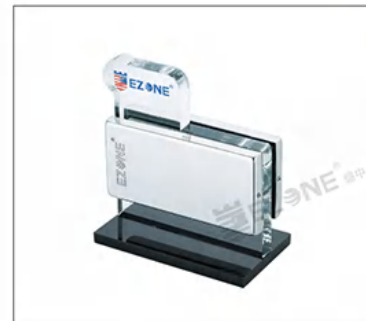
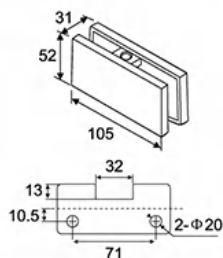

**EPF-716A 一字夹** Connector for 2 glass

1. 适用于: 10mm / 12mm玻璃
  2. 材质: 铝合金、不锈钢外壳
  3. 表面处理: 砂光、亮光、钛金
1. Fit for glass thickness: 10mm / 12mm
  2. Material: Aluminum alloy  
Stainless steel cover plate
  3. Finish: Satin stainless steel(SSS)  
Polished stainless steel(PSS)  
Titanium plated(Ti)

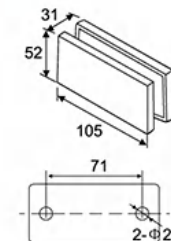

**EPF-716B 一字夹** Connector for 2 glass

1. 适用于: 10mm / 12mm玻璃
  2. 材质: 铝合金、不锈钢外壳
  3. 表面处理: 砂光、亮光、钛金
1. Fit for glass thickness: 10mm / 12mm
  2. Material: Aluminum alloy  
Stainless steel cover plate
  3. Finish: Satin stainless steel(SSS)  
Polished stainless steel(PSS)  
Titanium plated(Ti)

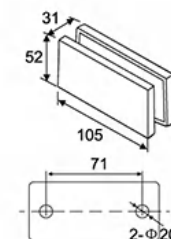

**EPF-640 小夹** Connector for glass panel

1. 适用于: 10mm / 12mm玻璃
  2. 材质: 铝合金、不锈钢外壳
  3. 表面处理: 砂光、亮光、钛金
1. Fit for glass thickness: 10mm / 12mm
  2. Material: Aluminum alloy  
Stainless steel cover plate
  3. Finish: Satin stainless steel(SSS)  
Polished stainless steel(PSS)  
Titanium plated(Ti)

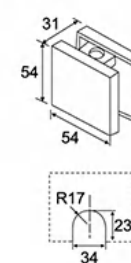

**EPF-717 小锁** Turn knob lock

1. 适用于: 10mm / 12mm玻璃
  2. 材质: 铝合金、不锈钢外壳
  3. 表面处理: 砂光、亮光、钛金
1. Fit for glass thickness: 10mm / 12mm
  2. Material: Aluminum alloy  
Stainless steel cover plate
  3. Finish: Satin stainless steel(SSS)  
Polished stainless steel(PSS)  
Titanium plated(Ti)

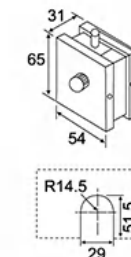



**EPF-8010**

1. 适用于: 10mm / 12mm玻璃
  2. 材质: 不锈钢
  3. 表面处理: 砂光、亮光、钛金
1. Fit for glass thickness: 10mm / 12mm
  2. Material: Stainless steel
  3. Finish: Satin Nickel  
Chrome Plated

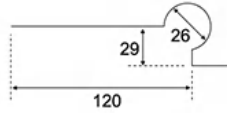

**EPF-8020**

1. 适用于: 10mm / 12mm玻璃
  2. 材质: 不锈钢
  3. 表面处理: 砂光、亮光、钛金
1. Fit for glass thickness: 10mm / 12mm
  2. Material: Stainless steel
  3. Finish: Satin Nickel  
Chrome Plated

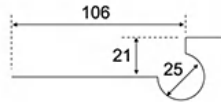

**EPF-8030** 小锁 Turn knob lock

1. 适用于: 10mm / 12mm玻璃
  2. 材质: 不锈钢
  3. 表面处理: 砂光、亮光、钛金
1. Fit for glass thickness: 10mm / 12mm
  2. Material: Stainless steel
  3. Finish: Satin Nickel  
Chrome Plated

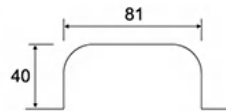

EPF-233D

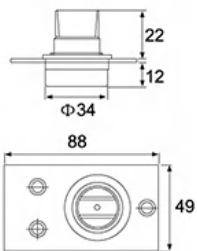

EPF-233B

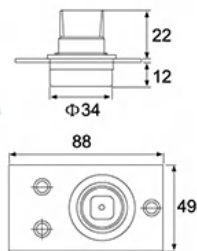

EPF-233M

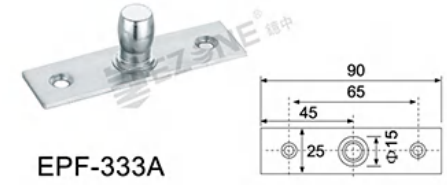

EPF-333A



EPF-333B



EPF-333C



EPF-333D

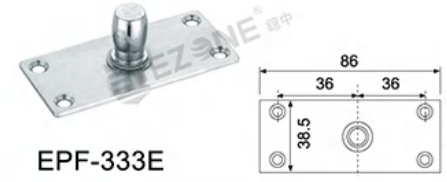

EPF-333E

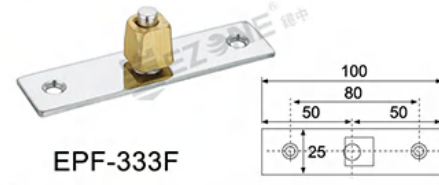

EPF-333F



EPF-333G



## 精工细造 坚固耐用

Fine workmanship strong and durable

每一台地弹簧都见证这个品牌的品质，  
坚持以客户的体验为核心，不断改变产品的使用性，  
以很好的效果回报客户，  
一台好的地弹簧，就像一块璞玉，  
需要好材料和大量的时间打磨，  
而我们的地弹簧的核心就在于“好材料”和累计的时间

Everyone floor spring bears witness to the quality of this brand. It insists on taking the customer's experience as the core, constantly changing the usability of the products, and rewarding the customers with good results. A good floor spring is like a Jade in the rough, need good material and a lot of time to Polish, and the core of our spring is "good material" and cumulative time

25°

90°

## EFS-18免挖坑

最大门重:80kg  
最大门宽:900mm  
定位角度:90°/180°/360°



EFS-18



EPF-18B



EPF-18T



产品参考尺寸  
Size:

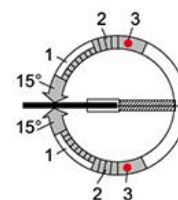
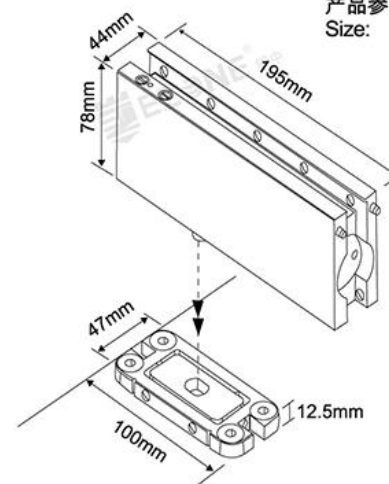

1. 闭门全程液压控制，175°-15°及15°-0° 两段独立速度调节
  2. 缓冲器功能(约于70°产生)
  3. 门扇定位设于90°或150°
1. Two-stage closing speed control valves are adjustable from 175°-15° and from 15°-0° closing process control by hydraulic oil
  2. Backcheck function(occurred in about 70 degree)
  3. Door leaf hold open function set in 90°-150°





## EFS-84

主要材质: 铸铁  
Materials: Pressed Iron  
表面处理: 拉丝、亮光  
Finish: Satin, Polished  
定位功能: 90° / 120°  
Positioning Features: 90° / 120°  
使用寿命: >70万次  
Life Cycle: >700,000 Cycles

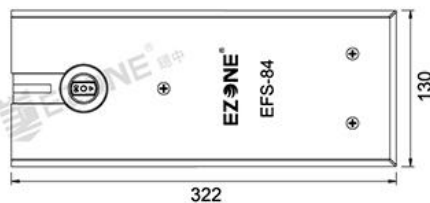
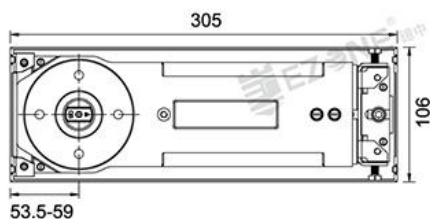

30

| 力度类别<br>Force<br>Category | 门宽<br>Door Width<br>(mm) | 承重<br>Weight<br>(kg) | 最大开启角度<br>Maximum<br>opening angle | 复位区, 缓冲区<br>Reset Area<br>Buffer Area |
|---------------------------|--------------------------|----------------------|------------------------------------|---------------------------------------|
| EN 2                      | 800                      | 80                   | 130°                               | 0°-90° 复位区<br>0°-20° 缓冲区              |
| EN 3                      | 1000                     | 100                  |                                    |                                       |
| EN 4                      | 1150                     | 120                  |                                    |                                       |

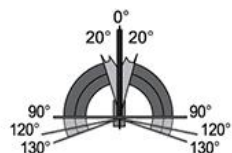

## EFS-730

主要材质: 铸铁  
Materials: Pressed Iron  
表面处理: 拉丝、亮光  
Finish: Satin, Polished  
定位功能: 90° / 120°  
Positioning Features: 90° / 120°  
使用寿命: >70万次  
Life Cycle: >700,000 Cycles

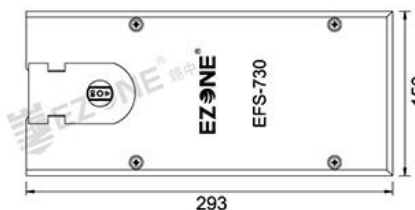
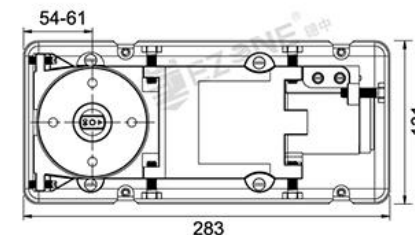

31

| 力度类别<br>Force<br>Category | 门宽<br>Door Width<br>(mm) | 承重<br>Weight<br>(kg) | 最大开启角度<br>Maximum<br>opening angle | 复位区, 缓冲区<br>Reset Area<br>Buffer Area |
|---------------------------|--------------------------|----------------------|------------------------------------|---------------------------------------|
| EN 2                      | 850                      | 80                   | 135°                               | 0°-90° 复位区<br>0°-20° 缓冲区              |
| EN 3                      | 1000                     | 100                  | 360°                               |                                       |
| EN 4                      | 1200                     | 150                  | 360°                               |                                       |

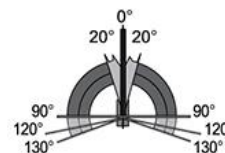



## EFS-60

主要材质: 铸铁  
Materials: Pressed Iron  
表面处理: 拉丝、亮光  
Finish: Satin, Polished  
定位功能: 90° / 120°  
Positioning Features: 90° / 120°  
使用寿命: >70万次  
Life Cycle: >700,000 Cycles

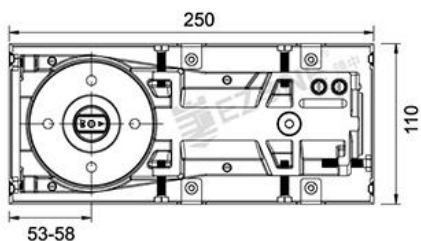

| 力度类别<br>Force Category | 门宽<br>Door Width (mm) | 承重<br>Weight (kg) | 最大开启角度<br>Maximum opening angle | 复位区, 缓冲区<br>Reset Area Buffer Area |
|------------------------|-----------------------|-------------------|---------------------------------|------------------------------------|
| EN 2                   | 800                   | 80                | 130°                            | 0°-90° 复位区                         |
| EN 3                   | 950                   | 100               |                                 | 0°-20° 缓冲区                         |

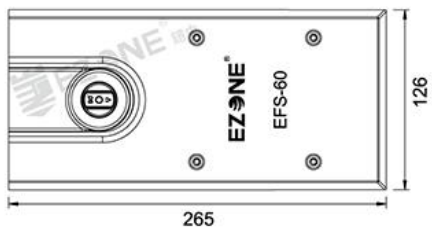
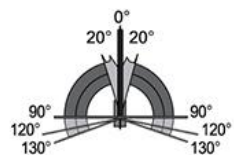

32



## EFS-65

主要材质: 铸铁  
Materials: Pressed Iron  
表面处理: 拉丝、亮光  
Finish: Satin, Polished  
定位功能: 90° / 120°  
Positioning Features: 90° / 120°  
使用寿命: >70万次  
Life Cycle: >700,000 Cycles

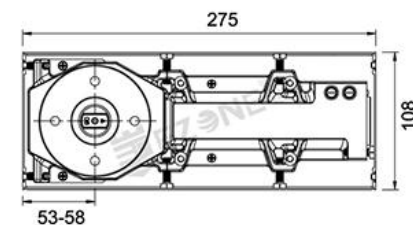

| 力度类别<br>Force Category | 门宽<br>Door Width (mm) | 承重<br>Weight (kg) | 最大开启角度<br>Maximum opening angle | 复位区, 缓冲区<br>Reset Area Buffer Area |
|------------------------|-----------------------|-------------------|---------------------------------|------------------------------------|
| EN 2                   | 800                   | 80                | 130°                            | 0°-90° 复位区                         |
| EN 3                   | 950                   | 100               |                                 | 0°-20° 缓冲区                         |

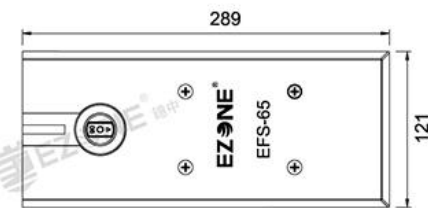
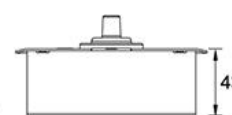
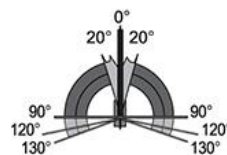

33



## EFS-75

主要材质: 铸铝/铸铁  
Materials: Pressed Aluminum/Pressed Iron  
表面处理: 拉丝、亮光  
Finish: Satin, Polished  
定位功能: 90°  
Positioning Features: 90°  
使用寿命: >70万次  
Life Cycle: >700,000 Cycles

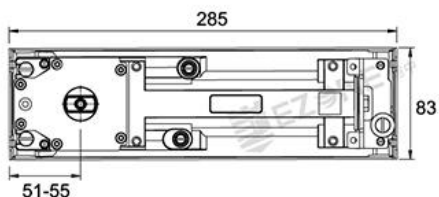

| 力度类别<br>Force Category | 门宽<br>Door Width (mm) | 承重<br>Weight (kg) | 最大开启角度<br>Maximum opening angle | 复位区, 缓冲区<br>Reset Area Buffer Area |
|------------------------|-----------------------|-------------------|---------------------------------|------------------------------------|
| (铸铝) EN 2              | 800                   | 80                | 360°                            | 0°-90° 复位区<br>0°-20° 缓冲区           |
| (铸铝) EN 3              | 950                   | 100               |                                 |                                    |
| (铸铁) EN 4              | 1150                  | 120               |                                 |                                    |

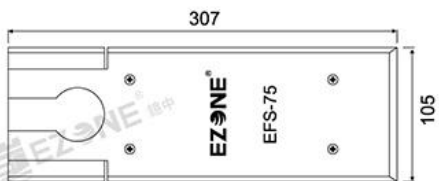
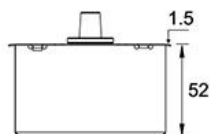
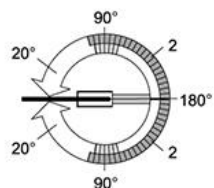

34

## EFS-86

主要材质: 铸铁  
Materials: Pressed Iron  
表面处理: 拉丝、亮光  
Finish: Satin, Polished  
定位功能: 90°  
Positioning Features: 90°  
使用寿命: >70万次  
Life Cycle: >700,000 Cycles

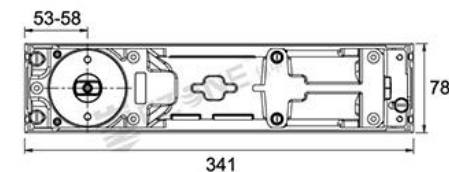

| 力度类别<br>Force Category | 门宽<br>Door Width (mm) | 承重<br>Weight (kg) | 最大开启角度<br>Maximum opening angle | 复位区, 缓冲区<br>Reset Area Buffer Area |
|------------------------|-----------------------|-------------------|---------------------------------|------------------------------------|
| EN 5                   | 1300                  | 300               | 360°                            | 0°-90° 复位区<br>0°-20° 缓冲区           |

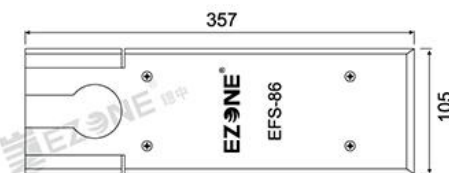
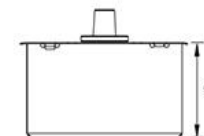
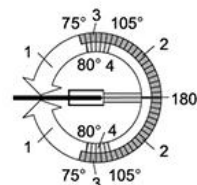

35



3mm 8mm 30mm  
可订制可换轴头

# EFS-8100

主要材质: 铸铁  
Materials: Pressed Iron  
表面处理: 拉丝、亮光  
Finish: Satin, Polished  
定位功能: 90°/180°/270°/360°  
Positioning Features: 90°/180°/270°/360°  
使用寿命: >70万次  
Life Cycle: >700,000 Cycles

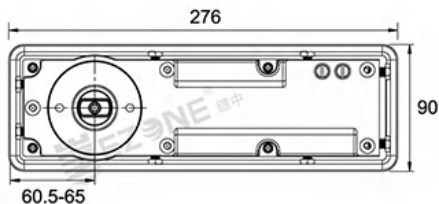

| 力度类别<br>Force Category | 门宽<br>Door Width (mm) | 承重<br>Weight (kg) | 最大开启角度<br>Maximum opening angle | 复位区, 缓冲区<br>Reset Area Buffer Area |
|------------------------|-----------------------|-------------------|---------------------------------|------------------------------------|
| EN 2                   | 800                   | 80                | 360°                            | 0°-90° 复位区<br>0°-20° 缓冲区           |
| EN 3                   | 900                   | 100               |                                 | 135°-225° 随处可停区                    |

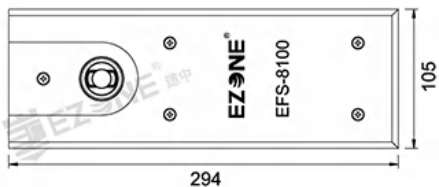
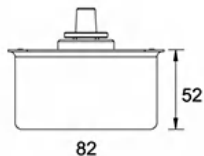
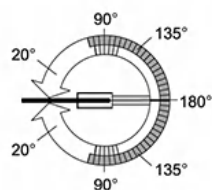

36



## EFS-205A 地弹簧 Floor hinge

| 技术参数 Technological data   |              |
|---|--------------|
| 最大门重为 Door weight   | 120kg        |
| 外观尺寸 Dimension of appearance  | 263x123x50mm |
| 适用门尺寸 Suitable for door size  | 1000x2300mm  |
| 定位角度 Location degree  | 90°          |
| 双开门 Double action door  | ✓            |
| 两段调节速度 2 Section speed adjustment valve                               | ✓            |
| 通过国家 QB/T2697-2005<br>The products have passed national QB/T2697-2005 |              |



### TRANSOM/HEADER BAR, 70mm PIVOT POINT

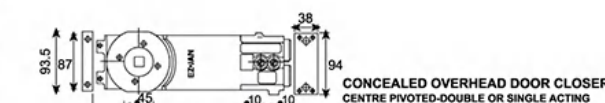
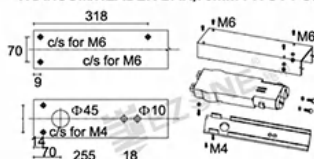

### HINGE JAMB



### PIVOT POINT (B)

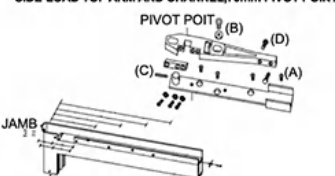

### SIDE-LOAD BOTTOM PIVOT ASSEMBLY, 70mm PIVOT POINT

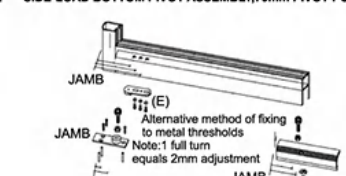

37



EFS-4500

主要材质: 铸铁  
Materials: Pressed Iron  
表面处理: 拉丝、亮光  
Finish: Satin, Polished  
定位功能: 90°  
Positioning Features: 90°  
使用寿命: >70万次  
Life Cycle: >700,000 Cycles

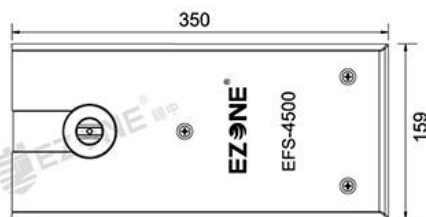
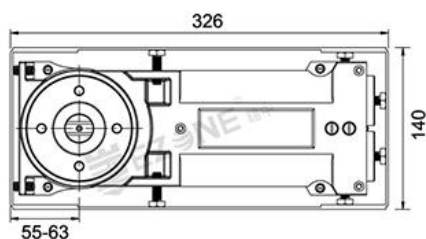

38

| 力度类别<br>Force<br>Category | 门宽<br>Door Width<br>(mm) | 承重<br>Weight<br>(kg) | 最大开启角度<br>Maximum<br>opening angle | 复位区, 缓冲区<br>Reset Area<br>Buffer Area |
|---------------------------|--------------------------|----------------------|------------------------------------|---------------------------------------|
| EN 7                      | 1500                     | 400                  | 130°                               | 0°-90° 复位区<br>0°-20° 缓冲区              |

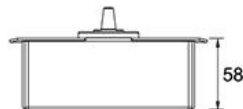
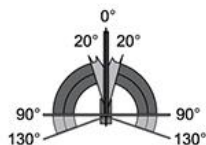

EFS-3000

主要材质: 铸铁  
Materials: Pressed Iron  
表面处理: 拉丝、亮光  
Finish: Satin, Polished  
定位功能: 90° / 120°  
Positioning Features: 90° / 120°  
使用寿命: >70万次  
Life Cycle: >700,000 Cycles

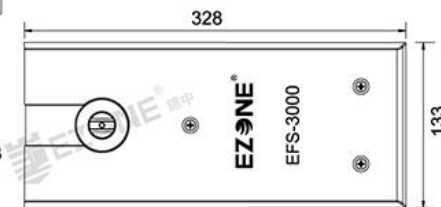
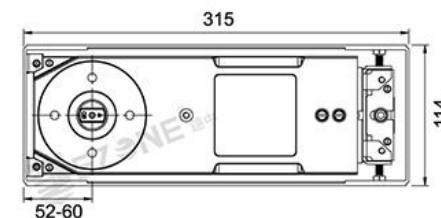

39

| 力度类别<br>Force<br>Category | 门宽<br>Door Width<br>(mm) | 承重<br>Weight<br>(kg) | 最大开启角度<br>Maximum<br>opening angle | 复位区, 缓冲区<br>Reset Area<br>Buffer Area |
|---------------------------|--------------------------|----------------------|------------------------------------|---------------------------------------|
| EN 6                      | 1400                     | 300                  | 130°                               | 0°-90° 复位区<br>0°-20° 缓冲区              |

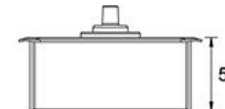
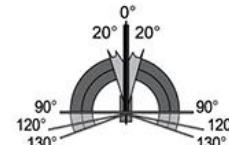



EFS-2400

主要材质: 铸铁  
Materials: Pressed Iron  
表面处理: 拉丝、亮光  
Finish: Satin, Polished  
定位功能: 90° / 120°  
Positioning Features: 90° / 120°  
使用寿命: >70万次  
Life Cycle: >700,000 Cycles

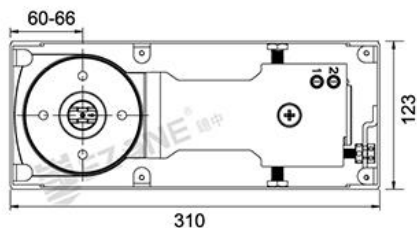

| 力度类别<br>Force Category | 门宽<br>Door Width (mm) | 承重<br>Weight (kg) | 最大开启角度<br>Maximum opening angle | 复位区, 缓冲区<br>Reset Area Buffer Area |
|------------------------|-----------------------|-------------------|---------------------------------|------------------------------------|
| EN 6                   | 1400                  | 250               | 130°                            | 0°-90° 复位区<br>0°-20° 缓冲区           |

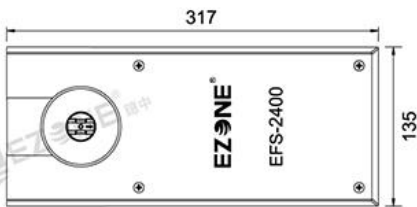
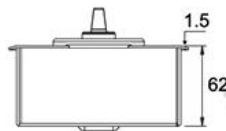
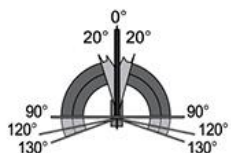

EFS-1400

主要材质: 铸铁  
Materials: Pressed Iron  
表面处理: 拉丝、亮光  
Finish: Satin, Polished  
定位功能: 90°  
Positioning Features: 90°  
使用寿命: >70万次  
Life Cycle: >700,000 Cycles

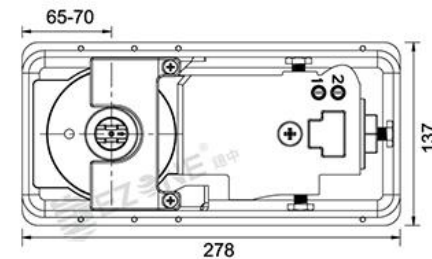

| 力度类别<br>Force Category | 门宽<br>Door Width (mm) | 承重<br>Weight (kg) | 最大开启角度<br>Maximum opening angle | 复位区, 缓冲区<br>Reset Area Buffer Area |
|------------------------|-----------------------|-------------------|---------------------------------|------------------------------------|
| EN 5                   | 1300                  | 180               | 116°                            | 0°-90° 复位区<br>0°-20° 缓冲区           |

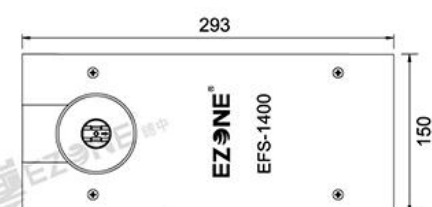
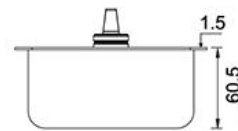
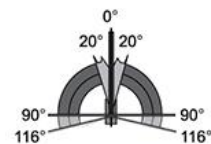



## EFS-222

主要材质: 铸铁  
Materials: Pressed Iron  
表面处理: 拉丝、亮光  
Finish: Satin, Polished  
定位功能: 90° / 120°  
Positioning Features: 90° / 120°  
使用寿命: >70万次  
Life Cycle: >700,000 Cycles

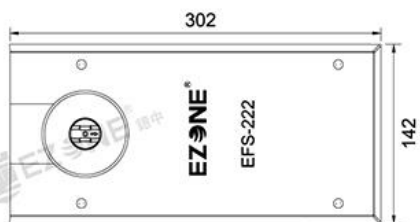
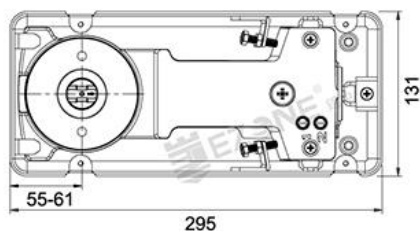

42

| 力度类别<br>Force<br>Category | 门宽<br>Door Width<br>(mm) | 承重<br>Weight<br>(kg) | 最大开启角度<br>Maximum<br>opening angle | 复位区, 缓冲<br>Reset Area<br>Buffer Area |
|---------------------------|--------------------------|----------------------|------------------------------------|--------------------------------------|
| EN 3                      | 900                      | 100                  | 130°                               | 0°-90° 复位区                           |
| EN 4                      | 1000                     | 120                  |                                    | 0°-20° 缓冲区                           |

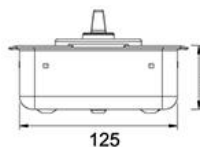
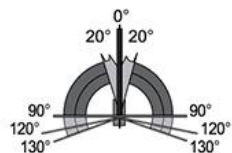

## EFS-818

主要材质: 铸铁  
Materials: Pressed Iron  
表面处理: 拉丝、亮光  
Finish: Satin, Polished  
定位功能: 90° / 120°  
Positioning Features: 90° / 120°  
使用寿命: >70万次  
Life Cycle: >700,000 Cycles

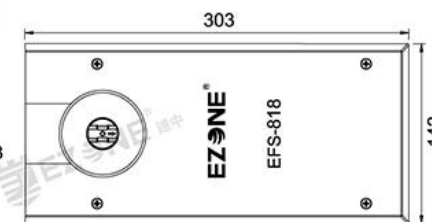
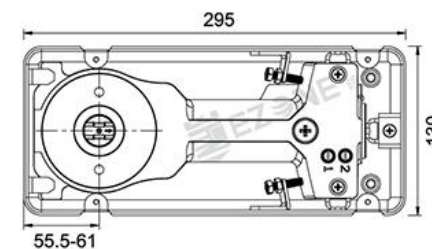

43

| 力度类别<br>Force<br>Category | 门宽<br>Door Width<br>(mm) | 承重<br>Weight<br>(kg) | 最大开启角度<br>Maximum<br>opening angle | 复位区, 缓冲<br>Reset Area<br>Buffer Area |
|---------------------------|--------------------------|----------------------|------------------------------------|--------------------------------------|
| EN 3                      | 900                      | 100                  | 130°                               | 0°-90° 复位区                           |
| EN 4                      | 1000                     | 120                  |                                    | 0°-20° 缓冲区                           |

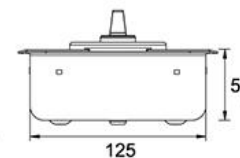
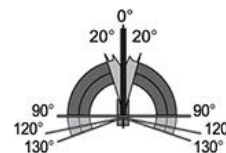



## EFS-220B

主要材质: 铸铁  
Materials: Pressed Iron  
表面处理: 拉丝、亮光  
Finish: Satin, Polished  
定位功能: 90° / 120°  
Positioning Features: 90° / 120°  
使用寿命: >70万次  
Life Cycle: >700,000 Cycles

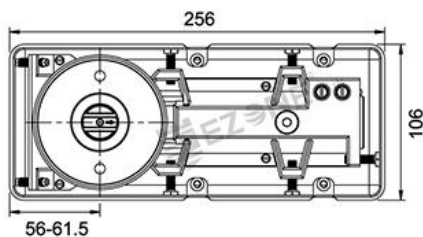

| 力度类别<br>Force<br>Category | 门宽<br>Door Width<br>(mm) | 承重<br>Weight<br>(kg) | 最大开启角度<br>Maximum<br>opening angle | 复位区, 缓冲区<br>Reset Area<br>Buffer Area |
|---------------------------|--------------------------|----------------------|------------------------------------|---------------------------------------|
| EN 2                      | 800                      | 80                   | 130°                               | 0°-90° 复位区                            |
| EN 3                      | 950                      | 100                  |                                    | 0°-20° 缓冲区                            |

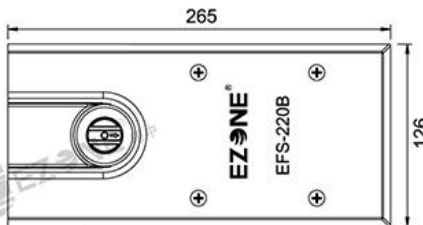
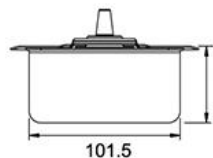
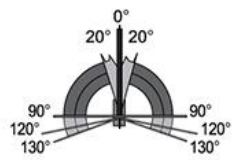

44



## EFS-50

主要材质: 铸铁  
Materials: Pressed Iron  
表面处理: 拉丝、亮光  
Finish: Satin, Polished  
定位功能: 90° / 120°  
Positioning Features: 90° / 120°  
使用寿命: >70万次  
Life Cycle: >700,000 Cycles

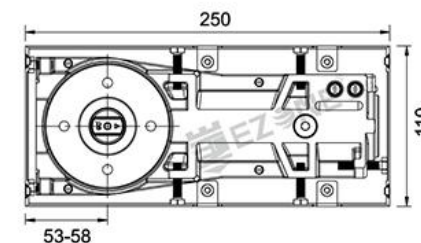

| 力度类别<br>Force<br>Category | 门宽<br>Door Width<br>(mm) | 承重<br>Weight<br>(kg) | 最大开启角度<br>Maximum<br>opening angle | 复位区, 缓冲区<br>Reset Area<br>Buffer Area |
|---------------------------|--------------------------|----------------------|------------------------------------|---------------------------------------|
| EN 2                      | 800                      | 80                   | 130°                               | 0°-90° 复位区                            |
| EN 3                      | 950                      | 100                  |                                    | 0°-20° 缓冲区                            |

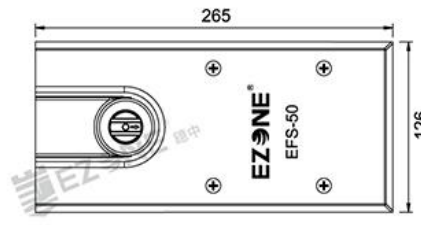
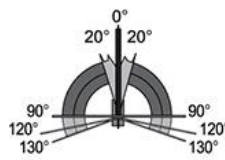

45

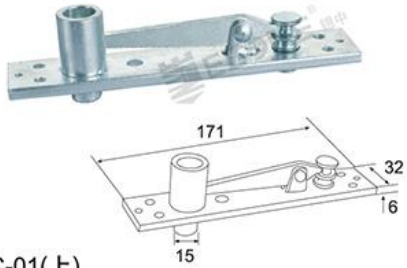

AC-01(上)  
上枢轴座: Top Pivot Seat

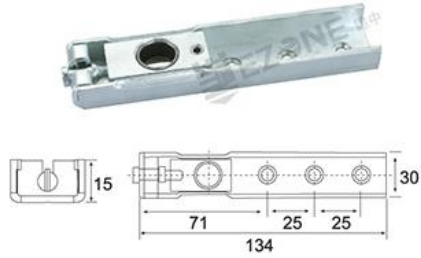

AC-01(下)  
枢轴底座: Pivot Bottom Seat

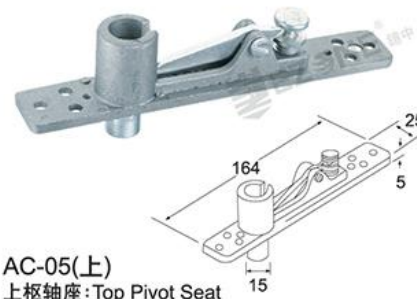

AC-05(上)  
上枢轴座: Top Pivot Seat

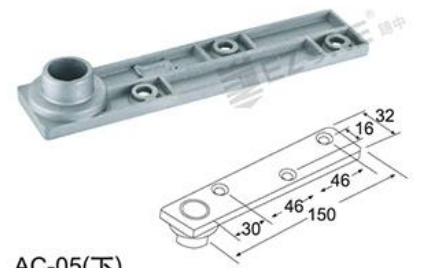

AC-05(下)  
枢轴底座: Pivot Bottom Seat

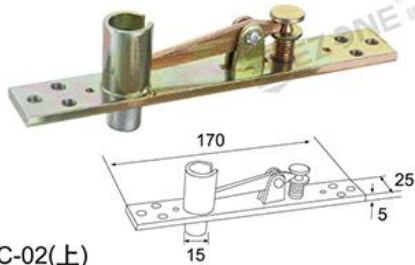

AC-02(上)  
上枢轴座: Top Pivot Seat

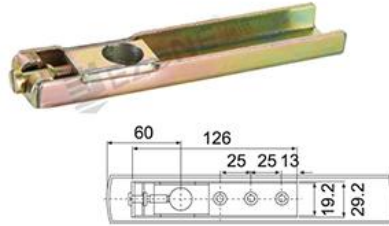

AC-02(下)  
枢轴底座: Pivot Bottom Seat

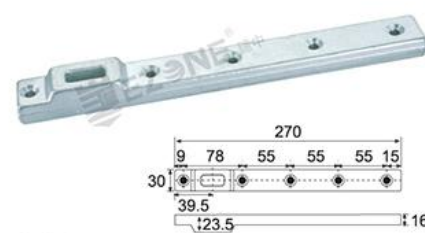

AC-06  
中心摇臂: Center Pivoted Arm

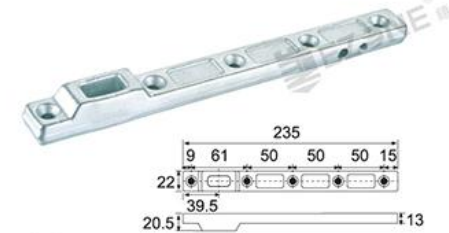

AC-07  
中心摇臂: Center Pivoted Arm

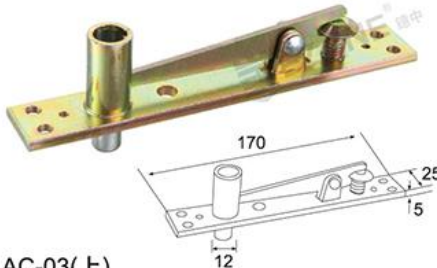

AC-03(上)  
上枢轴座: Top Pivot Seat

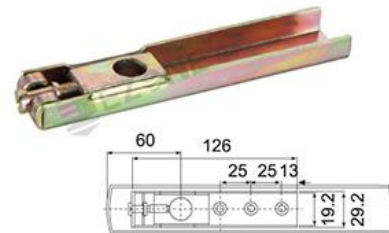

AC-03(下)  
枢轴底座: Pivot Bottom Seat



AC-11  
偏心轴  
Eccentric shaft

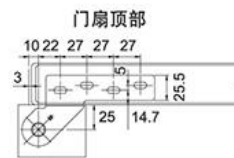

门扇顶部

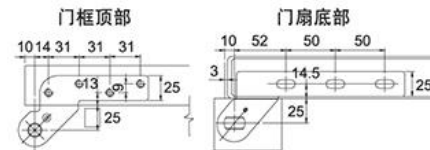

门框顶部

门扇底部

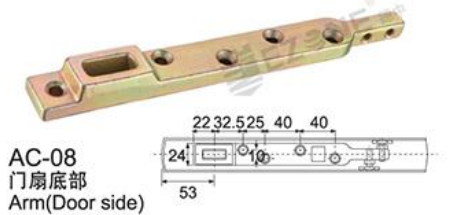

AC-08  
门扇底部  
Arm(Door side)

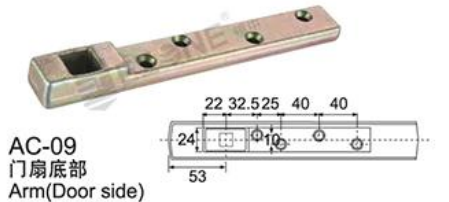

AC-09  
门扇底部  
Arm(Door side)

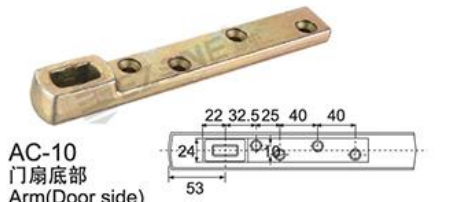

AC-10  
门扇底部  
Arm(Door side)

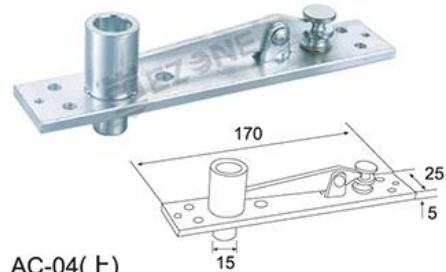

AC-04(上)  
上枢轴座: Top Pivot Seat

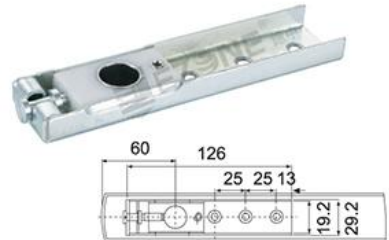

AC-04(下)  
枢轴底座: Pivot Bottom Seat

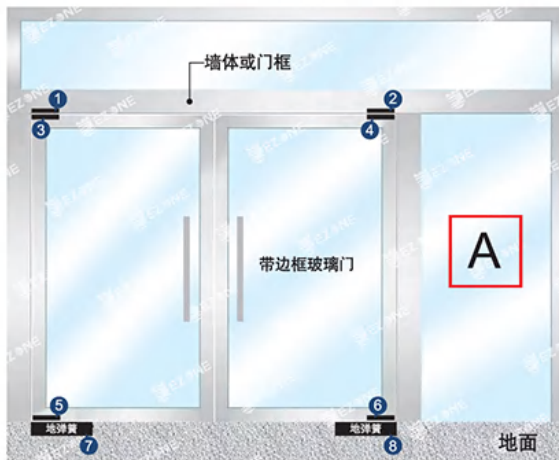

所需配件列表:

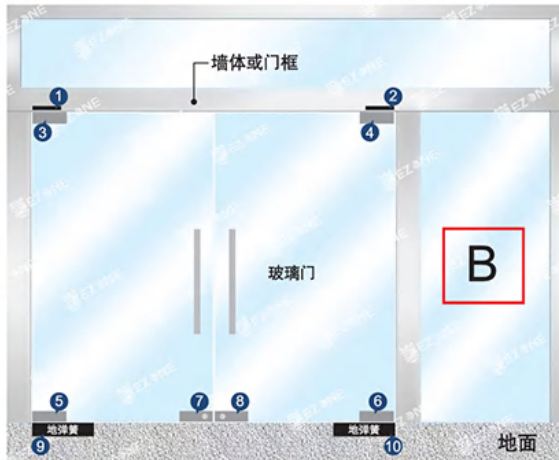

所需配件列表:

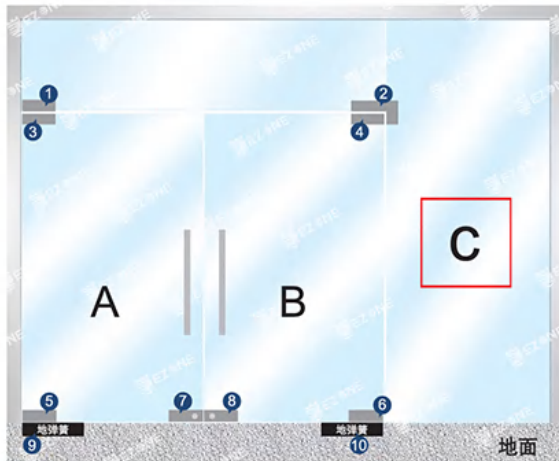

所需配件列表:



备注: 在上图中, 当A门的左侧为玻璃时, 位置①应改用曲夹。当B门的右侧为墙体或门框时, 位置②应改用顶夹。



自动滑动玻璃门  
Automatic Sliding Door System





## E-750

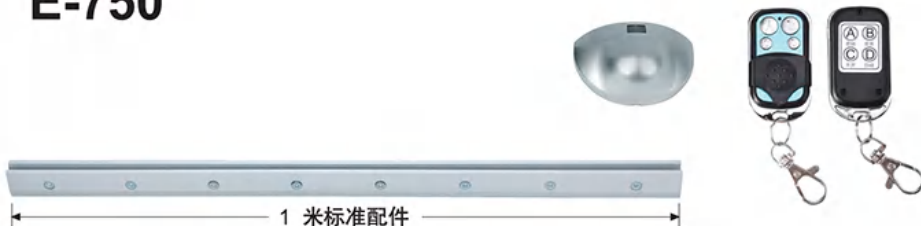

### 特性与功能

新型的重型门，采用现代化设计，应用全球信赖的大功率无刷电机及全新的机械组建，吊件（架）采用进口高强度尼龙，机组承重达2X150kg。全新设计的机组已通过多项测试。适用于各种大型通道、工业车间等场所，运行平稳，安装简便，易于维护。

### 技术参数

#### 技术参数

门体形式：单开型/对开型  
 门扇重量：< 1x200kg/ < 2x150kg  
 净开宽度：1000-2800mm / 1800-3800mm  
 电源电压：AC 220V ± 10%, 50-60Hz  
 功率消耗：<100W  
 开门运行速度：300-550mm/S(可调)  
 关门运行速度：200-500mm/S(可调)  
 开放时间：1-10S(可调)  
 紧闭力F：>100N  
 手动推力：<100N  
 运行噪音：< 55Db  
 工作环境温度：-20 ~ +50°C

### Characteristics and functions

New type heavy door, using modern design, application of global trusted high-power brushless motor and new mechanical components, hanger material is imported high strength nylon which can bear 2x150kg. The newly designed driving device has already passed multiple testing. It's suitable for all kinds of large accesses, industrial workshop and other places with smooth operation, convenient installation and easy maintenance.

### Technical data

Door configuration: single door, double-door  
 Door leaf weight: < 1x200kg / < 2x150kg  
 Clean open width: 1000-2800mm, 1800-3800mm  
 Power voltage: AC 220V ± 10%, 50-60Hz  
 AC 110V ± 10%, 50-60Hz  
 Power consumption: < 100W  
 Opening speed: 300-550mm/S (adjustable)  
 Closing speed: 200-500mm/S (adjustable)  
 Hold-open time: 1-10S(adjustable)  
 Closed force F: > 100N  
 Manual push: < 100N  
 Sliding noise: < 55Db  
 Working environment temperature: -20 ~ +50°C



## E-850 欧款加重型

### 特性与功能

新型的重型门，采用现代化设计，应用全球信赖的大功率无刷电机及全新的机械组建，吊件（架）采用进口高强度尼龙，机组承重达2X250kg。全新设计的机组已通过多项测试。适用于各种大型通道、工业车间等场所，运行平稳，安装简便，易于维护。

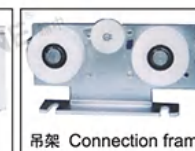
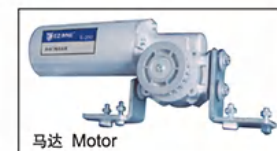
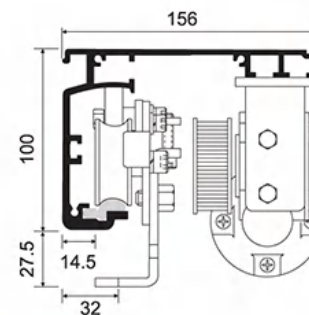

### 技术参数

门体形式：单开型/对开型  
 门扇重量：< 1x300kg/ < 2x250kg  
 净开宽度：1000-2800mm / 1800-3800mm  
 电源电压：AC 220V ± 10%, 50-60Hz  
 功率消耗：<150W  
 开门运行速度：200-460mm/S(可调)  
 关门运行速度：200-460mm/S(可调)  
 开放时间：1-10S(可调)  
 紧闭力F：>100N  
 手动推力：<100N  
 运行噪音：< 55Db  
 工作环境温度：-20 ~ +50°C

### Technical data

Door configuration: single door, double-door  
 Door leaf weight: < 1x300kg / < 2x250kg  
 Clean open width: 1000-2800mm, 1800-3800mm  
 Power voltage: AC 220V ± 10%, 50-60Hz  
 AC 110V ± 10%, 50-60Hz  
 Power consumption: < 150W  
 Opening speed: 200-460mm/S (Adjustable)  
 Closing speed: 200- 460mm/S (Adjustable)  
 Hold-open time: 1-10S(Adjustable)  
 Closed force F: > 100N  
 Manual push: < 100N  
 Sliding noise: < 55Db  
 Working environment temperature: -20 ~ +50°C

## No disassembly required Adjusting the direction

Enter the command on the lock to flip the direction

Direction Right

Direction Left



EEL-550



EEL-650



EEL-350 蓝牙指纹牛头锁(曜石黑)

TTLOCK 蓝牙锁

- TTLOCK
- 离合电机 钥匙
- APP蓝牙开锁

8大开锁方式

|        |      |      |       |
|--------|------|------|-------|
|        |      |      |       |
| 指纹解锁   | 密码解锁 | 刷卡解锁 | NFC开锁 |
|        |      |      |       |
| 微信小程序  | 钥匙开锁 | 遥控解锁 | C级锁芯  |
|        |      |      |       |
| TTLOCK | 深度防水 | 试错报警 | 低电量报警 |



EEL-450

玻璃门锁系列  
GLASS DOOR LOCK SERIES

材 质: 不锈钢  
 适合门厚: 10~12mm安全玻璃  
 表面处理: 拉丝, 亮光  
 Material: Stainless Steel  
 Suited door thickness: 10~12mm safety glass  
 Finishing: Satin, Polished

|                      |                   |
|----------------------|-------------------|
| 开锁方式<br>指纹+蓝牙+钥匙(选配) | 应用软件<br>微信小程序+APP |
| 开门方式<br>里外单独开锁       | 指纹容量<br>100枚      |
| 充电接口<br>Type-C       | 工作温度<br>-20℃~+70℃ |
| 适合门厚度<br>11-12mm     | 无框门缝<br>4-10mm    |



EFL-9012



EFL-9011

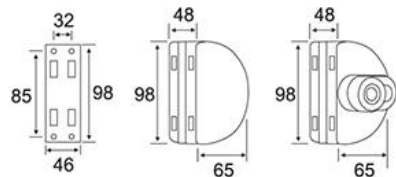

EGL-9001

- 1.适用门厚: 适用于10-18mm的钢化玻璃
  - 2.材质: 锌合金
  - 3.表面处理: 铬白, 拉丝镍, 珍珠铬
1. Fit for glass thickness: 10-18mm toughened glass  
 2. Material: Zinc alloy  
 3. Finish: Chrome, Satin nickel, Pead chrome



EGL-9002

- 1.适用门厚: 适用于10-18mm的钢化玻璃
  - 2.材质: 锌合金
  - 3.表面处理: 铬白, 拉丝镍, 珍珠铬
1. Fit for glass thickness: 10-18mm toughened glass  
 2. Material: Zinc alloy  
 3. Finish: Chrome, Satin nickel, Pead chrome



EGL-9030

- 1.适用门厚: 适用于10-18mm的钢化玻璃
  - 2.材质: 铝合金
  - 3.表面处理: 铬白, 拉丝镍, 珍珠铬
1. Fit for glass thickness: 10-18mm toughened glass  
 2. Material: Aluminum alloy  
 3. Finish: Chrome, Satin nickel, Pead chrome



EGL-9031

- 1.适用门厚: 适用于10-18mm的钢化玻璃
  - 2.材质: 铝合金
  - 3.表面处理: 铬白, 拉丝镍, 珍珠铬
1. Fit for glass thickness: 10-18mm toughened glass  
 2. Material: Aluminum alloy  
 3. Finish: Chrome, Satin nickel, Pead chrome

**EGL-9032**

- 1.适用门厚: 适用于10-18mm的钢化玻璃
- 2.材质: 锌合金
- 3.表面处理: 铬白、拉丝镍、珍珠铬

1. Fit for glass thickness: 10-18mm toughened glass
2. Material: Zinc alloy
3. Finish: Chrome, Satin nickel, Pead chrome



**EGL-9033**

- 1.适用门厚: 适用于10-18mm的钢化玻璃
- 2.材质: 锌合金
- 3.表面处理: 铬白、拉丝镍、珍珠铬

1. Fit for glass thickness: 10-18mm toughened glass
2. Material: Zinc alloy
3. Finish: Chrome, Satin nickel, Pead chrome



**EGL-9034**

- 1.适用门厚: 适用于10-18mm的钢化玻璃
- 2.材质: 锌合金
- 3.表面处理: 铬白、拉丝镍、珍珠铬

1. Fit for glass thickness: 10-18mm toughened glass
2. Material: Zinc alloy
3. Finish: Chrome, Satin nickel, Pead chrome



**EGL-9003**

- 1.适用门厚: 适用于10-18mm的钢化玻璃
- 2.材质: 锌合金、不锈钢
- 3.表面处理: 拉丝(可订做镜光、钛金等)

1. Fit for glass thickness: 10-18mm toughened glass
2. Material: Zinc alloy, Stainless steel
3. Finish: Satin(mirror, titanium etc. can be custom-made)



**EGL-9004**

- 1.适用门厚: 适用于10-18mm的钢化玻璃
- 2.材质: 锌合金、不锈钢
- 3.表面处理: 拉丝(可订做镜光、钛金等)

1. Fit for glass thickness: 10-18mm toughened glass
2. Material: Zinc alloy, Stainless steel
3. Finish: Satin(mirror, titanium etc. can be custom-made)



**EGL-9006**

- 1.适用门厚: 适用于10-18mm的钢化玻璃
- 2.材质: 锌合金、不锈钢
- 3.表面处理: 拉丝(可订做镜光、钛金等)

1. Fit for glass thickness: 10-18mm toughened glass
2. Material: Zinc alloy, Stainless steel
3. Finish: Satin(mirror, titanium etc. can be custom-made)



**EGL-9007**

- 1.适用门厚: 适用于10-18mm的钢化玻璃
- 2.材质: 不锈钢、铁
- 3.表面处理: 拉丝、亮光

1. Fit for glass thickness: 10-18mm toughened glass
2. Material: Stainless steel, Iron
3. Finish: Satin, Polished



**EGL-9008**

- 1.适用门厚: 适用于10-18mm的钢化玻璃
- 2.材质: 不锈钢、铁
- 3.表面处理: 拉丝、亮光

1. Fit for glass thickness: 10-18mm toughened glass
2. Material: Stainless steel, Iron
3. Finish: Satin, Polished



**EGL-9009**

- 1.适用门厚: 适用于10-18mm的钢化玻璃
- 2.材质: 不锈钢、铁
- 3.表面处理: 拉丝、亮光

1. Fit for glass thickness: 10-18mm toughened glass
2. Material: Stainless steel, Iron
3. Finish: Satin, Polished



**EGL-9010**

- 1.适用门厚: 适用于10-18mm的钢化玻璃
- 2.材质: 不锈钢、铁
- 3.表面处理: 拉丝、亮光

1. Fit for glass thickness: 10-18mm toughened glass
2. Material: Stainless steel, Iron
3. Finish: Satin, Polished



**EGL-9011**

- 1.适用门厚: 适用于10-18mm的钢化玻璃
- 2.材质: 不锈钢、铁
- 3.表面处理: 拉丝、亮光

1. Fit for glass thickness: 10-18mm toughened glass
2. Material: Stainless steel, Iron
3. Finish: Satin, Polished



**EGL-9012**

- 1.适用门厚: 适用于10-18mm的钢化玻璃
- 2.材质: 不锈钢、铁
- 3.表面处理: 拉丝、亮光

1. Fit for glass thickness: 10-18mm toughened glass
2. Material: Stainless steel, Iron
3. Finish: Satin, Polished



**EGL-9013**

- 1.适用门厚: 适用于10-18mm的钢化玻璃
- 2.材质: 不锈钢、铁
- 3.表面处理: 拉丝、亮光

1. Fit for glass thickness: 10-18mm toughened glass
2. Material: Stainless steel, Iron
3. Finish: Satin, Polished



**EGL-9014**

- 1.适用门厚: 适用于10-18mm的钢化玻璃
- 2.材质: 不锈钢、铁
- 3.表面处理: 拉丝、亮光

1. Fit for glass thickness: 10-18mm toughened glass
2. Material: Stainless steel, Iron
3. Finish: Satin, Polished



**EGL-9015**

- 1.适用门厚: 适用于10-18mm的钢化玻璃
- 2.材质: 不锈钢、铁
- 3.表面处理: 拉丝、亮光

1. Fit for glass thickness: 10-18mm toughened glass
2. Material: Stainless steel, Iron
3. Finish: Satin, Polished



**EGL-9016**

- 1.适用门厚: 适用于10-18mm的钢化玻璃
- 2.材质: 不锈钢、铁
- 3.表面处理: 拉丝、亮光

1. Fit for glass thickness: 10-18mm toughened glass
2. Material: Stainless steel, Iron
3. Finish: Satin, Polished



**EGL-9035**

- 1.适用门厚: 适用于10-18mm的钢化玻璃
- 2.材质: 不锈钢、铁
- 3.表面处理: 拉丝、亮光

1. Fit for glass thickness: 10-18mm toughened glass
2. Material: Stainless steel, Iron
3. Finish: Satin, Polished



**EGL-9036**

- 1.适用门厚: 适用于10-18mm的钢化玻璃
- 2.材质: 不锈钢、铁
- 3.表面处理: 拉丝、亮光

1. Fit for glass thickness: 10-18mm toughened glass
2. Material: Stainless steel, Iron
3. Finish: Satin, Polished



**EGL-9017**

- 1.适用门厚: 适用于10-18mm的钢化玻璃
- 2.材质: 不锈钢、铁
- 3.表面处理: 拉丝、亮光

1. Fit for glass thickness: 10-18mm toughened glass
2. Material: Stainless steel, Iron
3. Finish: Satin, Polished



**EGL-9018**

- 1.适用门厚: 适用于10-18mm的钢化玻璃
- 2.材质: 不锈钢、铁
- 3.表面处理: 拉丝、亮光

1. Fit for glass thickness: 10-18mm toughened glass
2. Material: Stainless steel, Iron
3. Finish: Satin, Polished

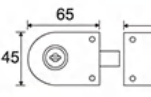
**EGL-9019**

- 1.适用门厚: 适用于10-18mm的钢化玻璃
- 2.材质: 不锈钢、铁
- 3.表面处理: 拉丝、亮光

1. Fit for glass thickness: 10-18mm toughened glass
2. Material: Stainless steel, Iron
3. Finish: Satin, Polished



**EGL-9037**

- 1.适用门厚: 适用于10-12mm的钢化玻璃
- 2.材质: 不锈钢、锌合金+ABS
- 3.表面处理: 白色+黑色

1. Fit for glass thickness: 10-12mm toughened glass
2. Material: Stainless steel, Zinc Alloy+ABS
3. Finish: White+Black



**EGL-9038**

- 1.适用门厚: 适用于10-18mm的钢化玻璃
- 2.材质: 不锈钢、铁
- 3.表面处理: 拉丝、亮光

1. Fit for glass thickness: 10-18mm toughened glass
2. Material: Stainless steel, Iron
3. Finish: Satin, Polished



**EGL-9039**

- 1.适用门厚: 适用于10-18mm的钢化玻璃
- 2.材质: 不锈钢、铁
- 3.表面处理: 拉丝、亮光

1. Fit for glass thickness: 10-18mm toughened glass
2. Material: Stainless steel, Iron
3. Finish: Satin, Polished



**EFL-9021**

- 1.材质: 铁
- 2.表面处理: 拉丝、亮光

1. Material: Iron
2. Finish: Satin, Polished



**EFL-9022**

- 1.材质: 铁
- 2.表面处理: 拉丝、亮光

1. Material: Iron
2. Finish: Satin, Polished



**EFL-9023**

- 1.材质: 铁
- 2.表面处理: 拉丝、亮光

1. Material: Iron
2. Finish: Satin, Polished



**EFL-9024**

- 1.材质: 铁
- 2.表面处理: 拉丝、亮光

1. Material: Iron
2. Finish: Satin, Polished



**EFL-9025**

- 1.材质: 铁
- 2.表面处理: 拉丝、亮光

1. Material: Iron
2. Finish: Satin, Polished



**EFL-9026**

- 1.材质: 铁
- 2.表面处理: 拉丝、亮光

1. Material: Iron
2. Finish: Satin, Polished



**EFL-9027**

- 1.材质: 铁
- 2.表面处理: 拉丝、亮光

1. Material: Iron
2. Finish: Satin, Polished



**EFL-9028**

- 1.材质: 铁
- 2.表面处理: 拉丝、亮光

1. Material: Iron
2. Finish: Satin, Polished





**EHD-853A**

材质: 不锈钢/铝合金/大理石  
表面处理: 红古铜、青古铜、钛金  
Material: Stainless steel  
Aluminum alloy / Marble  
Finish: Red bronze, Green bronze  
Titanium gold



规格/Size

| L    | C/C  | D   |
|------|------|-----|
| 800  | 500  | Φ38 |
| 1200 | 900  | Φ38 |
| 1500 | 1200 | Φ51 |
| 1800 | 1500 | Φ51 |

**EHD-854A**

材质: 不锈钢/铝合金/大理石  
表面处理: 红古铜、青古铜、钛金  
Material: Stainless steel  
Aluminum alloy / Marble  
Finish: Red bronze, Green bronze  
Titanium gold



规格/Size

| L    | C/C  | D   |
|------|------|-----|
| 800  | 500  | Φ38 |
| 1200 | 900  | Φ38 |
| 1500 | 1200 | Φ51 |
| 1800 | 1500 | Φ51 |

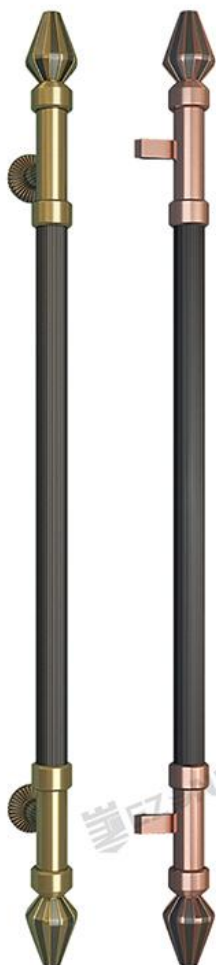

**EHD-855A**

材质: 不锈钢/铝合金  
表面处理: 红古铜、青古铜、钛金  
Material: Stainless steel  
Aluminum alloy  
Finish: Red bronze, Green bronze  
Titanium gold

规格/Size

| L    | C/C  | D   |
|------|------|-----|
| 800  | 500  | Φ38 |
| 1200 | 900  | Φ38 |
| 1500 | 1200 | Φ51 |
| 1800 | 1500 | Φ51 |

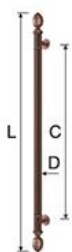

**EHD-856A**

材质: 不锈钢/铝合金  
表面处理: 红古铜、青古铜、钛金  
Material: Stainless steel  
Aluminum alloy  
Finish: Red bronze, Green bronze  
Titanium gold

规格/Size

| L    | C/C  | D   |
|------|------|-----|
| 800  | 500  | Φ38 |
| 1200 | 900  | Φ38 |
| 1500 | 1200 | Φ51 |
| 1800 | 1500 | Φ51 |

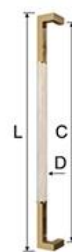

**EHD-857A**

材质: 不锈钢/大理石  
表面处理: 红古铜、青古铜、钛金  
Material: Stainless steel / Marble  
Finish: Red bronze, Green bronze  
Titanium gold

规格/Size

| L    | C/C  | D     |
|------|------|-------|
| 800  | 762  | 38x38 |
| 1200 | 1162 | 38x38 |
| 1500 | 1462 | 38x38 |
| 1800 | 1762 | 38x38 |



**EHD-858A**

材质: 不锈钢/大理石/皮革  
表面处理: 红古铜、青古铜、钛金  
Material: Stainless steel  
Marble / Leather  
Finish: Red bronze, Green bronze  
Titanium gold

规格/Size

| L    | C/C  | D     |
|------|------|-------|
| 800  | 762  | 38x38 |
| 1200 | 1162 | 38x38 |
| 1500 | 1462 | 38x38 |
| 1800 | 1762 | 38x38 |

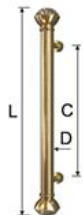
**EHD-859A**

材质: 不锈钢  
 表面处理: 红古铜、青古铜、钛金  
 Material: Stainless steel  
 Finish: Red bronze, Green bronze  
 Titanium gold

## 规格/Size

| L    | C/C  | D   |
|------|------|-----|
| 600  | 400  | Φ38 |
| 800  | 500  | Φ38 |
| 1200 | 800  | Φ38 |
| 1500 | 1100 | Φ38 |
| 1800 | 1400 | Φ38 |

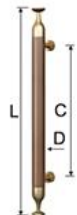
**EHD-860A**

材质: 不锈钢+木  
 表面处理: 红古铜、青古铜、钛金  
 Material: Stainless steel+Wood  
 Finish: Red bronze, Green bronze  
 Titanium gold

## 规格/Size

| L    | C/C  | D   |
|------|------|-----|
| 600  | 400  | Φ38 |
| 800  | 600  | Φ38 |
| 1000 | 800  | Φ38 |
| 1200 | 1000 | Φ38 |
| 1500 | 1300 | Φ38 |
| 1800 | 1600 | Φ38 |

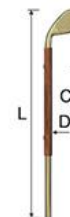
**EHD-863A**

材质: 不锈钢+木  
 表面处理: 红古铜、青古铜、钛金  
 Material: Stainless steel+Wood  
 Finish: Red bronze, Green bronze  
 Titanium gold

## 规格/Size

| L    | C/C  | D   |
|------|------|-----|
| 800  | 400  | Φ38 |
| 1000 | 500  | Φ38 |
| 1500 | 900  | Φ51 |
| 1800 | 1300 | Φ51 |

**EHD-865A**

材质: 不锈钢  
 表面处理: 红古铜、青古铜、钛金  
 Material: Stainless steel  
 Finish: Red bronze, Green bronze  
 Titanium gold

## 规格/Size

| L    | C/C  | D   |
|------|------|-----|
| 900  | 700  | Φ15 |
| 1300 | 1000 | Φ15 |
| 1800 | 1200 | Φ15 |
| 2000 | 1600 | Φ15 |

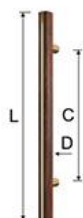
**EHD-861A**

材质: 不锈钢+木  
 表面处理: 红古铜、青古铜、钛金  
 Material: Stainless steel+Wood  
 Finish: Red bronze, Green bronze  
 Titanium gold

## 规格/Size

| L    | C/C | D   |
|------|-----|-----|
| 600  | 400 | Φ38 |
| 800  | 500 | Φ38 |
| 1200 | 800 | Φ38 |

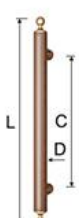
**EHD-862A**

材质: 不锈钢+木  
 表面处理: 红古铜、青古铜、钛金  
 Material: Stainless steel+Wood  
 Finish: Red bronze, Green bronze  
 Titanium gold

## 规格/Size

| L    | C/C  | D   |
|------|------|-----|
| 600  | 400  | Φ38 |
| 800  | 600  | Φ38 |
| 1000 | 800  | Φ38 |
| 1200 | 1000 | Φ38 |
| 1500 | 1300 | Φ38 |
| 1800 | 1600 | Φ38 |

**EHD-864A**

材质: 不锈钢+木  
 表面处理: 红古铜、青古铜、钛金  
 Material: Stainless steel+Wood  
 Finish: Red bronze, Green bronze  
 Titanium gold

## 规格/Size

| L    | C/C  | D   |
|------|------|-----|
| 600  | 400  | Φ38 |
| 800  | 600  | Φ38 |
| 1000 | 800  | Φ38 |
| 1200 | 1000 | Φ38 |
| 1500 | 1300 | Φ38 |
| 1800 | 1600 | Φ38 |

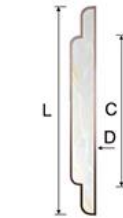
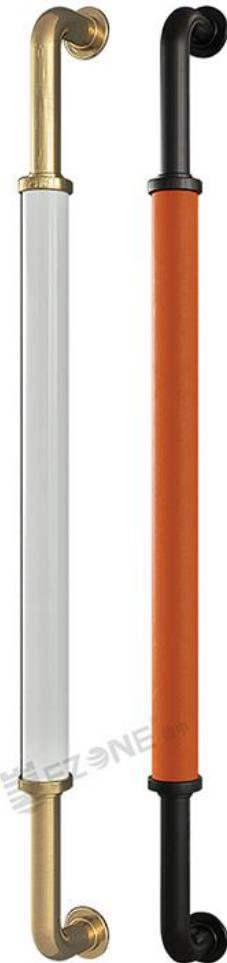
**EHD-867A**

材质: 不锈钢/大理石  
 表面处理: 红古铜、青古铜、钛金  
 Material: Stainless steel / Marble  
 Finish: Red bronze, Green bronze  
 Titanium gold

## 规格/Size

| L    | C/C | D |
|------|-----|---|
| 600  | 400 | ∕ |
| 800  | 500 | ∕ |
| 1200 | 800 | ∕ |

**EHD-868A**

材质: 不锈钢/大理石  
 表面处理: 红古铜、青古铜、钛金  
 Material: Stainless steel / Marble  
 Finish: Red bronze, Green bronze  
 Titanium gold

## 规格/Size

| L    | C/C | D |
|------|-----|---|
| 900  | ∕   | ∕ |
| 1300 | ∕   | ∕ |
| 1600 | ∕   | ∕ |
| 1800 | ∕   | ∕ |

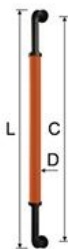
**EHD-866A**

材质: 不锈钢/大理石/皮革  
 表面处理: 红古铜、青古铜、钛金  
 Material: Stainless steel  
 Marble / Leather  
 Finish: Red bronze, Green bronze  
 Titanium gold

## 规格/Size

| L    | C/C  | D   |
|------|------|-----|
| 800  | 762  | Φ38 |
| 1200 | 1162 | Φ38 |
| 1500 | 1449 | Φ51 |
| 1800 | 1749 | Φ51 |

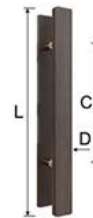
**EHD-869A**

材质: 木  
 Material: Wood

## 规格/Size

| L    | C/C  | D     |
|------|------|-------|
| 600  | 400  | 30x15 |
| 800  | 500  | 30x15 |
| 1200 | 800  | 30x15 |
| 1500 | 1100 | 30x15 |
| 1800 | 1400 | 30x15 |

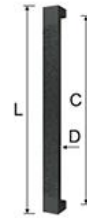
**EHD-870A**

材质: 铝合金  
 表面处理: 红古铜、青古铜、钛金  
 Material: Aluminum alloy  
 Finish: Red bronze, Green bronze  
 Titanium gold

## 规格/Size

| L    | C/C  | D     |
|------|------|-------|
| 600  | 400  | 30x15 |
| 800  | 500  | 30x15 |
| 1200 | 800  | 30x15 |
| 1500 | 1100 | 30x15 |
| 1800 | 1400 | 30x15 |

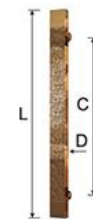
**EHD-871A**

材质: 铝合金  
 表面处理: 红古铜、青古铜、钛金  
 Material: Aluminum alloy  
 Finish: Red bronze, Green bronze  
 Titanium gold

## 规格/Size

| L    | C/C | D      |
|------|-----|--------|
| 600  | ∕   | 100x50 |
| 800  | ∕   | 100x50 |
| 1200 | ∕   | 100x50 |
| 1500 | ∕   | 100x50 |
| 1800 | ∕   | 100x50 |

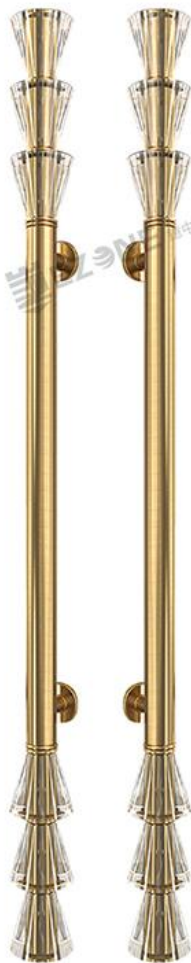

**EHD-872A**

材质: 不锈钢+水晶  
表面处理: 红古铜、青古铜、钛金  
Material: Stainless steel+Crystal  
Finish: Red bronze, Green bronze  
Titanium gold

规格/Size

| L    | C/C | D   |
|------|-----|-----|
| 800  | ∕   | Φ38 |
| 1200 | ∕   | Φ38 |
| 1500 | ∕   | Φ51 |
| 1800 | ∕   | Φ51 |



**EHD-873A**

材质: 不锈钢+水晶  
表面处理: 红古铜、青古铜、钛金  
Material: Stainless steel+Crystal  
Finish: Red bronze, Green bronze  
Titanium gold

规格/Size

| L    | C/C | D   |
|------|-----|-----|
| 800  | ∕   | Φ38 |
| 1200 | ∕   | Φ38 |
| 1500 | ∕   | Φ51 |
| 1800 | ∕   | Φ51 |

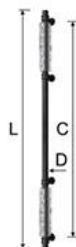

**EHD-874A**

材质: 不锈钢+水晶  
表面处理: 红古铜、青古铜、钛金  
Material: Stainless steel+Crystal  
Finish: Red bronze, Green bronze  
Titanium gold

规格/Size

| L    | C/C | D   |
|------|-----|-----|
| 600  | ∕   | Φ38 |
| 800  | ∕   | Φ38 |
| 1000 | ∕   | Φ38 |
| 1200 | ∕   | Φ38 |
| 1500 | ∕   | Φ51 |
| 1800 | ∕   | Φ51 |



EHD-875A



EHD-876A



EHD-877A



EHD-878A



EHD-879A



EHD-880A



EHD-881A



EHD-882A



EHD-883A



EHD-884A



EHD-885A



EHD-886A



**EHD-950**

材 质: 不锈钢/铝合金  
Material:Stainless steel/Aluminum alloy  
表面处理: 青古铜/红古铜/钛金/玫瑰金/拉丝/亮光  
Finish:Green Bronze/Red Bronze/Gold/Rose Gold/Drawbench/Mirror

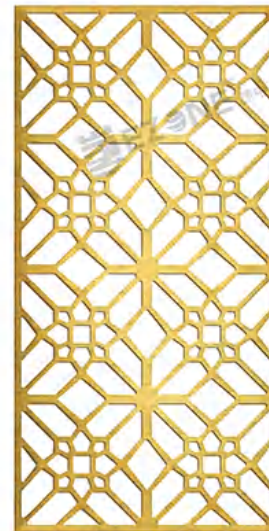

**EHD-952**

材 质: 不锈钢/铝合金  
Material:Stainless steel/Aluminum alloy



**EHD-953**

材 质: 不锈钢/铝合金  
Material:Stainless steel/Aluminum alloy



**EHD-954**

材 质: 不锈钢/铝合金  
Material:Stainless steel/Aluminum alloy

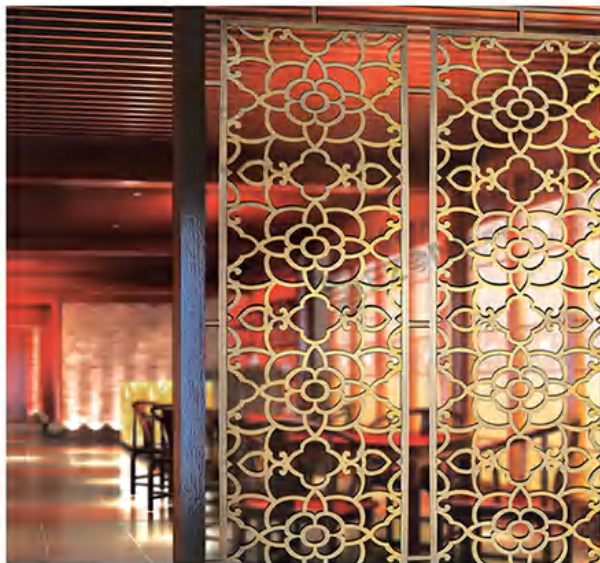

**EHD-951**

材 质: 不锈钢/铝合金  
Material:Stainless steel/Aluminum alloy  
表面处理: 青古铜/红古铜/钛金/玫瑰金/拉丝/亮光  
Finish:Green Bronze/Red Bronze/Gold/Rose Gold/Drawbench/Mirror

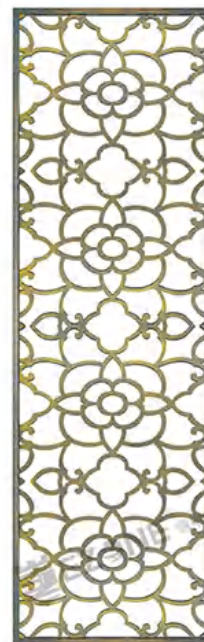

**EHD-955**

材 质: 不锈钢/铝合金  
Material:Stainless steel/Aluminum alloy



**EHD-956**

材 质: 不锈钢/铝合金  
Material:Stainless steel/Aluminum alloy



**YOUR GLASS SOLUTION**  
LEIPANG GLASS HARDWARE MANUFACTURER

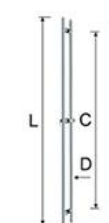
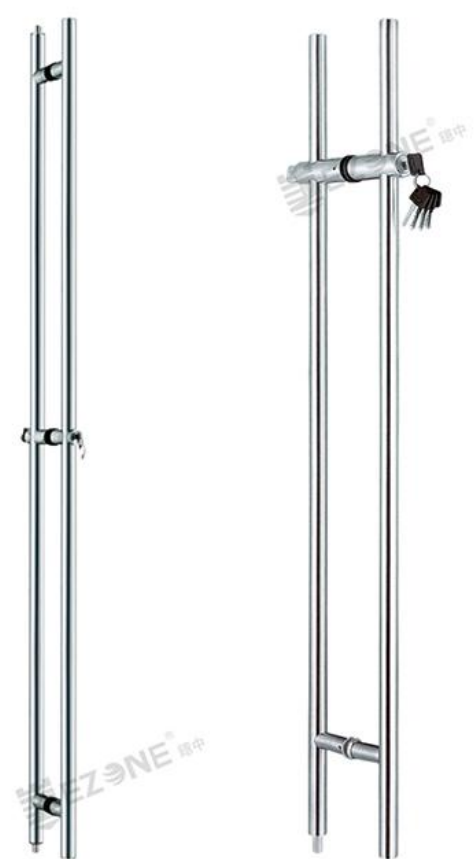

**EHD-801**

材质: 不锈钢  
表面处理: 砂光、镜光、钛金  
Material: Stainless steel  
Finish: Satin Stainless Steel (SSS)  
Polished Stainless Steel (PSS)  
Titanium Plated (Ti)

规格/Size

| L    | C/C  | D   |
|------|------|-----|
| 1500 | 1120 | Φ38 |

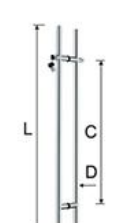
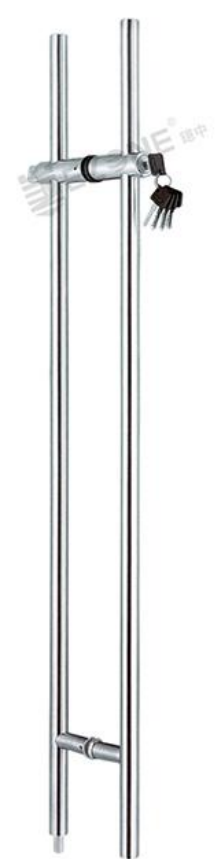

**EHD-802**

材质: 不锈钢  
表面处理: 砂光、镜光、钛金  
Material: Stainless steel  
Finish: Satin Stainless Steel (SSS)  
Polished Stainless Steel (PSS)  
Titanium Plated (Ti)

规格/Size

| L    | C/C  | D   |
|------|------|-----|
| 2000 | 1125 | Φ38 |

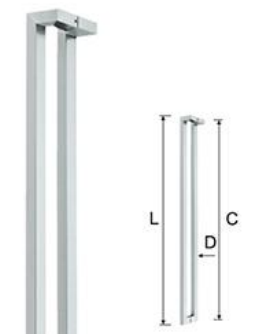

**EHD-803**

材质: 不锈钢  
表面处理: 砂光、镜光、钛金  
Material: Stainless steel  
Finish: Satin Stainless Steel (SSS)  
Polished Stainless Steel (PSS)  
Titanium Plated (Ti)

规格/Size

| L    | C/C    | D     |
|------|--------|-------|
| 800  | 768.5  | 25x38 |
| 1200 | 1168.5 | 25x38 |
| 1500 | 1468.5 | 25x38 |

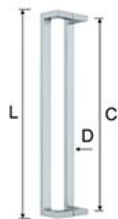
**EHD-804**

材质: 不锈钢  
 表面处理: 砂光、镜光、钛金  
 Material: Stainless steel  
 Finish: Satin Stainless Steel (SSS)  
 Polished Stainless Steel (PSS)  
 Titanium Plated (Ti)

## 规格/Size

| L    | C/C  | D     |
|------|------|-------|
| 800  | 775  | 25x38 |
| 1200 | 1175 | 25x38 |
| 1500 | 1475 | 25x38 |

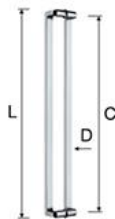
**EHD-808**

材质: 不锈钢  
 表面处理: 砂光、镜光、钛金  
 Material: Stainless steel  
 Finish: Satin Stainless Steel (SSS)  
 Polished Stainless Steel (PSS)  
 Titanium Plated (Ti)

## 规格/Size

| L    | C/C  | D     |
|------|------|-------|
| 800  | 775  | 25x38 |
| 1200 | 1175 | 25x38 |

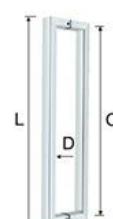
**EHD-816**

材质: 不锈钢  
 表面处理: 砂光、镜光、钛金  
 Material: Stainless steel  
 Finish: Satin Stainless Steel (SSS)  
 Polished Stainless Steel (PSS)  
 Titanium Plated (Ti)

## 规格/Size

| L   | C/C | D     |
|-----|-----|-------|
| 300 | 285 | 30x15 |
| 400 | 385 | 30x15 |
| 600 | 575 | 38x25 |
| 800 | 775 | 38x25 |

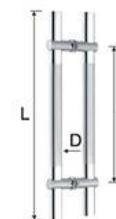
**EHD-817**

材质: 不锈钢  
 表面处理: 砂光、镜光、钛金  
 Material: Stainless steel  
 Finish: Satin Stainless Steel (SSS)  
 Polished Stainless Steel (PSS)  
 Titanium Plated (Ti)

## 规格/Size

| L    | C/C | D     |
|------|-----|-------|
| 600  | 400 | 25x45 |
| 800  | 500 | 25x45 |
| 1200 | 800 | 25x45 |

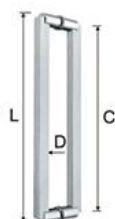
**EHD-812**

材质: 不锈钢  
 表面处理: 砂光、镜光、钛金  
 Material: Stainless steel  
 Finish: Satin Stainless Steel (SSS)  
 Polished Stainless Steel (PSS)  
 Titanium Plated (Ti)

## 规格/Size

| L        | C/C | D     |
|----------|-----|-------|
| 600-1800 | /   | 25x38 |

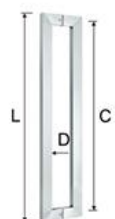
**EHD-815**

材质: 不锈钢  
 表面处理: 砂光、镜光、钛金  
 Material: Stainless steel  
 Finish: Satin Stainless Steel (SSS)  
 Polished Stainless Steel (PSS)  
 Titanium Plated (Ti)

## 规格/Size

| L    | C/C  | D     |
|------|------|-------|
| 600  | 562  | 25x38 |
| 800  | 762  | 25x38 |
| 1000 | 962  | 25x38 |
| 1200 | 1162 | 25x38 |
| 1500 | 1462 | 25x38 |

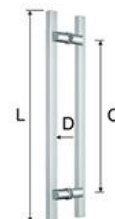
**EHD-822**

材质: 不锈钢  
 表面处理: 砂光、镜光、钛金  
 Material: Stainless steel  
 Finish: Satin Stainless Steel (SSS)  
 Polished Stainless Steel (PSS)  
 Titanium Plated (Ti)

## 规格/Size

| L   | C/C | D     |
|-----|-----|-------|
| 600 | 400 | 25x38 |
| 800 | 600 | 25x45 |

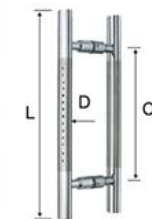
**EHD-829**

材质: 不锈钢  
 表面处理: 砂光、镜光、钛金  
 Material: Stainless steel  
 Finish: Satin Stainless Steel (SSS)  
 Polished Stainless Steel (PSS)  
 Titanium Plated (Ti)

## 规格/Size

| L   | C/C | D     |
|-----|-----|-------|
| 300 | 200 | 30x15 |

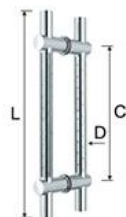
**EHD-832**

材质: 不锈钢  
 表面处理: 砂光、镜光、钛金  
 Material: Stainless steel  
 Finish: Satin Stainless Steel (SSS)  
 Polished Stainless Steel (PSS)  
 Titanium Plated (Ti)

## 规格/Size

| L    | C/C | D   |
|------|-----|-----|
| 600  | 400 | Φ25 |
| 800  | 500 | Φ25 |
| 1200 | 800 | Φ25 |

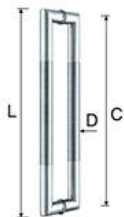
**EHD-834**

材质: 不锈钢  
 表面处理: 砂光、镜光、钛金  
 Material: Stainless steel  
 Finish: Satin Stainless Steel (SSS)  
 Polished Stainless Steel (PSS)  
 Titanium Plated (Ti)

## 规格/Size

| L   | C/C | D   |
|-----|-----|-----|
| 600 | /   | Φ38 |
| 900 | /   | Φ38 |

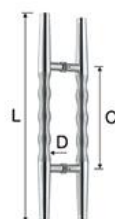
**EHD-837**

材质: 不锈钢  
 表面处理: 砂光、镜光、钛金  
 Material: Stainless steel  
 Finish: Satin Stainless Steel (SSS)  
 Polished Stainless Steel (PSS)  
 Titanium Plated (Ti)

## 规格/Size

| L   | C/C | D   |
|-----|-----|-----|
| 600 | 300 | Φ38 |

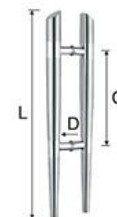
**EHD-838**

材质: 不锈钢  
 表面处理: 砂光、镜光、钛金  
 Material: Stainless steel  
 Finish: Satin Stainless Steel (SSS)  
 Polished Stainless Steel (PSS)  
 Titanium Plated (Ti)

## 规格/Size

| L   | C/C | D   |
|-----|-----|-----|
| 450 | 225 | Φ32 |
| 600 | 330 | Φ38 |
| 800 | 450 | Φ38 |

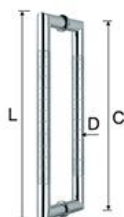
**EHD-835**

材质: 不锈钢  
 表面处理: 砂光、镜光、钛金  
 Material: Stainless steel  
 Finish: Satin Stainless Steel (SSS)  
 Polished Stainless Steel (PSS)  
 Titanium Plated (Ti)

## 规格/Size

| L   | C/C | D   |
|-----|-----|-----|
| 620 | 600 | Φ38 |
| 820 | 800 | Φ38 |

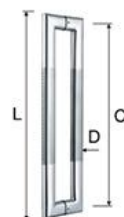
**EHD-836**

材质: 不锈钢  
 表面处理: 砂光、镜光、钛金  
 Material: Stainless steel  
 Finish: Satin Stainless Steel (SSS)  
 Polished Stainless Steel (PSS)  
 Titanium Plated (Ti)

## 规格/Size

| L   | C/C | D     |
|-----|-----|-------|
| 600 | 555 | 25x45 |
| 800 | 755 | 25x45 |

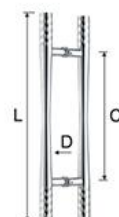
**EHD-839**

材质: 不锈钢  
 表面处理: 砂光、镜光、钛金  
 Material: Stainless steel  
 Finish: Satin Stainless Steel (SSS)  
 Polished Stainless Steel (PSS)  
 Titanium Plated (Ti)

## 规格/Size

| L   | C/C | D   |
|-----|-----|-----|
| 300 | 150 | Φ38 |
| 600 | 400 | Φ38 |

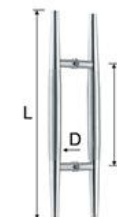
**EHD-840**

材质: 不锈钢  
 表面处理: 砂光、镜光、钛金  
 Material: Stainless steel  
 Finish: Satin Stainless Steel (SSS)  
 Polished Stainless Steel (PSS)  
 Titanium Plated (Ti)

## 规格/Size

| L   | C/C | D   |
|-----|-----|-----|
| 600 | 400 | Φ38 |



**EHD-841**

材质: 不锈钢  
表面处理: 砂光、镜光、钛金  
Material: Stainless steel  
Finish: Satin Stainless Steel (SSS)  
Polished Stainless Steel (PSS)  
Titanium Plated (Ti)

规格/Size

| L   | C/C | D   |
|-----|-----|-----|
| 600 | 400 | Φ38 |



**EHD-843**

材质: 不锈钢  
表面处理: 砂光、镜光、钛金  
Material: Stainless steel  
Finish: Satin Stainless Steel (SSS)  
Polished Stainless Steel (PSS)  
Titanium Plated (Ti)

规格/Size

| L        | C/C | D   |
|----------|-----|-----|
| 600-1800 | /   | Φ38 |



**EHD-851**

材质: 不锈钢  
表面处理: 砂光、镜光、钛金  
Material: Stainless steel  
Finish: Satin Stainless Steel (SSS)  
Polished Stainless Steel (PSS)  
Titanium Plated (Ti)

规格/Size

| L   | C/C | D   |
|-----|-----|-----|
| 600 | 360 | Φ38 |
| 800 | 500 | Φ38 |



**EHD-852**

材质: 不锈钢  
表面处理: 砂光、镜光、钛金  
Material: Stainless steel  
Finish: Satin Stainless Steel (SSS)  
Polished Stainless Steel (PSS)  
Titanium Plated (Ti)

规格/Size

| L    | C/C  | D   |
|------|------|-----|
| 300  | 200  | Φ25 |
| 450  | 300  | Φ32 |
| 600  | 400  | Φ32 |
| 1200 | 800  | Φ38 |
| 1800 | 1400 | Φ38 |



**EHD-844**

材质: 不锈钢  
表面处理: 砂光、镜光、钛金  
Material: Stainless steel  
Finish: Satin Stainless Steel (SSS)  
Polished Stainless Steel (PSS)  
Titanium Plated (Ti)

规格/Size

| L   | C/C | D   |
|-----|-----|-----|
| 600 | 568 | Φ32 |
| 800 | 768 | Φ38 |



**EHD-846**

材质: 不锈钢  
表面处理: 砂光、镜光、钛金  
Material: Stainless steel  
Finish: Satin Stainless Steel (SSS)  
Polished Stainless Steel (PSS)  
Titanium Plated (Ti)

规格/Size

| L    | C/C | D   |
|------|-----|-----|
| 800  | 762 | Φ38 |
| 1000 | 962 | Φ38 |



**EHD-854**

材质: 不锈钢  
表面处理: 砂光、镜光、钛金  
Material: Stainless steel  
Finish: Satin Stainless Steel (SSS)  
Polished Stainless Steel (PSS)  
Titanium Plated (Ti)

规格/Size

| L    | C/C | D   |
|------|-----|-----|
| 800  | 600 | Φ38 |
| 1200 | 900 | Φ38 |



**EHD-858**

材质: 不锈钢  
表面处理: 砂光、镜光、钛金  
Material: Stainless steel  
Finish: Satin Stainless Steel (SSS)  
Polished Stainless Steel (PSS)  
Titanium Plated (Ti)

规格/Size

| L    | C/C  | D   |
|------|------|-----|
| 800  | 600  | Φ38 |
| 1200 | 1000 | Φ38 |

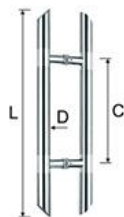
**EHD-860**

材质: 不锈钢  
 表面处理: 砂光、镜光、钛金  
 Material: Stainless steel  
 Finish: Satin Stainless Steel (SSS)  
 Polished Stainless Steel (PSS)  
 Titanium Plated (Ti)

## 规格/Size

| L    | C/C | D   |
|------|-----|-----|
| 600  | 500 | Φ38 |
| 1200 | 800 | Φ38 |

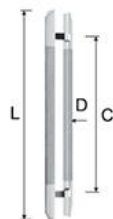
**EHD-862**

材质: 不锈钢  
 表面处理: 砂光、镜光、钛金  
 Material: Stainless steel  
 Finish: Satin Stainless Steel (SSS)  
 Polished Stainless Steel (PSS)  
 Titanium Plated (Ti)

## 规格/Size

| L    | C/C | D     |
|------|-----|-------|
| 600  | 400 | 39x39 |
| 800  | 500 | 39x39 |
| 1200 | 800 | 39x39 |

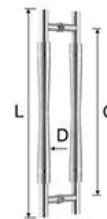
**EHD-869**

材质: 不锈钢  
 表面处理: 砂光、镜光、钛金  
 Material: Stainless steel  
 Finish: Satin Stainless Steel (SSS)  
 Polished Stainless Steel (PSS)  
 Titanium Plated (Ti)

## 规格/Size

| L   | C/C | D   |
|-----|-----|-----|
| 600 | 400 | Φ38 |
| 800 | 500 | Φ38 |

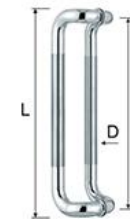
**EHD-873**

材质: 不锈钢  
 表面处理: 砂光、镜光、钛金  
 Material: Stainless steel  
 Finish: Satin Stainless Steel (SSS)  
 Polished Stainless Steel (PSS)  
 Titanium Plated (Ti)

## 规格/Size

| L   | C/C | D   |
|-----|-----|-----|
| 450 | 418 | Φ32 |
| 600 | 568 | Φ32 |

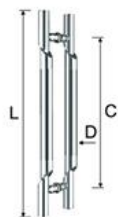
**EHD-865**

材质: 不锈钢  
 表面处理: 砂光、镜光、钛金  
 Material: Stainless steel  
 Finish: Satin Stainless Steel (SSS)  
 Polished Stainless Steel (PSS)  
 Titanium Plated (Ti)

## 规格/Size

| L    | C/C  | D   |
|------|------|-----|
| 800  | 600  | Φ38 |
| 1200 | 1000 | Φ38 |

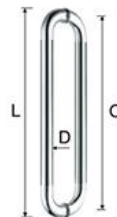
**EHD-866**

材质: 不锈钢  
 表面处理: 砂光、镜光、钛金  
 Material: Stainless steel  
 Finish: Satin Stainless Steel (SSS)  
 Polished Stainless Steel (PSS)  
 Titanium Plated (Ti)

## 规格/Size

| L   | C/C | D   |
|-----|-----|-----|
| 300 | 275 | Φ25 |
| 400 | 375 | Φ25 |
| 500 | 468 | Φ32 |
| 600 | 562 | Φ38 |
| 800 | 762 | Φ38 |

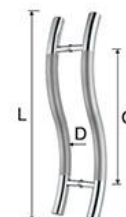
**EHD-876**

材质: 不锈钢  
 表面处理: 砂光、镜光、钛金  
 Material: Stainless steel  
 Finish: Satin Stainless Steel (SSS)  
 Polished Stainless Steel (PSS)  
 Titanium Plated (Ti)

## 规格/Size

| L   | C/C | D   |
|-----|-----|-----|
| 550 | 400 | Φ32 |
| 580 | 400 | Φ38 |

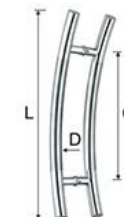
**EHD-877**

材质: 不锈钢  
 表面处理: 砂光、镜光、钛金  
 Material: Stainless steel  
 Finish: Satin Stainless Steel (SSS)  
 Polished Stainless Steel (PSS)  
 Titanium Plated (Ti)

## 规格/Size

| L   | C/C | D   |
|-----|-----|-----|
| 300 | 200 | Φ25 |
| 600 | 400 | Φ38 |
| 800 | 500 | Φ38 |



**EHD-878**

材质: 不锈钢  
表面处理: 砂光、镜光、钛金  
Material: Stainless steel  
Finish: Satin Stainless Steel (SSS)  
Polished Stainless Steel (PSS)  
Titanium Plated (Ti)

规格/Size

| L   | C/C | D     |
|-----|-----|-------|
| 800 | 650 | 45x25 |



**EHD-892**

材质: 不锈钢  
表面处理: 砂光、镜光、钛金  
Material: Stainless steel  
Finish: Satin Stainless Steel (SSS)  
Polished Stainless Steel (PSS)  
Titanium Plated (Ti)

规格/Size

| L    | C/C  | D   |
|------|------|-----|
| 1000 | 962  | Φ38 |
| 1200 | 1162 | Φ38 |



**EHD-889**

材质: 不锈钢  
表面处理: 砂光、镜光、钛金  
Material: Stainless steel  
Finish: Satin Stainless Steel (SSS)  
Polished Stainless Steel (PSS)  
Titanium Plated (Ti)

规格/Size

| L   | C/C     | D     |
|-----|---------|-------|
| 450 | 425/225 | 13x25 |

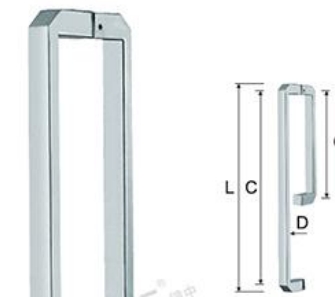

**EHD-911**

材质: 不锈钢  
表面处理: 砂光、镜光、钛金  
Material: Stainless steel  
Finish: Satin Stainless Steel (SSS)  
Polished Stainless Steel (PSS)  
Titanium Plated (Ti)

规格/Size

| L   | C/C     | D     |
|-----|---------|-------|
| 450 | 425/225 | 13x25 |



**EHD-882**

材质: 不锈钢  
表面处理: 砂光、镜光、钛金  
Material: Stainless steel  
Finish: Satin Stainless Steel (SSS)  
Polished Stainless Steel (PSS)  
Titanium Plated (Ti)

规格/Size

| L       | C/C     | D   |
|---------|---------|-----|
| 200x400 | 181x381 | Φ19 |
| 250x450 | 231x431 | Φ19 |
| 300x500 | 275x475 | Φ25 |



**EHD-883**

材质: 不锈钢  
表面处理: 砂光、镜光、钛金  
Material: Stainless steel  
Finish: Satin Stainless Steel (SSS)  
Polished Stainless Steel (PSS)  
Titanium Plated (Ti)

规格/Size

| L       | C/C     | D   |
|---------|---------|-----|
| 400x200 | 275/175 | Φ25 |



**EHD-912**

材质: 不锈钢  
表面处理: 砂光、镜光、钛金  
Material: Stainless steel  
Finish: Satin Stainless Steel (SSS)  
Polished Stainless Steel (PSS)  
Titanium Plated (Ti)

规格/Size

| L   | C/C     | D     |
|-----|---------|-------|
| 450 | 425/225 | 13x25 |



**EHD-913**

材质: 不锈钢  
表面处理: 砂光、镜光、钛金  
Material: Stainless steel  
Finish: Satin Stainless Steel (SSS)  
Polished Stainless Steel (PSS)  
Titanium Plated (Ti)

规格/Size

| L   | C/C     | D    |
|-----|---------|------|
| 450 | 425/225 | 5x25 |



**EHD-885**

材质: 不锈钢  
表面处理: 砂光、镜光、钛金  
Material: Stainless steel  
Finish: Satin Stainless Steel (SSS)  
Polished Stainless Steel (PSS)  
Titanium Plated (Ti)

规格/Size

| L   | C/C | D   |
|-----|-----|-----|
| 300 | 275 | Φ25 |

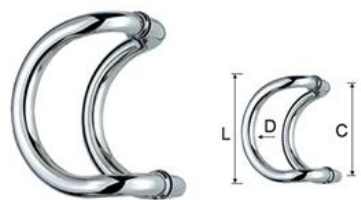

**EHD-887**

材质: 不锈钢  
表面处理: 砂光、镜光、钛金  
Material: Stainless steel  
Finish: Satin Stainless Steel (SSS)  
Polished Stainless Steel (PSS)  
Titanium Plated (Ti)

规格/Size

| L   | C/C | D   |
|-----|-----|-----|
| 300 | 275 | Φ25 |



**EHD-893**

材质: 不锈钢  
表面处理: 砂光、镜光、钛金  
Material: Stainless steel  
Finish: Satin Stainless Steel (SSS)  
Polished Stainless Steel (PSS)  
Titanium Plated (Ti)

规格/Size

| L   | C/C | D   |
|-----|-----|-----|
| 300 | 275 | Φ25 |



**EHD-896**

材质: 不锈钢  
表面处理: 砂光、镜光、钛金  
Material: Stainless steel  
Finish: Satin Stainless Steel (SSS)  
Polished Stainless Steel (PSS)  
Titanium Plated (Ti)

规格/Size

| L   | C/C | D   |
|-----|-----|-----|
| 300 | 200 | Φ25 |



**EHD-905**

材质: 铝合金  
表面处理: 电泳  
Material: Aluminium  
Finish: Electrophoresis

规格/Size

| L        | C/C | D   |
|----------|-----|-----|
| 600-3000 | /   | Φ40 |



**EHD-906**

材质: 铝合金  
表面处理: 电泳  
Material: Aluminium  
Finish: Electrophoresis

规格/Size

| L        | C/C | D   |
|----------|-----|-----|
| 600-3000 | /   | Φ40 |



**EHD-907**

材质: 铝合金  
表面处理: 电泳  
Material: Aluminium  
Finish: Electrophoresis



**EHD-908**

材质: 铝合金  
表面处理: 电泳  
Material: Aluminium  
Finish: Electrophoresis

规格/Size

| L        | C/C | D   |
|----------|-----|-----|
| 600-3000 | /   | Φ40 |



**EHD-909**

材质: 铝合金  
表面处理: 电泳  
Material: Aluminium  
Finish: Electrophoresis



EHD-835B EHD-835A



EHD-836B EHD-836A

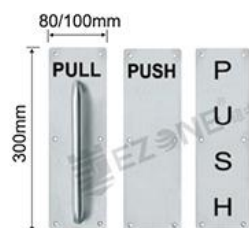

EHD-837C EHD-837A EHD-837B



EHD-838B EHD-838A



EHD-839A



EHD-840A



EHD-841A



EHD-842A



EHD-843A



EHD-844A



EHD-845A



EHD-846A



EHD-847A



EHD-848A



EHD-849A



EHD-850A



EHD-851A



EHD-852A



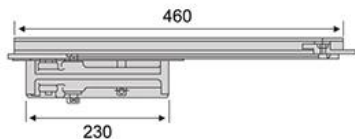
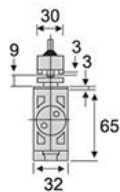

| 型号<br>Model | 适用门重<br>Door Weight | 适用门宽<br>Door Size | 产品适用<br>Application                    |
|-------------|---------------------|-------------------|--|
| EDC-081     | 40-65               | 600-1100mm        | 各种材质金属及塑钢门<br>All metal & plastic door |

90° 定位180° 无定位  
90° hold open and 180° Non hold-open  
适用温度: -40℃-60℃  
Suitable temperature: -40℃-60℃

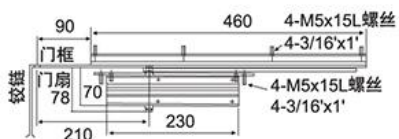
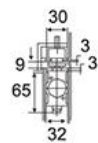

| 型号<br>Model | 适用门重<br>Door Weight | 适用门宽<br>Door Size | 产品适用<br>Application                    |
|-------------|---------------------|-------------------|--|
| EDC-081K    | 40-65               | 600-1100mm        | 各种材质金属及塑钢门<br>All metal & plastic door |

90° 定位180° 无定位  
90° hold open and 180° Non hold-open  
适用温度: -40℃-60℃  
Suitable temperature: -40℃-60℃

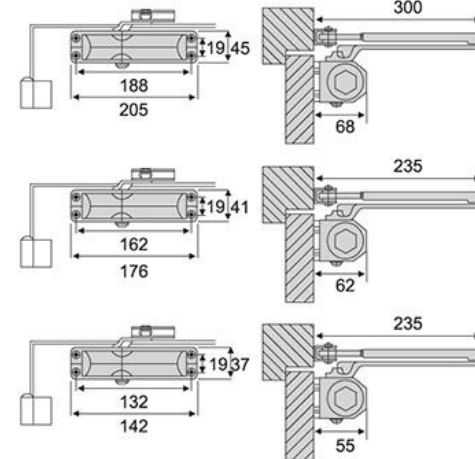
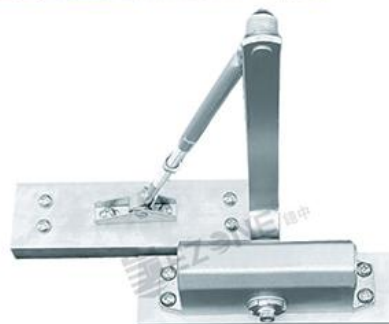

| 型号<br>Model | 安装尺寸<br>Dimension | 适用门重<br>Door Weight | 适用门宽<br>Door Size | 产品适用<br>Application                    |
|-------------|-------------------|---------------------|-------------------|--|
| EDC-060A    | 188x19mm          | 65-85               | 800-1050mm        | 各种材质金属及塑钢门<br>All metal & plastic door |
| EDC-060B    | 162x19mm          | 40-65               | 550-950mm         |  |
| EDC-060C    | 132x19mm          | 25-35               | 500-900mm         |  |

90° 定位180° 无定位  
90° hold open and 180° Non hold-open  
适用温度: -40℃-60℃  
Suitable temperature: -40℃-60℃

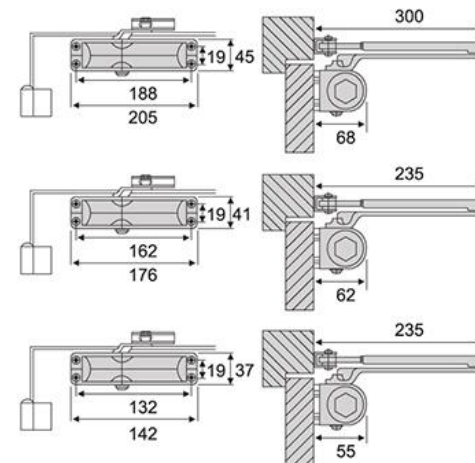

| 型号<br>Model   | 安装尺寸<br>Dimension | 适用门重<br>Door Weight | 适用门宽<br>Door Size | 产品适用<br>Application                    |
|---------------|-------------------|---------------------|-------------------|--|
| EDC-061A/062A | 188x19mm          | 65-85               | 800-1050mm        | 各种材质金属及塑钢门<br>All metal & plastic door |
| EDC-061B/062B | 162x19mm          | 40-65               | 550-950mm         |  |
| EDC-061C/062C | 132x19mm          | 25-35               | 500-900mm         |  |

90° 定位180° 无定位  
90° hold open and 180° Non hold-open  
适用温度: -40℃-60℃  
Suitable temperature: -40℃-60℃

功能特点 Functional Characteristics:

| 规格Size                    | 4 Inch   | 5 Inch                                  | 6 Inch                                  |
|---------------------------|--|---|---|
| 型号Model                   | E type   | E type                                  | E type                                  |
| 最大承重<br>Weight capacity   | < 20kg/pcs   | < 30kg/pcs                              | < 40kg/pcs                              |
| 适用门宽<br>Door width        | < 900mm  | < 1050mm                                | < 1200mm                                |
| 使用寿命<br>Service life      | 30万次以上<br>More than 300000 times   | 30万次以上<br>More than 300000 times        | 50万次以上<br>More than 500000 times        |
| 外形尺寸<br>Size(mm)          | 141x86xΦ22.5<br>页片尺寸Page size:130x30x3.5   | 148x100xΦ26<br>页片尺寸Page size:138x36x3.5 | 170x101xΦ28<br>页片尺寸Page size:160x36x3.5 |
| 开槽方式<br>Slotting method   | 开槽宽度35±0.5-0mm,单边开槽深度4mm<br>Width of grooves is 35±0.5-0mm,depth of single grooves is 4mm  |   |   |
| 开启方向<br>Opening Direction | 单方向开启,最大角度170°,安装方向不分左右<br>Open in one direction, maximum angle 170°, installed without direction left and right.  |   |   |
| 适用温度<br>Temperature       | (-30℃)-60℃   |   |   |
| 适用门类<br>Suitable          | 防火门、木门、铝合金门等酒店、KTV、办公楼、家用门等室内门<br>Fire doors, wooden doors, aluminum doors, etc.Hotel, KTV, office building, door and other indoor door.                                     |   |   |
| 注意<br>Note                | 不锈钢页片厚度3mm<br>Stainless steel sheet thickness 3mm  |   |   |
| 调速控制<br>Speed control     | 关门力度可任意调整;静音、入锁功能可随时切换<br>The closing force can be adjusted at will; The mutes and lock functions can be switched at any time.   |   |   |
| 功能<br>Function            | 具有液压、三速缓冲、吸收冲击力功能,<br>可选90°后任意定位功能和180°全自动功能<br>With hydraulic, three-speed buffer, shock absorption function, Optional 90° positioning function and 180° automatic function |   |   |

安装合页到门扇上时注意按合页上的↑方向。  
调试关门效果(速度、力度的调节孔分别位于液压页的两端装饰盖内)

- 调节方法: 1:先把力度调节阀门转动使力度减小才可以打开合页  
2:把合页打开后把力度调节阀门转动使力度增加再安装合页的固定螺丝;  
3:根据门的实际情况去调节速度阀门,使门的速度达到理想效果。  
4:调节力度的时候,请把门关闭状态去调大关门力度。

Pay attention to the hinges when installing hinges on the door ↑ Direction.  
Adjust the closing effect (the adjusting holes for speed and force are located in the decorative covers at both ends of the hydraulic page)

Adjustment method:

- 1: First turn the strength adjustment valve to reduce the strength before opening the hinge
- 2: After opening the hinge, rotate the strength regulating valve to increase the strength and then install the fixing screw of the hinge;
- 3: According to the actual situation of the door to adjust the speed valve, so that the door speed to achieve the ideal effect.
- 4: When adjusting the strength, please close the door to adjust the strength of the door.

速度、力度的调节孔分别位于液压页的两端  
The speed and strength are adjusted at both ends of the hinge

★请把门关上再去调节力度

力度调节方法



顺时针转动速度调节阀门使关门力度增大  
逆时针转动速度调节阀门使关门力度减少

速度调节方法



顺时针转动速度调节阀门使关门速度减慢  
逆时针转动速度调节阀门使关门速度加快



90



EDC-110

E型5寸液压合页(不分左右)

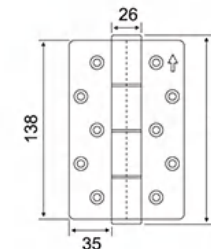

材质:太空铝,不锈钢  
表面处理:砂金,青古铜,红古铜,砂银,砂黑  
Material: Space Aluminum, Stainless Steel  
Surface Treatment: Gold, Green Bronze, Red Bronze, Silver, Black



EDC-120

E型6寸液压合页(不分左右)

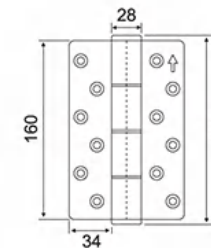

材质:太空铝,不锈钢  
表面处理:砂金,青古铜,红古铜,砂银,砂黑  
Material: Space Aluminum, Stainless Steel  
Surface Treatment: Gold, Green Bronze, Red Bronze, Silver, Black



EDC-130

E型5寸玻璃液压合页(双门)

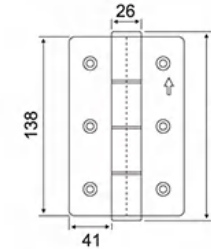

材质:太空铝,不锈钢  
表面处理:砂金,青古铜,红古铜,砂银,砂黑  
Material: Space Aluminum, Stainless Steel  
Surface Treatment: Gold, Green Bronze, Red Bronze, Silver, Black

91



楼梯立柱系列  
Stair Handrail Series  
**YOUR GLASS SOLUTION**  
LEIPANG GLASS HARDWARE MANUFACTURER



**ECS-601**

表面处理: 砂面、亮光  
主要材质: 不锈钢  
Finish: Satin, Polished  
Material: Stainless steel

**ECS-602**

表面处理: 砂面、亮光  
主要材质: 不锈钢  
Finish: Satin, Polished  
Material: Stainless steel

**ECS-603**

表面处理: 砂面、亮光  
主要材质: 不锈钢  
Finish: Satin, Polished  
Material: Stainless steel



**ECS-604**

表面处理: 砂面、亮光  
主要材质: 不锈钢  
Finish: Satin, Polished  
Material: Stainless steel

**ECS-605**

表面处理: 砂面、亮光  
主要材质: 不锈钢  
Finish: Satin, Polished  
Material: Stainless steel

**ECS-606**

表面处理: 砂面、亮光  
主要材质: 不锈钢  
Finish: Satin, Polished  
Material: Stainless steel



**ECS-607**

表面处理: 砂面、亮光  
主要材质: 不锈钢  
Finish: Satin, Polished  
Material: Stainless steel

**ECS-608**

表面处理: 砂面、亮光  
主要材质: 不锈钢  
Finish: Satin, Polished  
Material: Stainless steel

**ECS-609**

表面处理: 砂面、亮光  
主要材质: 不锈钢  
Finish: Satin, Polished  
Material: Stainless steel



**ECS-611**

表面处理: 砂面、亮光  
主要材质: 不锈钢  
Finish: Satin, Polished  
Material: Stainless steel



**ECS-612**

表面处理: 砂面、亮光  
主要材质: 不锈钢  
Finish: Satin, Polished  
Material: Stainless steel



**ECS-615**

表面处理: 砂面、亮光  
主要材质: 不锈钢  
Finish: Satin, Polished  
Material: Stainless steel



**ECS-639**

Material: SUS304 / SUS316

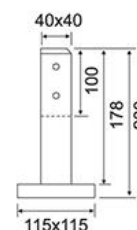

**ECS-640**

Material: Aluminum alloy

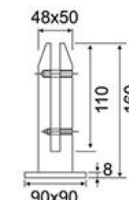

**ECS-641**

Material: SUS304 / SUS316

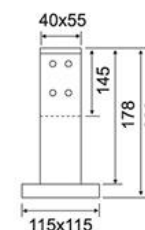

**ECS-642**

Material: Aluminum alloy

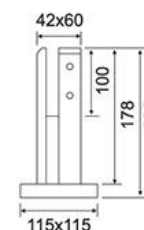

**ECS-643**

Material: Aluminum alloy



|  |   |            |      |      |   |
|--|---|------------|------|------|---|
| <br>ECS-001 |  | Size(mm)   | A    | B    | C |
|  |   | ECS-001-25 | 25.4 | 25.4 |   |
|  |   | ECS-001-38 | 38.1 | 38.1 |   |
|  |   | ECS-001-51 | 50.8 | 50.8 |   |

|  |   |            |      |      |   |
|--|---|------------|------|------|---|
| <br>ECS-002 |  | Size(mm)   | A    | B    | C |
|  |   | ECS-002-38 | 38.1 | 38.1 |   |
|  |   | ECS-002-51 | 50.8 | 50.8 |   |

|  |   |            |      |      |   |
|--|---|------------|------|------|---|
| <br>ECS-003 |  | Size(mm)   | A    | B    | C |
|  |   | ECS-003-38 | 38.1 | 38.1 |   |
|  |   | ECS-003-51 | 50.8 | 50.8 |   |

|  |   |            |      |      |   |
|--|---|------------|------|------|---|
| <br>ECS-004 |  | Size(mm)   | A    | B    | C |
|  |   | ECS-004-38 | 38.1 | 38.1 |   |
|  |   | ECS-004-51 | 50.8 | 50.8 |   |

|   |  |            |      |      |   |
|---|--|------------|------|------|---|
| <br>ECS-005 |  | Size(mm)   | A    | B    | C |
|   |  | ECS-005-38 | 38.1 | 38.1 |   |
|   |  | ECS-005-51 | 50.8 | 50.8 |   |

|   |  |            |      |      |   |
|---|--|------------|------|------|---|
| <br>ECS-006 |  | Size(mm)   | A    | B    | C |
|   |  | ECS-006-25 | 25.4 | 50.8 |   |

|  |   |            |      |      |   |
|--|---|------------|------|------|---|
| <br>ECS-007 |  | Size(mm)   | A    | B    | C |
|  |   | ECS-007-38 | 38.1 | 38.1 |   |
|  |   | ECS-007-51 | 50.8 | 50.8 |   |

|  |   |            |      |      |   |
|--|---|------------|------|------|---|
| <br>ECS-008 |  | Size(mm)   | A    | B    | C |
|  |   | ECS-008-38 | 38.1 | 38.1 |   |
|  |   | ECS-008-51 | 50.8 | 50.8 |   |

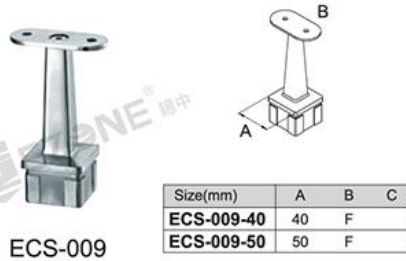

| Size(mm)   | A  | B | C |
|------------|----|---|---|
| ECS-009-40 | 40 | F |   |
| ECS-009-50 | 50 | F |   |

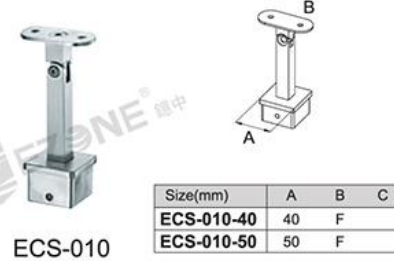

| Size(mm)   | A  | B | C |
|------------|----|---|---|
| ECS-010-40 | 40 | F |   |
| ECS-010-50 | 50 | F |   |

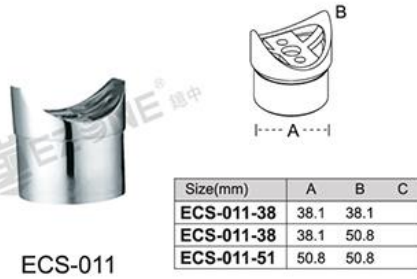

| Size(mm)   | A    | B    | C |
|------------|------|------|---|
| ECS-011-38 | 38.1 | 38.1 |   |
| ECS-011-38 | 38.1 | 50.8 |   |
| ECS-011-51 | 50.8 | 50.8 |   |



| Size(mm)   | A    | B    | C |
|------------|------|------|---|
| ECS-012-38 | 38.1 | 38.1 |   |
| ECS-012-38 | 38.1 | 50.8 |   |
| ECS-012-51 | 50.8 | 50.8 |   |



| Size(mm)   | A    | B    | C |
|------------|------|------|---|
| ECS-013-38 | 38.1 | 38.1 |   |
| ECS-013-38 | 38.1 | 50.8 |   |
| ECS-013-51 | 50.8 | 50.8 |   |

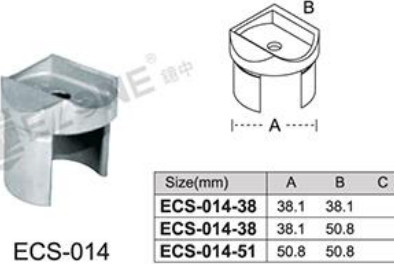

| Size(mm)   | A    | B    | C |
|------------|------|------|---|
| ECS-014-38 | 38.1 | 38.1 |   |
| ECS-014-38 | 38.1 | 50.8 |   |
| ECS-014-51 | 50.8 | 50.8 |   |



| Size(mm)   | A    | B    | C |
|------------|------|------|---|
| ECS-015-38 | 38.1 | 38.1 |   |
| ECS-015-51 | 50.8 | 50.8 |   |

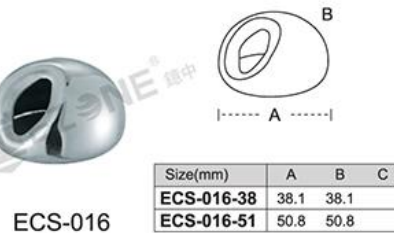

| Size(mm)   | A    | B    | C |
|------------|------|------|---|
| ECS-016-38 | 38.1 | 38.1 |   |
| ECS-016-51 | 50.8 | 50.8 |   |



| Size(mm)   | A | B    | C |
|------------|---|------|---|
| ECS-017-38 |   | 38.1 |   |
| ECS-017-51 |   | 50.8 |   |
| ECS-017-F  |   | F    |   |



| Size(mm)   | A | B    | C |
|------------|---|------|---|
| ECS-018-38 |   | 38.1 |   |
| ECS-018-51 |   | 50.8 |   |
| ECS-018-F  |   | F    |   |



| Size(mm) | A | B | C |
|----------|---|---|---|
| ECS-019  |   |   |   |



| Size(mm) | A | B | C |
|----------|---|---|---|
| ECS-020  |   |   |   |

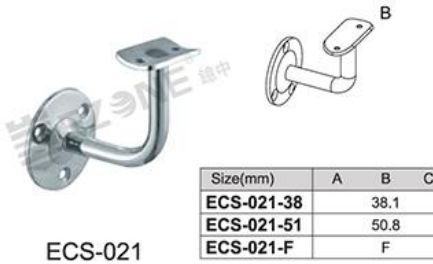

| Size(mm)   | A | B    | C |
|------------|---|------|---|
| ECS-021-38 |   | 38.1 |   |
| ECS-021-51 |   | 50.8 |   |
| ECS-021-F  |   | F    |   |



| Size(mm)   | A | B    | C |
|------------|---|------|---|
| ECS-022-38 |   | 38.1 |   |
| ECS-022-51 |   | 50.8 |   |
| ECS-022-F  |   | F    |   |



| Size(mm)   | A | B    | C |
|------------|---|------|---|
| ECS-023-38 |   | 38.1 |   |
| ECS-023-51 |   | 50.8 |   |
| ECS-023-F  |   | F    |   |



| Size(mm)   | A | B    | C |
|------------|---|------|---|
| ECS-024-38 |   | 38.1 |   |
| ECS-024-51 |   | 50.8 |   |
| ECS-024-F  |   | F    |   |

**ECS-025**

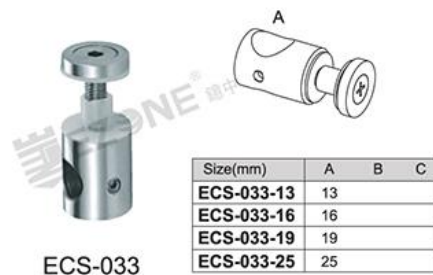
**ECS-026**

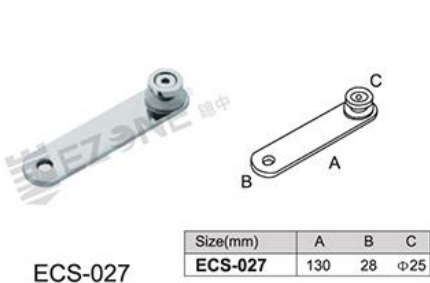
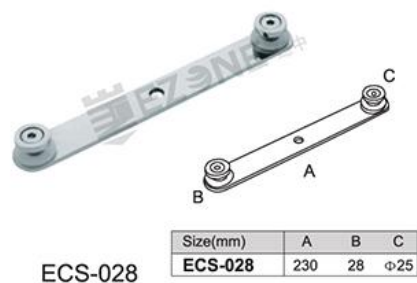
**ECS-033**

**ECS-034**

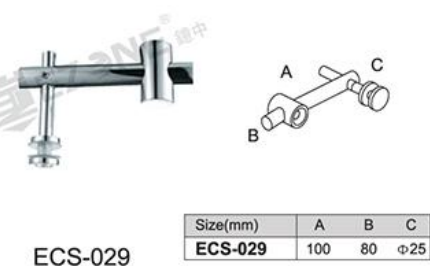
**ECS-027**

**ECS-028**

**ECS-035**

**ECS-036**

**ECS-029**

**ECS-030**

**ECS-037**

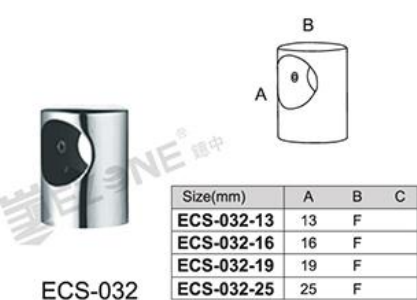
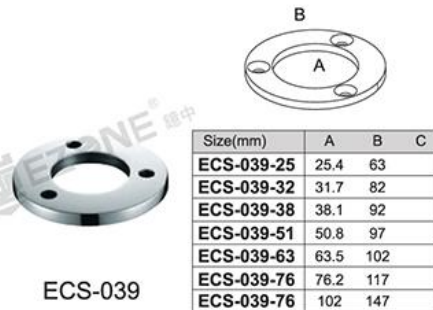
**ECS-038**

**ECS-031**

**ECS-032**

**ECS-039**

**ECS-040**



ECS-041

| Size(mm)          | A  | B  | C |
|-------------------|----|----|---|
| <b>ECS-041-40</b> | 40 | 40 |   |
| <b>ECS-041-50</b> | 50 | 50 |   |



ECS-042

| Size(mm)          | A    | B | C |
|-------------------|------|---|---|
| <b>ECS-042-38</b> | 38.1 |   |   |
| <b>ECS-042-51</b> | 50.8 |   |   |



ECS-049

| Size(mm)          | A    | B   | C |
|-------------------|------|-----|---|
| <b>ECS-049-38</b> | 38.1 | 100 |   |
| <b>ECS-049-51</b> | 50.8 | 100 |   |

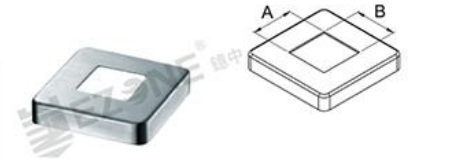

ECS-050

| Size(mm)          | A  | B  | C |
|-------------------|----|----|---|
| <b>ECS-050-40</b> | 40 | 40 |   |
| <b>ECS-050-50</b> | 50 | 50 |   |



ECS-043

| Size(mm)          | A    | B | C |
|-------------------|------|---|---|
| <b>ECS-043-38</b> | 38.1 |   |   |
| <b>ECS-043-51</b> | 50.8 |   |   |



ECS-044

| Size(mm)          | A    | B | C |
|-------------------|------|---|---|
| <b>ECS-044-38</b> | 38.1 |   |   |
| <b>ECS-044-51</b> | 50.8 |   |   |



ECS-051

| Size(mm)          | A    | B   | C |
|-------------------|------|-----|---|
| <b>ECS-051-25</b> | 25.4 | 84  |   |
| <b>ECS-051-38</b> | 38.1 | 105 |   |
| <b>ECS-051-51</b> | 50.8 | 125 |   |



ECS-052

| Size(mm)          | A    | B   | C |
|-------------------|------|-----|---|
| <b>ECS-052-25</b> | 25.4 | 84  |   |
| <b>ECS-052-38</b> | 38.1 | 105 |   |
| <b>ECS-052-51</b> | 50.8 | 125 |   |



ECS-045

| Size(mm)          | A    | B | C |
|-------------------|------|---|---|
| <b>ECS-045-38</b> | 38.1 |   |   |
| <b>ECS-045-51</b> | 50.8 |   |   |

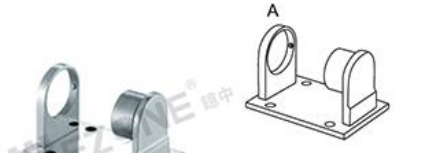

ECS-046

| Size(mm)          | A    | B | C |
|-------------------|------|---|---|
| <b>ECS-046-38</b> | 38.1 |   |   |
| <b>ECS-046-51</b> | 50.8 |   |   |



ECS-053

| Size(mm)          | A    | B   | C |
|-------------------|------|-----|---|
| <b>ECS-053-25</b> | 25.4 | 150 |   |
| <b>ECS-053-38</b> | 38.1 | 150 |   |
| <b>ECS-053-51</b> | 50.8 | 150 |   |



ECS-054

| Size(mm)          | A    | B   | C |
|-------------------|------|-----|---|
| <b>ECS-054-25</b> | 25.4 | 150 |   |
| <b>ECS-054-38</b> | 38.1 | 150 |   |
| <b>ECS-054-51</b> | 50.8 | 150 |   |

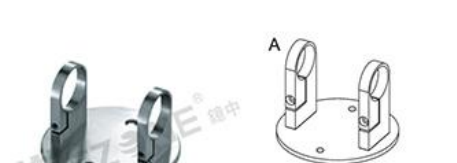

ECS-047

| Size(mm)          | A    | B | C |
|-------------------|------|---|---|
| <b>ECS-047-38</b> | 38.1 |   |   |
| <b>ECS-047-51</b> | 50.8 |   |   |



ECS-048

| Size(mm)           | A    | B      | C |
|--------------------|------|--------|---|
| <b>ECS-048-32</b>  | 31.7 | 84     |   |
| <b>ECS-048-38</b>  | 38.1 | 84/105 |   |
| <b>ECS-048-51</b>  | 50.8 | 84/105 |   |
| <b>ECS-048-63</b>  | 63.5 | 105    |   |
| <b>ECS-048-76</b>  | 76.2 | 120    |   |
| <b>ECS-048-102</b> | 102  | 150    |   |





ECS-055

| Size(mm)          | A    | B | C |
|-------------------|------|---|---|
| <b>ECS-055-25</b> | 25.4 |   |   |
| <b>ECS-055-32</b> | 31.7 |   |   |
| <b>ECS-055-38</b> | 38.1 |   |   |
| <b>ECS-055-51</b> | 50.8 |   |   |



ECS-056

| Size(mm)          | A    | B | C |
|-------------------|------|---|---|
| <b>ECS-056-38</b> | 38.1 |   |   |
| <b>ECS-056-51</b> | 50.8 |   |   |

| Size(mm)   | A    | B | C |
|------------|------|---|---|
| ECS-057-19 | 19.1 |   |   |
| ECS-057-25 | 25.4 |   |   |
| ECS-057-32 | 31.7 |   |   |
| ECS-057-38 | 38.1 |   |   |
| ECS-057-51 | 50.8 |   |   |
| ECS-057-63 | 63.5 |   |   |
| ECS-057-76 | 76.2 |   |   |
| ECS-057-76 | 102  |   |   |

ECS-057



| Size(mm)   | A    | B | C |
|------------|------|---|---|
| ECS-058-38 | 38.1 |   |   |
| ECS-058-51 | 50.8 |   |   |

ECS-058



| Size(mm)   | A    | B | C |
|------------|------|---|---|
| ECS-065-38 | 38.1 |   |   |
| ECS-065-51 | 50.8 |   |   |

ECS-065



| Size(mm)   | A    | B | C |
|------------|------|---|---|
| ECS-066-38 | 38.1 |   |   |
| ECS-066-51 | 50.8 |   |   |

ECS-066





| Size(mm)   | A    | B | C |
|------------|------|---|---|
| ECS-059-38 | 38.1 |   |   |
| ECS-059-51 | 50.8 |   |   |

ECS-059



| Size(mm)   | A    | B | C |
|------------|------|---|---|
| ECS-060-38 | 38.1 |   |   |
| ECS-060-51 | 50.8 |   |   |

ECS-060



| Size(mm)   | A    | B    | C |
|------------|------|------|---|
| ECS-067-38 | 38.1 | 38.1 |   |
| ECS-067-51 | 50.8 | 50.8 |   |

ECS-067



| Size(mm)   | A    | B    | C    |
|------------|------|------|------|
| ECS-068-38 | 38.1 | 38.1 | 38.1 |
| ECS-068-51 | 50.8 | 50.8 | 50.8 |

ECS-068





| Size(mm)   | A    | B | C |
|------------|------|---|---|
| ECS-061-38 | 38.1 |   |   |
| ECS-061-51 | 50.8 |   |   |

ECS-061



| Size(mm)   | A    | B | C |
|------------|------|---|---|
| ECS-062-38 | 38.1 |   |   |
| ECS-062-51 | 50.8 |   |   |

ECS-062

| Size(mm)   | A    | B    | C |
|------------|------|------|---|
| ECS-069-38 | 38.1 | 38.1 |   |
| ECS-069-51 | 50.8 | 50.8 |   |

ECS-069



| Size(mm)   | A    | B    | C |
|------------|------|------|---|
| ECS-070-38 | 38.1 | 38.1 |   |
| ECS-070-51 | 50.8 | 50.8 |   |

ECS-070



| Size(mm)   | A    | B | C |
|------------|------|---|---|
| ECS-063-38 | 38.1 |   |   |
| ECS-063-51 | 50.8 |   |   |

ECS-063





| Size(mm)   | A    | B | C |
|------------|------|---|---|
| ECS-064-38 | 38.1 |   |   |
| ECS-064-51 | 50.8 |   |   |

ECS-064



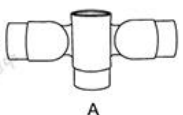

| Size(mm)   | A    | B    | C |
|------------|------|------|---|
| ECS-071-38 | 38.1 | 38.1 |   |
| ECS-071-51 | 50.8 | 50.8 |   |

ECS-071

| Size(mm)   | A    | B    | C |
|------------|------|------|---|
| ECS-072-38 | 38.1 | 38.1 |   |
| ECS-072-51 | 50.8 | 50.8 |   |

ECS-072

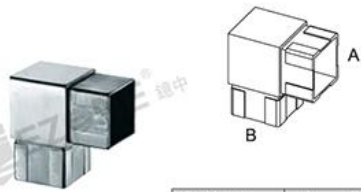

| Size(mm)   | A  | B  | C |
|------------|----|----|---|
| ECS-073-40 | 40 | 40 |   |
| ECS-073-50 | 50 | 50 |   |

ECS-073

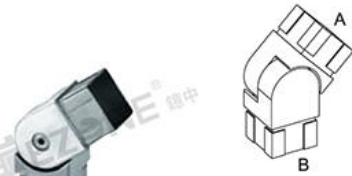

| Size(mm)   | A  | B  | C |
|------------|----|----|---|
| ECS-074-40 | 40 | 40 |   |
| ECS-074-50 | 50 | 50 |   |

ECS-074



| Size(mm)   | A    | B | C |
|------------|------|---|---|
| ECS-075-25 | 25.4 |   |   |
| ECS-075-32 | 31.7 |   |   |
| ECS-075-38 | 38.1 |   |   |
| ECS-075-51 | 50.8 |   |   |
| ECS-075-63 | 63.5 |   |   |
| ECS-075-76 | 76.2 |   |   |

ECS-075

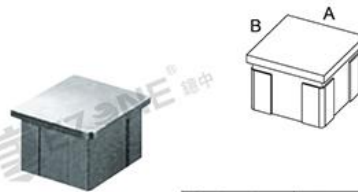

| Size(mm)   | A  | B  | C |
|------------|----|----|---|
| ECS-076-40 | 40 | 40 |   |
| ECS-076-50 | 50 | 50 |   |

ECS-076



| Size(mm)   | A    | B | C |
|------------|------|---|---|
| ECS-077-12 | 12   |   |   |
| ECS-077-13 | 13   |   |   |
| ECS-077-16 | 16   |   |   |
| ECS-077-19 | 19.1 |   |   |
| ECS-077-25 | 25.1 |   |   |

ECS-077



| Size(mm)   | A    | B | C |
|------------|------|---|---|
| ECS-078-25 | 25.4 |   |   |
| ECS-078-38 | 38.1 |   |   |
| ECS-078-51 | 50.8 |   |   |
| ECS-078-63 | 63.5 |   |   |
| ECS-078-76 | 76.2 |   |   |

ECS-078



| Size(mm)    | A    | B | C |
|-------------|------|---|---|
| ECS-079-25  | 25.4 |   |   |
| ECS-079-38  | 38.1 |   |   |
| ECS-079-51  | 50.8 |   |   |
| ECS-079-63  | 63.5 |   |   |
| ECS-079-76  | 76.2 |   |   |
| ECS-079-102 | 102  |   |   |

ECS-079



| Size(mm)    | A    | B | C |
|-------------|------|---|---|
| ECS-080-25  | 25.4 |   |   |
| ECS-080-38  | 38.1 |   |   |
| ECS-080-51  | 50.8 |   |   |
| ECS-080-63  | 63.5 |   |   |
| ECS-080-76  | 76.2 |   |   |
| ECS-080-102 | 102  |   |   |

ECS-080



| Size(mm)   | A    | B | C |
|------------|------|---|---|
| ECS-081-25 | 25.4 |   |   |
| ECS-081-38 | 38.1 |   |   |
| ECS-081-51 | 50.8 |   |   |

ECS-081



| Size(mm)   | A    | B | C |
|------------|------|---|---|
| ECS-082-25 | 25.4 |   |   |
| ECS-082-38 | 38.1 |   |   |
| ECS-082-51 | 50.8 |   |   |

ECS-082



| Size(mm)   | A    | B | C |
|------------|------|---|---|
| ECS-083-12 | 12   |   |   |
| ECS-083-13 | 13   |   |   |
| ECS-083-16 | 16   |   |   |
| ECS-083-19 | 19.1 |   |   |

ECS-083



| Size(mm)   | A    | B | C |
|------------|------|---|---|
| ECS-084-38 | 38.1 |   |   |
| ECS-084-51 | 50.8 |   |   |

ECS-084



| Size(mm)   | A    | B | C |
|------------|------|---|---|
| ECS-085-38 | 38.1 |   |   |
| ECS-085-51 | 50.8 |   |   |

ECS-085



| Size(mm)   | A    | B | C |
|------------|------|---|---|
| ECS-086-38 | 38.1 |   |   |
| ECS-086-51 | 50.8 |   |   |

ECS-086



| Size(mm)   | A    | B   | C |
|------------|------|-----|---|
| ECS-087-25 | 25.4 | 50  |   |
| ECS-087-38 | 38.1 | 60  |   |
| ECS-087-51 | 50.8 | 80  |   |
| ECS-087-63 | 63.5 | 100 |   |
| ECS-087-76 | 76.2 | 110 |   |

ECS-087



| Size(mm)   | A    | B  | C |
|------------|------|----|---|
| ECS-088-38 | 38.1 | 60 |   |
| ECS-088-51 | 50.8 | 80 |   |

ECS-088



卡片



伞



杯

手提袋

信封



牛皮箱



彩箱



笔



笔记本



便签



男工作服



女工作服

