

Specifications and dimensions are purely guideline eummechanicashoes
reserve the right to change specifications without prior notice,printing process
may make the product information with a slight difference in kind, to choose
products which are in kind.



YOUR GLASS SOLUTION
LEIPANG GLASS HARDWARE MANUFACTURER



<https://www.ezonehardware.com>





关于我们 About Us

广东省肇庆市高要区利澎玻璃五金制品厂，是国内外领先的玻璃门控产品、浴室配件制造商，能够独立自主研发和生产玻璃五金配件，是集研发、生产、销售一体化的企业。

我司主营产品包括门控五金，卫浴五金等玻璃五金配件。经过37年的发展，依托雄厚的技术基础和先进的管理理念，拥有多条自动生产线，精密度高控制品质。如今拥有两个厂房和两个展厅，总面积近2万平方米多，其中80%以上的产品出口至亚洲、中东、非洲、东欧、南美和北美。

理念:Your Glass Solution, 我们提供一站式解决方案, 70%的产品由我们自己的工厂生产, 30%由我们高品质的合作伙伴生产, 严控品质要求, 使您的采购变得简单快捷。

我们期待与您建立合作关系, 实现合作双赢!

Leipang Glass hardware Products Factory, Jinli Town Gaoyao District, Zhaoqing City, Guangdong Province, is a leading manufacturer of glass door control products and bathroom accessories at home and abroad, which can independently research and develop and produce glass hardware accessories, and is an enterprise integrating research and development, production and sales.

Our main products include door control hardware, bathroom hardware and other glass hardware accessories. After 37 years of development, relying on strong technical foundation and advanced management concept, we have a number of automatic production lines, high precision and quality control. Now it has two factories and two exhibition halls with a total area of more than 20,000 square meters. More than 80% of its products are exported to Asia, the Middle East, Africa, Eastern Europe, South America and North America.

Concept :Your Glass Solution, we provide one-stop Solution, 70% of our products are produced by our own factory, 30% by our high quality partners, strict control of quality requirements, so that Your purchasing becomes simple and fast.

We look forward to cooperating with you to achieve win-win cooperation!



YOUR GLASS SOLUTION
LEIPANG GLASS HARDWARE MANUFACTURER

智能质造 ◆ 成就未来

精心设计,千锤百炼,成就极至品质,
让我们再创辉煌,
让每个产品都尽善尽美!

Carefully designed, thoroughly tempered,
to achieve the highest quality,
Let's make it great again,
Let every product is perfect!

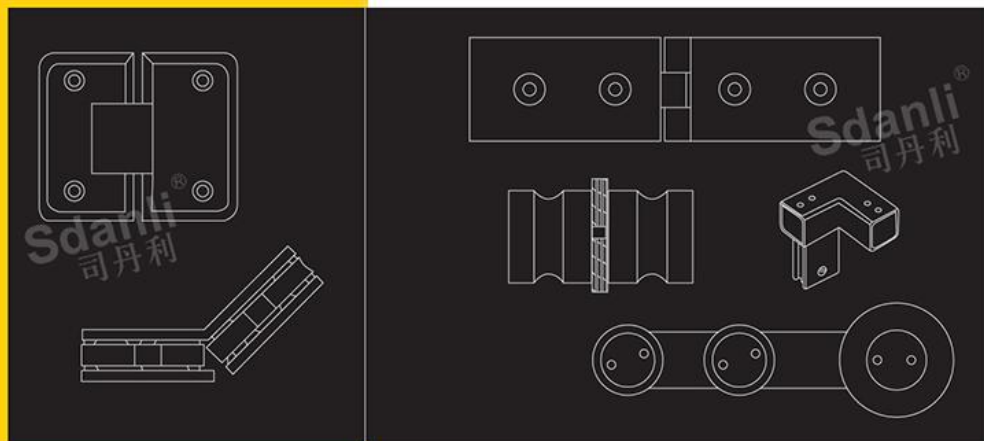

YOUR GLASS

SOLUTION

CONTENTS 目录

淋浴房套件系列 Shower Room Supporting	01-08
浴室玻璃夹系列 Bathroom Glass Clamp	09-20
浴室自由合页系列 Bathroom Hinge Series	21-35
玻璃固定夹系列 Glass Connector Series	36-47
浴室拉杆系列 Bathroom Holder Series	48-50
浴室连接件系列 Bathroom Connector Series	51-53
浴室拉手系列 Bathroom Handles Series	54-55
玻璃门锁 Glass Door Lock Series	56-56
防水胶条系列 PVC Sealing Strip Series	57-58
卫浴镜系列 Bathroom Mirror Series	59-59
折叠门系统 Folding door systems	60-63
移门配件系列 Sliding Wheels Series	64-77
吊轮系列 Hanging Wheel Series	78-78
摇摆门系列 Swing Door Series	79-80
玻璃连接件系列 Glass Connection Series	81-84
幕墙爪件系列 Curtain Wall Series	85-86
家具配件系列 Furniture Fittings Series	87-93



**SHOWER ROOM
SUPPORTING
SERIES**

01



ESC-001

淋浴房套装
Shower room combo

- A. 拉手-1付
- B. 合页-2只
- C. 90° 角码-4只
- D. 吊夹-2只
- E. 135° 转角-2只
- F. 法兰-2只
- G. 下挡水-1套

- A. Handle-1Pair
- B. Hinge-2Pcs
- C. Connector-4Pcs
- D. Clamp-2Pcs
- E. 135° Connector-2Pcs
- F. Partition-2Pcs
- G. Clamp1Set



02



ESC-002

淋浴房套装
Shower room combo

- A. 拉手-1付
- B. 合页-2只
- C. 90° 角码-4只
- D. 吊夹-2只
- E. 135° 转角-2只
- F. 法兰-2只
- G. 下挡水-1套

- A. Handle-1Pair
- B. Hinge-2Pcs
- C. Connector-4Pcs
- D. Clamp-2Pcs
- E. 135° Connector-2Pcs
- F. Partition-2Pcs
- G. Clamp1Set

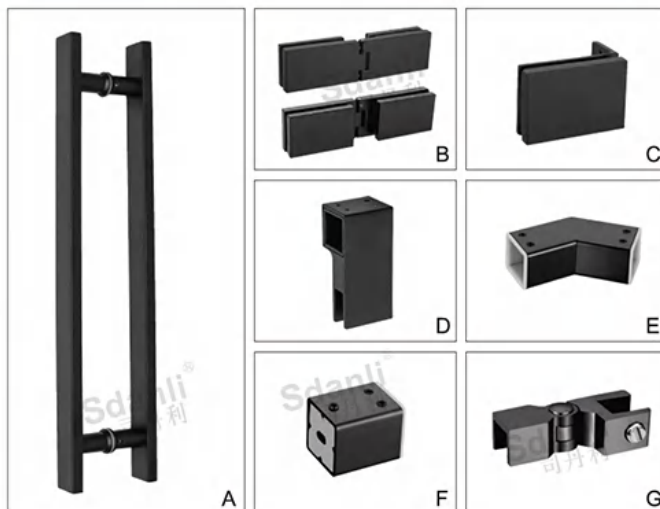

03

ESC-003

淋浴房套装
Shower room combo

- A. 拉手-1付
- B. 合页-2只
- C. 90° 角码-4只
- D. 吊夹-2只
- E. 135° 转角-2只
- F. 法兰-2只
- G. 下挡水-1套

- A. Handle-1Pair
- B. Hinge-2Pcs
- C. Connector-4Pcs
- D. Clamp-2Pcs
- E. 135° Connector-2Pcs
- F. Partition-2Pcs
- G. Clamp1Set

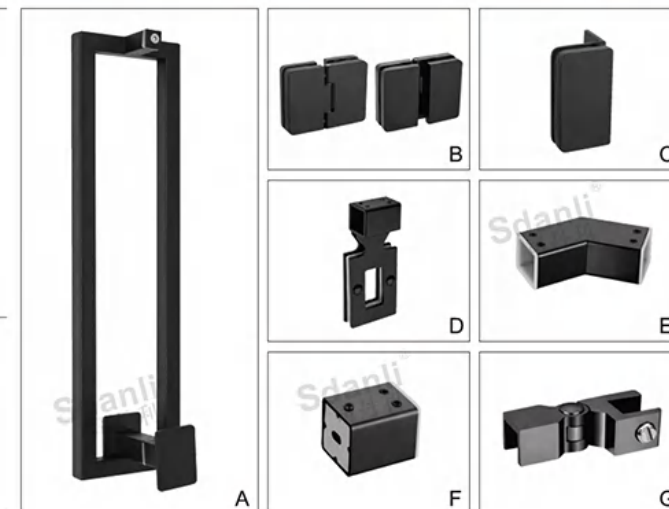

04



ESC-004

淋浴房套装
Shower room combo

- A. 拉手-1付
- B. 合页-2只
- C. 90° 角码-4只
- D. 吊夹-2只
- E. 135° 转角-2只
- F. 法兰-2只
- G. 下挡水-1套

- A. Handle-1Pair
- B. Hinge-2Pcs
- C. Connector-4Pcs
- D. Clamp-2Pcs
- E. 135° Connector-2Pcs
- F. Partition-2Pcs
- G. Clamp1Set

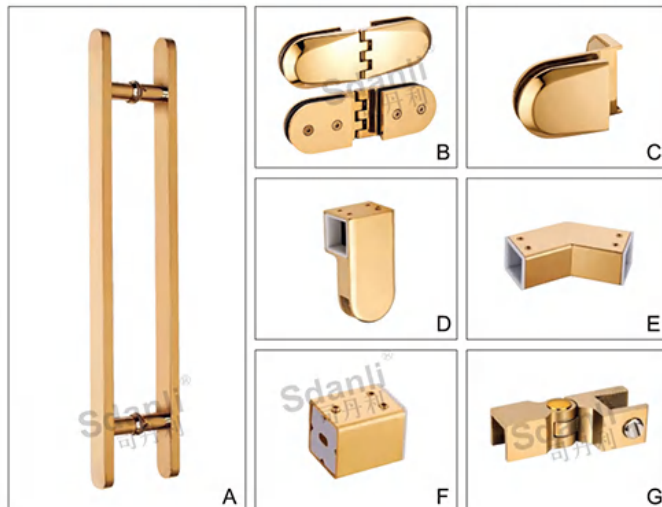

05



ESC-005

淋浴房套装
Shower room combo

- A. 拉手-1付
- B. 合页-2只
- C. 90° 角码-4只
- D. 吊夹-2只
- E. 135° 转角-2只
- F. 法兰-2只
- G. 下挡水-1套

- A. Handle-1Pair
- B. Hinge-2Pcs
- C. Connector-4Pcs
- D. Clamp-2Pcs
- E. 135° Connector-2Pcs
- F. Partition-2Pcs
- G. Clamp1Set

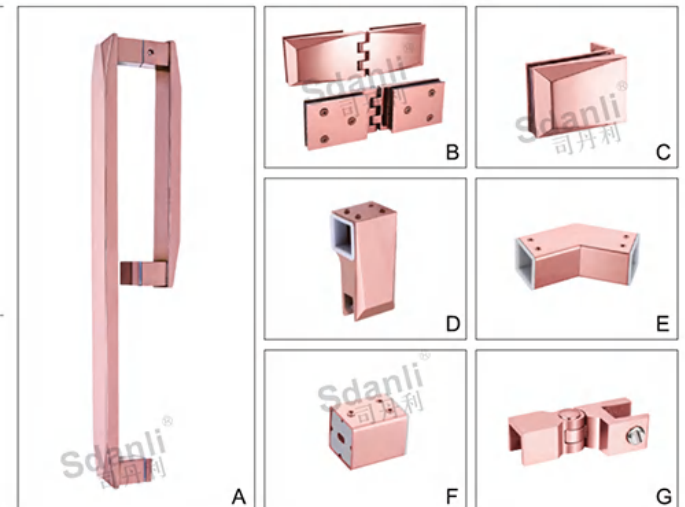

06



ESC-006

淋浴房套装
Shower room combo

- A. 拉手-1付
- B. 合页-2只
- C. 90° 角码-2只
- D. 吊夹-2只
- E. 法兰-2只
- F. 下挡水-1套

- A. Handle-1Pair
- B. Hinge-2Pcs
- C. Connector-2Pcs
- D. Clamp-2Pcs
- E. Partition-2Pcs
- F. Clamp1Set



07



ESC-007

淋浴房套装
Shower room combo

- A. 拉手-1付
- B. 合页-2只
- C. 90° 角码-4只
- D. 吊夹-2只
- E. 135° 转角-2只
- F. 法兰-2只
- G. 下挡水-1套

- A. Handle-1Pair
- B. Hinge-2Pcs
- C. Connector-4Pcs
- D. Clamp-2Pcs
- E. 135° Connector-2Pcs
- F. Partition-2Pcs
- G. Clamp1Set



08



淋浴房安装示意图 Shower room installation schematic diagram:

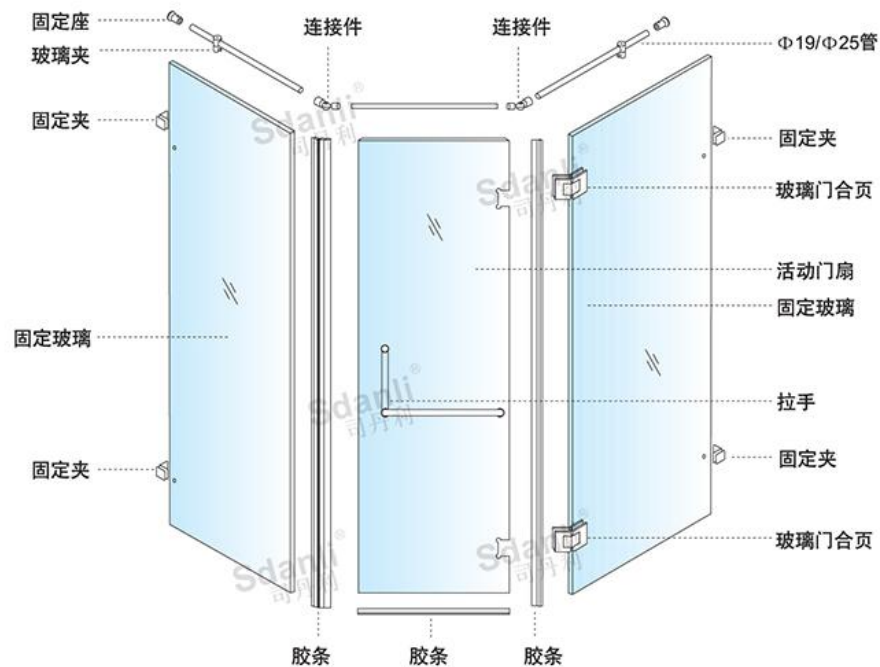

配件列表 Accessories list



玻璃门铰安装样式
Installation Guide For Glass Door Hinge

适用玻璃厚度: 8~12mm
Proper Glass Thickness: 8~12mm

适用门重: 25~50kg
proper door weight: 25~50kg

适用门宽: ≤ 900 mm
Suitable width: ≤ 900 mm

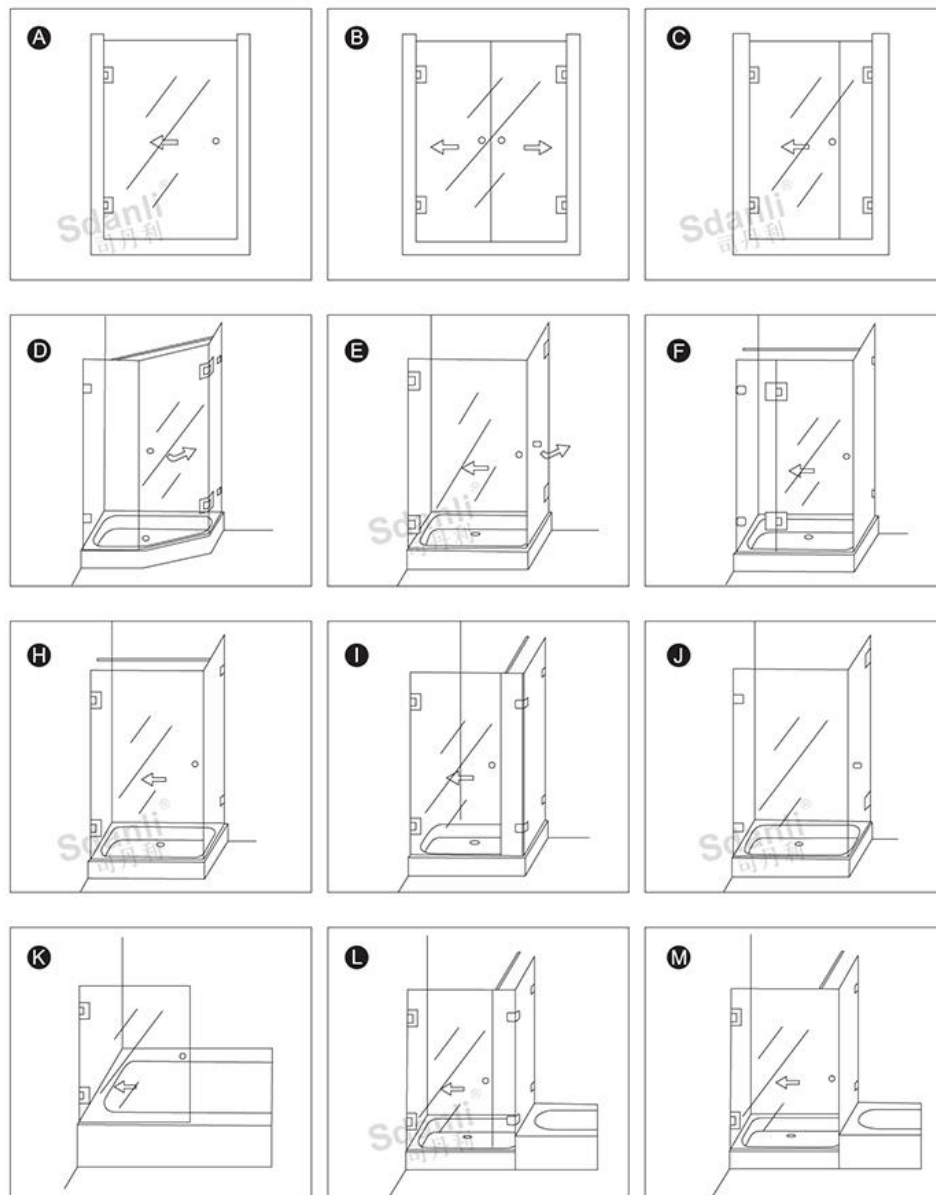



ESH-1001 圆角斜边0° 浴室夹 Fix clip 0°

适用于门宽800-1000mm,厚度8-12mm玻璃门安装
Applicable for 800-1000mm wide and 8-12mm thick glass door
注意: 玻璃必需钢化
承重: 40kg / 对
材质: 黄铜、不锈钢、锌合金
表面处理: 砂光、镀铬
Note: glass must be toughened
Bearing weight: 40kg / Pair
Material: Brass, Stainless steel, Zinc alloy
Finish: Satin Nickel, Chrome Plated

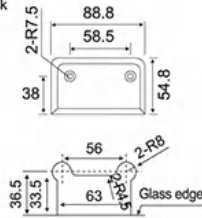

ESH-1004 圆角斜边135° 浴室夹 Glass to glass 135°

适用于门宽800-1000mm,厚度8-12mm玻璃门安装, 门关至约25° 时, 门会自关闭。
Applicable for 800-1000mm wide and 8-12mm thick glass door, Door will be close automatically at approximately 25°
注意: 玻璃必需钢化
承重: 40kg / 对
材质: 黄铜、不锈钢、锌合金
表面处理: 砂光、镀铬
Note: glass must be toughened
Bearing weight: 40kg / Pair
Material: Brass, Stainless steel, Zinc alloy
Finish: Satin Nickel, Chrome Plated

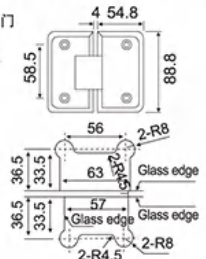

ESH-1002B 圆角斜边360° 浴室夹 360° Oblique

适用于门宽800-1000mm,厚度8-12mm玻璃门安装
Applicable for 800-1000mm wide and 8-12mm thick glass door
注意: 玻璃必需钢化
承重: 40kg / 对
材质: 黄铜、不锈钢、锌合金
表面处理: 砂光、镀铬
Note: glass must be toughened
Bearing weight: 40kg / Pair
Material: Brass, Stainless steel, Zinc alloy
Finish: Satin Nickel, Chrome Plated

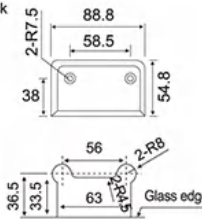

ESH-1005 圆角斜边180° 浴室夹 Glass to glass 180°

适用于门宽800-1000mm,厚度8-12mm玻璃门安装, 门关至约25° 时, 门会自关闭。
Applicable for 800-1000mm wide and 8-12mm thick glass door, Door will be close automatically at approximately 25°
注意: 玻璃必需钢化
承重: 40kg / 对
材质: 黄铜、不锈钢、锌合金
表面处理: 砂光、镀铬
Note: glass must be toughened
Bearing weight: 40kg / Pair
Material: Brass, Stainless steel, Zinc alloy
Finish: Satin Nickel, Chrome Plated

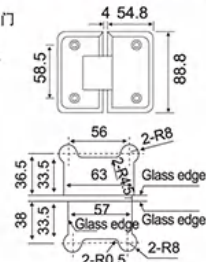

ESH-1002 圆角斜边90° 单边浴室夹 Wall to glass 90° one way

适用于门宽800-1000mm,厚度8-12mm玻璃门安装, 门关至约25° 时, 门会自关闭。
Applicable for 800-1000mm wide and 8-12mm thick glass door, Door will be close automatically at approximately 25°
注意: 玻璃必需钢化
承重: 40kg / 对
材质: 黄铜、不锈钢、锌合金
表面处理: 砂光、镀铬
Note: glass must be toughened
Bearing weight: 40kg / Pair
Material: Brass, Stainless steel, Zinc alloy
Finish: Satin Nickel, Chrome Plated

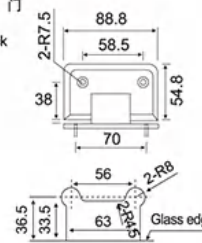

ESH-1006 圆角斜边90° 双开浴室夹 Glass to glass 90°

适用于门宽800-1000mm,厚度8-12mm玻璃门安装, 门关至约25° 时, 门会自关闭。
Applicable for 800-1000mm wide and 8-12mm thick glass door, Door will be close automatically at approximately 25°
注意: 玻璃必需钢化
承重: 40kg / 对
材质: 黄铜、不锈钢、锌合金
表面处理: 砂光、镀铬
Note: glass must be toughened
Bearing weight: 40kg / Pair
Material: Brass, Stainless steel, Zinc alloy
Finish: Satin Nickel, Chrome Plated

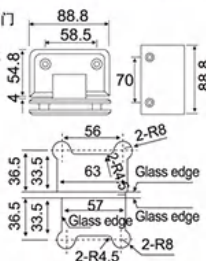

ESH-1003 圆角斜边90° 双边浴室夹 Wall to glass 90° two way

适用于门宽800-1000mm,厚度8-12mm玻璃门安装, 门关至约25° 时, 门会自关闭。
Applicable for 800-1000mm wide and 8-12mm thick glass door, Door will be close automatically at approximately 25°
注意: 玻璃必需钢化
承重: 40kg / 对
材质: 黄铜、不锈钢、锌合金
表面处理: 砂光、镀铬
Note: glass must be toughened
Bearing weight: 40kg / Pair
Material: Brass, Stainless steel, Zinc alloy
Finish: Satin Nickel, Chrome Plated

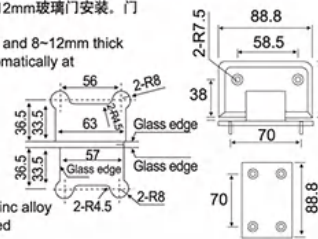

ESH-1006+ 方形斜边十字双开 Party Oblique Cross double open

适用于门宽800-1000mm,厚度8-12mm玻璃门安装, 门关至约25° 时, 门会自关闭。
Applicable for 800-1000mm wide and 8-12mm thick glass door, Door will be close automatically at approximately 25°
注意: 玻璃必需钢化
承重: 40kg / 对
材质: 黄铜、不锈钢、锌合金
表面处理: 砂光、镀铬
Note: glass must be toughened
Bearing weight: 40kg / Pair
Material: Brass, Stainless steel, Zinc alloy
Finish: Satin Nickel, Chrome Plated

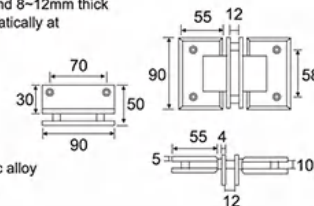



ESH-1007 直角直边0° 浴室夹 Fix clip 0°

适用于门宽800-1000mm,厚度8-12mm玻璃门安装
Applicable for 800-1000mm wide and 8-12mm thick glass door
注意: 玻璃必需钢化
承重: 40kg / 对
材质: 黄铜、不锈钢、锌合金
表面处理: 砂光、镀铬
Note: glass must be toughened
Bearing weight: 40kg / Pair
Material: Brass, Stainless steel, Zinc alloy
Finish: Satin Nickel, Chrome Plated

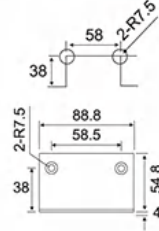

ESH-1008B 直角直边360° 浴室夹 360° Straight

适用于门宽800-1000mm,厚度8-12mm玻璃门安装
Applicable for 800-1000mm wide and 8-12mm thick glass door
注意: 玻璃必需钢化
承重: 40kg / 对
材质: 黄铜、不锈钢、锌合金
表面处理: 砂光、镀铬
Note: glass must be toughened
Bearing weight: 40kg / Pair
Material: Brass, Stainless steel, Zinc alloy
Finish: Satin Nickel, Chrome Plated

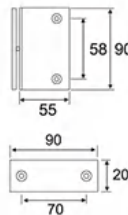

ESH-1008 直角直边90° 单边浴室夹 Wall to glass 90° one way

适用于门宽800-1000mm,厚度8-12mm玻璃门安装, 门
关至约25° 时, 门会自关闭。
Applicable for 800-1000mm wide and 8-12mm thick glass door, Door will be close automatically at approximately 25°
注意: 玻璃必需钢化
承重: 40kg / 对
材质: 黄铜、不锈钢、锌合金
表面处理: 砂光、镀铬
Note: glass must be toughened
Bearing weight: 40kg / Pair
Material: Brass, Stainless steel, Zinc alloy
Finish: Satin Nickel, Chrome Plated

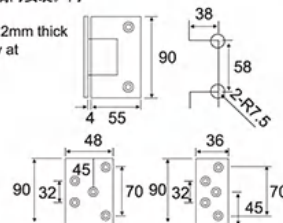

ESH-1009 直角直边90° 双边浴室夹 Wall to glass 90° two way

适用于门宽800-1000mm,厚度8-12mm玻璃门安装, 门
关至约25° 时, 门会自关闭。
Applicable for 800-1000mm wide and 8-12mm thick glass door, Door will be close automatically at approximately 25°
注意: 玻璃必需钢化
承重: 40kg / 对
材质: 黄铜、不锈钢、锌合金
表面处理: 砂光、镀铬
Note: glass must be toughened
Bearing weight: 40kg / Pair
Material: Brass, Stainless steel, Zinc alloy
Finish: Satin Nickel, Chrome Plated

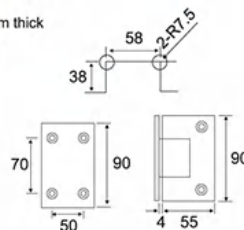

ESH-1010 直角直边135° 浴室夹 Glass to glass 135°

适用于门宽800-1000mm,厚度8-12mm玻璃门安装, 门
关至约25° 时, 门会自关闭。
Applicable for 800-1000mm wide and 8-12mm thick glass door, Door will be close automatically at approximately 25°
注意: 玻璃必需钢化
承重: 40kg / 对
材质: 黄铜、不锈钢、锌合金
表面处理: 砂光、镀铬
Note: glass must be toughened
Bearing weight: 40kg / Pair
Material: Brass, Stainless steel, Zinc alloy
Finish: Satin Nickel, Chrome Plated

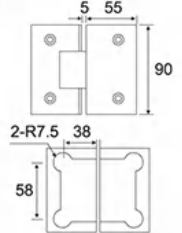

ESH-1011 直角直边180° 浴室夹 Glass to glass 180°

适用于门宽800-1000mm,厚度8-12mm玻璃门安装, 门
关至约25° 时, 门会自关闭。
Applicable for 800-1000mm wide and 8-12mm thick glass door, Door will be close automatically at approximately 25°
注意: 玻璃必需钢化
承重: 40kg / 对
材质: 黄铜、不锈钢、锌合金
表面处理: 砂光、镀铬
Note: glass must be toughened
Bearing weight: 40kg / Pair
Material: Brass, Stainless steel, Zinc alloy
Finish: Satin Nickel, Chrome Plated

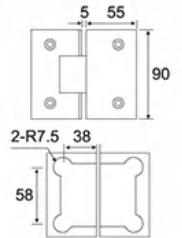

ESH-1012 直角直边90° 双开浴室夹 Glass to glass 90°

适用于门宽800-1000mm,厚度8-12mm玻璃门安装, 门
关至约25° 时, 门会自关闭。
Applicable for 800-1000mm wide and 8-12mm thick glass door, Door will be close automatically at approximately 25°
注意: 玻璃必需钢化
承重: 40kg / 对
材质: 黄铜、不锈钢、锌合金
表面处理: 砂光、镀铬
Note: glass must be toughened
Bearing weight: 40kg / Pair
Material: Brass, Stainless steel, Zinc alloy
Finish: Satin Nickel, Chrome Plated

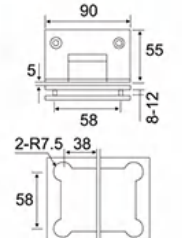

ESH-1012+ 方形直边十字双开 Straight cross double open

适用于门宽800-1000mm,厚度8-12mm玻璃门安装, 门
关至约25° 时, 门会自关闭。
Applicable for 800-1000mm wide and 8-12mm thick glass door, Door will be close automatically at approximately 25°
注意: 玻璃必需钢化
承重: 40kg / 对
材质: 黄铜、不锈钢、锌合金
表面处理: 砂光、镀铬
Note: glass must be toughened
Bearing weight: 40kg / Pair
Material: Brass, Stainless steel, Zinc alloy
Finish: Satin Nickel, Chrome Plated

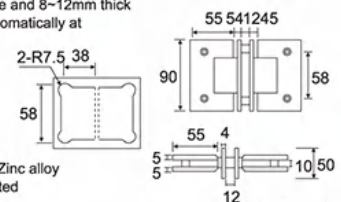

ESH-1013 直角弧面0° 浴室夹 Fix clip 0°

适用于门宽800-1000mm,厚度8-12mm玻璃门安装
Applicable for 800-1000mm wide and 8-12mm thick glass door

注意: 玻璃必需钢化

承重: 40kg / 对

材质: 黄铜、不锈钢、锌合金

表面处理: 砂光、镜光

Note: glass must be toughened

Bearing weight: 40kg / Pair

Material: Brass, Stainless steel, Zinc alloy

Finish: Satin Nickel, Chrome Plated

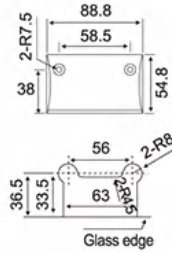

ESH-1014 直角弧面90° 单边浴室夹 Wall to glass 90° one way

适用于门宽800-1000mm,厚度8-12mm玻璃门安装。门
关至约25°时,门会自关闭。

Applicable for 800-1000mm wide and 8-12mm thick glass door. Door will be close automatically at approximately 25°

注意: 玻璃必需钢化

承重: 40kg / 对

材质: 黄铜、不锈钢、锌合金

表面处理: 砂光、镜光

Note: glass must be toughened

Bearing weight: 40kg / Pair

Material: Brass, Stainless steel, Zinc alloy

Finish: Satin Nickel, Chrome Plated

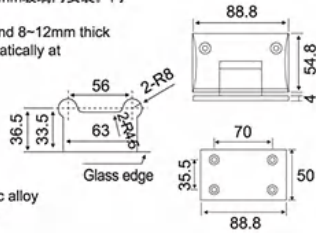

ESH-1015 直角弧面90° 双边浴室夹 Wall to glass 90° two way

适用于门宽800-1000mm,厚度8-12mm玻璃门安装。门
关至约25°时,门会自关闭。

Applicable for 800-1000mm wide and 8-12mm thick glass door. Door will be close automatically at approximately 25°

注意: 玻璃必需钢化

承重: 40kg / 对

材质: 黄铜、不锈钢、锌合金

表面处理: 砂光、镜光

Note: glass must be toughened

Bearing weight: 40kg / Pair

Material: Brass, Stainless steel, Zinc alloy

Finish: Satin Nickel, Chrome Plated

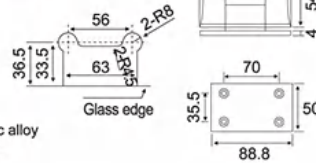

ESH-1016 直角弧面135° 浴室夹 Glass to glass 135°

适用于门宽800-1000mm,厚度8-12mm玻璃门安装。门
关至约25°时,门会自关闭。

Applicable for 800-1000mm wide and 8-12mm thick glass door. Door will be close automatically at approximately 25°

注意: 玻璃必需钢化

承重: 40kg / 对

材质: 黄铜、不锈钢、锌合金

表面处理: 砂光、镜光

Note: glass must be toughened

Bearing weight: 40kg / Pair

Material: Brass, Stainless steel, Zinc alloy

Finish: Satin Nickel, Chrome Plated

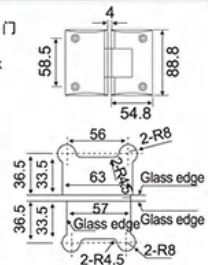

ESH-1017 直角弧面180° 浴室夹 Glass to glass 180°

适用于门宽800-1000mm,厚度8-12mm玻璃门安装。门
关至约25°时,门会自关闭。

Applicable for 800-1000mm wide and 8-12mm thick glass door. Door will be close automatically at approximately 25°

注意: 玻璃必需钢化

承重: 40kg / 对

材质: 黄铜、不锈钢、锌合金

表面处理: 砂光、镜光

Note: glass must be toughened

Bearing weight: 40kg / Pair

Material: Brass, Stainless steel, Zinc alloy

Finish: Satin Nickel, Chrome Plated

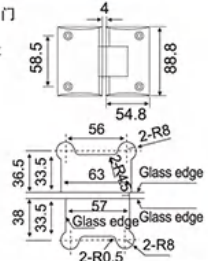

ESH-1018 直角弧面90° 双开浴室夹 Glass to glass 90°

适用于门宽800-1000mm,厚度8-12mm玻璃门安装。门
关至约25°时,门会自关闭。

Applicable for 800-1000mm wide and 8-12mm thick glass door. Door will be close automatically at approximately 25°

注意: 玻璃必需钢化

承重: 40kg / 对

材质: 黄铜、不锈钢、锌合金

表面处理: 砂光、镜光

Note: glass must be toughened

Bearing weight: 40kg / Pair

Material: Brass, Stainless steel, Zinc alloy

Finish: Satin Nickel, Chrome Plated

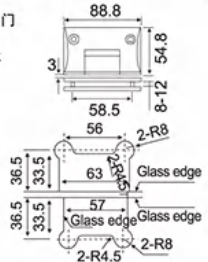

ESH-1019 圆角弧面0° 浴室夹 Fix clip 0°

适用于门宽800-1000mm,厚度8-12mm玻璃门安装
Applicable for 800-1000mm wide and 8-12mm thick glass door

注意: 玻璃必需钢化

承重: 40kg / 对

材质: 黄铜、不锈钢、锌合金

表面处理: 砂光、镜光

Note: glass must be toughened

Bearing weight: 40kg / Pair

Material: Brass, Stainless steel, Zinc alloy

Finish: Satin Nickel, Chrome Plated

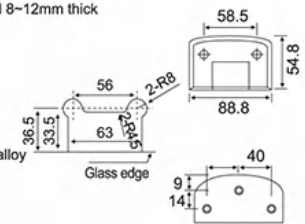

ESH-1020 圆角弧面90° 单边浴室夹 Wall to glass 90° one way

适用于门宽800-1000mm,厚度8-12mm玻璃门安装。门
关至约25°时,门会自关闭。

Applicable for 800-1000mm wide and 8-12mm thick glass door. Door will be close automatically at approximately 25°

注意: 玻璃必需钢化

承重: 40kg / 对

材质: 黄铜、不锈钢、锌合金

表面处理: 砂光、镜光

Note: glass must be toughened

Bearing weight: 40kg / Pair

Material: Brass, Stainless steel, Zinc alloy

Finish: Satin Nickel, Chrome Plated

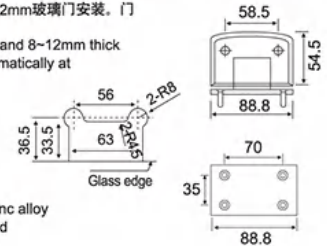

ESH-1021 圆角弧面90° 双边浴室夹 Wall to glass 90° two way



适用于门宽800-1000mm,厚度8-12mm玻璃门安装。门
关至约25° 时, 门会自关闭。
Applicable for 800-1000mm wide and 8-12mm thick
glass door, Door will be close automatically at
approximately 25°
注意: 玻璃必需钢化
承重: 40kg / 对
材质: 黄铜、不锈钢、锌合金
表面处理: 砂光、抛光
Note: glass must be toughened
Bearing weight: 40kg / Pair
Material: Brass, Stainless steel, Zinc alloy
Finish: Satin Nickel, Chrome Plated

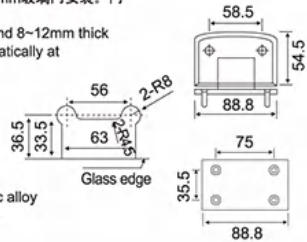

ESH-1022 圆角弧面135° 浴室夹 Glass to glass 135°



适用于门宽800-1000mm,厚度8-12mm玻璃门安装。门
关至约25° 时, 门会自关闭。
Applicable for 800-1000mm wide and 8-12mm thick
glass door, Door will be close automatically at
approximately 25°
注意: 玻璃必需钢化
承重: 40kg / 对
材质: 黄铜、不锈钢、锌合金
表面处理: 砂光、抛光
Note: glass must be toughened
Bearing weight: 40kg / Pair
Material: Brass, Stainless steel, Zinc alloy
Finish: Satin Nickel, Chrome Plated

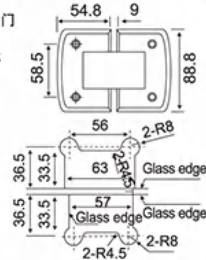

ESH-1023 圆角弧面180° 浴室夹 Glass to glass 180°



适用于门宽800-1000mm,厚度8-12mm玻璃门安装。门
关至约25° 时, 门会自关闭。
Applicable for 800-1000mm wide and 8-12mm thick
glass door, Door will be close automatically at
approximately 25°
注意: 玻璃必需钢化
承重: 40kg / 对
材质: 黄铜、不锈钢、锌合金
表面处理: 砂光、抛光
Note: glass must be toughened
Bearing weight: 40kg / Pair
Material: Brass, Stainless steel, Zinc alloy
Finish: Satin Nickel, Chrome Plated

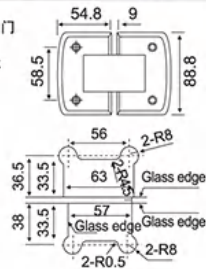

ESH-1024 圆角弧面90° 双开浴室夹 Glass to glass 90°



适用于门宽800-1000mm,厚度8-12mm玻璃门安装。门
关至约25° 时, 门会自关闭。
Applicable for 800-1000mm wide and 8-12mm thick
glass door, Door will be close automatically at
approximately 25°
注意: 玻璃必需钢化
承重: 40kg / 对
材质: 黄铜、不锈钢、锌合金
表面处理: 砂光、抛光
Note: glass must be toughened
Bearing weight: 40kg / Pair
Material: Brass, Stainless steel, Zinc alloy
Finish: Satin Nickel, Chrome Plated

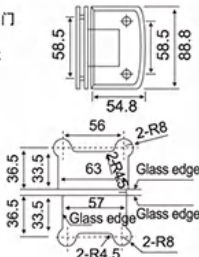

ESH-1026 90° 长夹双边 Wall to glass 90° two way



适用于门宽800-1000mm,厚度8-12mm玻璃门安装。门
关至约25° 时, 门会自关闭。
Applicable for 800-1000mm wide and 8-12mm thick
glass door, Door will be close automatically at
approximately 25°
注意: 玻璃必需钢化
承重: 45kg / 对
材质: 优质不锈钢
表面处理: 亮光、砂光
Note: glass must be toughened
Bearing weight: 45kg / Pair
Material: Quality Stainless steel
Finish: Chrome Plated, Satin Nickel

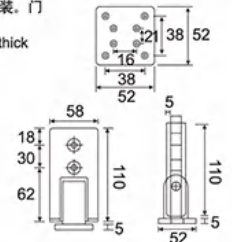

ESH-1028 180° 长夹 Glass to glass 180°



适用于门宽800-1000mm,厚度8-12mm玻璃门安装。门
关至约25° 时, 门会自关闭。
Applicable for 800-1000mm wide and 8-12mm thick
glass door, Door will be close automatically at
approximately 25°
注意: 玻璃必需钢化
承重: 45kg / 对
材质: 优质不锈钢
表面处理: 亮光、砂光
Note: glass must be toughened
Bearing weight: 45kg / Pair
Material: Quality Stainless steel
Finish: Chrome Plated, Satin Nickel

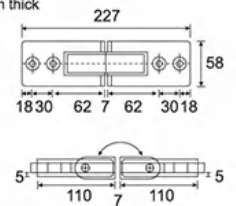

ESH-1033 90° 半圆双边 Wall to glass 90° two way



适用于门宽800-1000mm,厚度8-12mm玻璃门安装。门
关至约25° 时, 门会自关闭。
Applicable for 800-1000mm wide and 8-12mm thick
glass door, Door will be close automatically at
approximately 25°
注意: 玻璃必需钢化
承重: 45kg / 对
材质: 优质不锈钢
表面处理: 亮光、砂光
Note: glass must be toughened
Bearing weight: 45kg / Pair
Material: Quality Stainless steel
Finish: Chrome Plated, Satin Nickel

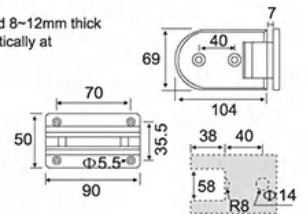

ESH-1034 180° 半圆长夹 Glass to glass 180°



适用于门宽800-1000mm,厚度8-12mm玻璃门安装。门
关至约25° 时, 门会自关闭。
Applicable for 800-1000mm wide and 8-12mm thick
glass door, Door will be close automatically at
approximately 25°
注意: 玻璃必需钢化
承重: 45kg / 对
材质: 优质不锈钢
表面处理: 亮光、砂光
Note: glass must be toughened
Bearing weight: 45kg / Pair
Material: Quality Stainless steel
Finish: Chrome Plated, Satin Nickel

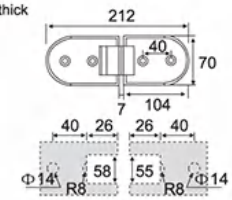

材质美学

满足现代都市向往品质生活的追求

Material aesthetics

Meet the pursuit of quality life in modern cities



ESH-1036 免开缺90° 单边 90° Need not hole cutting

适用于门宽800-1000mm,厚度8-12mm玻璃门安装。门
关至约25°时,门会自关闭。

Applicable for 800-1000mm wide and 8-12mm thick
glass door, Door will be close automatically at
approximately 25°

注意: 玻璃必需钢化

承重: 45kg / 对

材质: 优质不锈钢

表面处理: 亮光、砂光

Note: glass must be toughened

Bearing weight: 45kg / Pair

Material: Quality Stainless steel

Finish: Chrome Plated, Satin Nickel

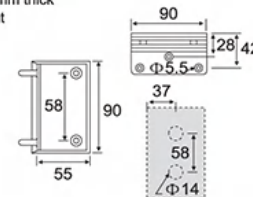

ESH-1037 免开缺90° 双边 90° Need not hole cutting

适用于门宽800-1000mm,厚度8-12mm玻璃门安装。门
关至约25°时,门会自关闭。

Applicable for 800-1000mm wide and 8-12mm thick
glass door, Door will be close automatically at
approximately 25°

注意: 玻璃必需钢化

承重: 45kg / 对

材质: 优质不锈钢

表面处理: 亮光、砂光

Note: glass must be toughened

Bearing weight: 45kg / Pair

Material: Quality Stainless steel

Finish: Chrome Plated, Satin Nickel

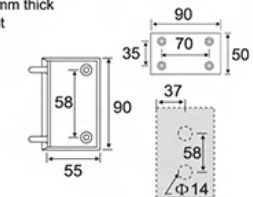

ESH-1038 免开缺135° 135° Need not hole cutting

适用于门宽800-1000mm,厚度8-12mm玻璃门安装。
注意: 玻璃必需钢化

承重: 40kg / 对

材质: 黄铜、不锈钢、锌合金

表面处理: 砂光、镜光

Note: glass must be toughened

Bearing weight: 40kg / Pair

Material: Brass, Stainless steel, Zinc alloy

Finish: Satin Nickel, Chrome Plated

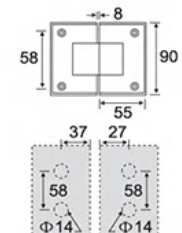

ESH-1039 免开缺180° 180° Need not hole cutting

适用于门宽800-1000mm,厚度8-12mm玻璃门安装。
注意: 玻璃必需钢化

承重: 40kg / 对

材质: 黄铜、不锈钢、锌合金

表面处理: 砂光、镜光

Note: glass must be toughened

Bearing weight: 40kg / Pair

Material: Brass, Stainless steel, Zinc alloy

Finish: Satin Nickel, Chrome Plated

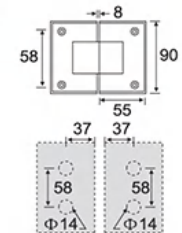



ESH-1040 90° 双边液压 Double hydraulic 90°

适用于门宽800-1000mm,厚度8-12mm玻璃门安装。门
关至约25°时,门会自关闭。
Applicable for 800-1000mm wide and 8-12mm thick
glass door, Door will be close automatically at
approximately 25°
注意: 玻璃必需钢化
承重: 45kg / 对
材质: 精铸不锈钢
表面处理: 亮光、砂光
Note: glass must be toughened
Bearing weight: 45kg / Pair
Material: Casting Stainless steel
Finish: Chrome Plated, Satin Nickel

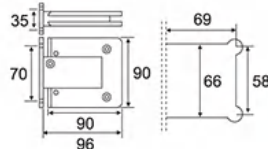

ESH-1041 180° 液压 Hydraulic 180°

适用于门宽800-1000mm,厚度8-12mm玻璃门安装。门
关至约25°时,门会自关闭。
Applicable for 800-1000mm wide and 8-12mm thick
glass door, Door will be close automatically at
approximately 25°
注意: 玻璃必需钢化
承重: 45kg / 对
材质: 精铸不锈钢
表面处理: 亮光、砂光
Note: glass must be toughened
Bearing weight: 45kg / Pair
Material: Casting Stainless steel
Finish: Chrome Plated, Satin Nickel

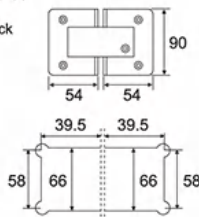

ESH-1040A 90° 双边液压 Double hydraulic 90°

适用于门宽800-1000mm,厚度8-12mm玻璃门安装。门
关至约25°时,门会自关闭。
Applicable for 800-1000mm wide and 8-12mm thick
glass door, Door will be close automatically at
approximately 25°
注意: 玻璃必需钢化
承重: 45kg / 对
材质: 精铸不锈钢
表面处理: 亮光、砂光
Note: glass must be toughened
Bearing weight: 45kg / Pair
Material: Casting Stainless steel
Finish: Chrome Plated, Satin Nickel

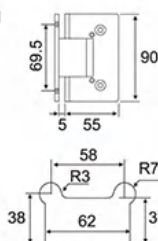

ESH-1041A 180° 液压 Hydraulic 180°

适用于门宽800-1000mm,厚度8-12mm玻璃门安装。门
关至约25°时,门会自关闭。
Applicable for 800-1000mm wide and 8-12mm thick
glass door, Door will be close automatically at
approximately 25°
注意: 玻璃必需钢化
承重: 45kg / 对
材质: 精铸不锈钢
表面处理: 亮光、砂光
Note: glass must be toughened
Bearing weight: 45kg / Pair
Material: Casting Stainless steel
Finish: Chrome Plated, Satin Nickel

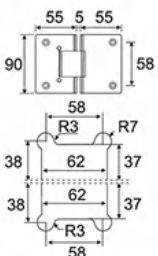

ESH-1042 内外开90° Inside and outside 90°

适用于门宽800-1000mm,厚度8-12mm玻璃门安装。
Applicable for 800-1000mm wide and 8-12mm thick
注意: 玻璃必需钢化
承重: 40kg / 对
材质: 黄铜、不锈钢、锌合金
表面处理: 砂光、镜光
Note: glass must be toughened
Bearing weight: 40kg / Pair
Material: Brass, Stainless steel, Zinc alloy
Finish: Satin Nickel, Chrome Plated

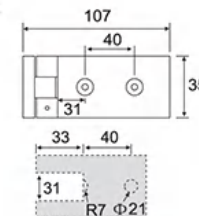

ESH-1043 内外开180° Inside and outside 180°

适用于门宽800-1000mm,厚度8-12mm玻璃门安装。
Applicable for 800-1000mm wide and 8-12mm thick
注意: 玻璃必需钢化
承重: 40kg / 对
材质: 黄铜、不锈钢、锌合金
表面处理: 砂光、镜光
Note: glass must be toughened
Bearing weight: 40kg / Pair
Material: Brass, Stainless steel, Zinc alloy
Finish: Satin Nickel, Chrome Plated

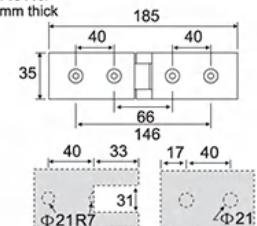

ESH-1044 内外开135° Inside and outside 135°

适用于门宽800-1000mm,厚度8-12mm玻璃门安装。
Applicable for 800-1000mm wide and 8-12mm thick
注意: 玻璃必需钢化
承重: 40kg / 对
材质: 黄铜、不锈钢、锌合金
表面处理: 砂光、镜光
Note: glass must be toughened
Bearing weight: 40kg / Pair
Material: Brass, Stainless steel, Zinc alloy
Finish: Satin Nickel, Chrome Plated

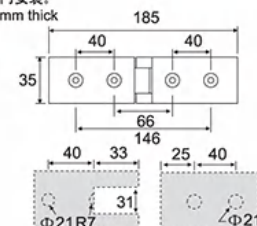

ESH-1045 外开单边 Outer opening single-sided

适用于门宽800-1000mm,厚度8-12mm玻璃门安装。
Applicable for 800-1000mm wide and 8-12mm thick
注意: 玻璃必需钢化
承重: 40kg / 对
材质: 黄铜、不锈钢、锌合金
表面处理: 砂光、镜光
Note: glass must be toughened
Bearing weight: 40kg / Pair
Material: Brass, Stainless steel, Zinc alloy
Finish: Satin Nickel, Chrome Plated

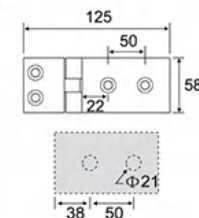



ESH-1046 外开双边 Outward opening bilateral

适用于门宽800-1000mm,厚度8-12mm玻璃门安装。
Applicable for 800-1000mm wide and 8-12mm thick
注意: 玻璃必需钢化
承重: 40kg / 对
材质: 黄铜、不锈钢、锌合金
表面处理: 砂光、镜光
Note: glass must be toughened
Bearing weight: 40kg / Pair
Material: Brass, Stainless steel, Zinc alloy
Finish: Satin Nickel, Chrome Plated

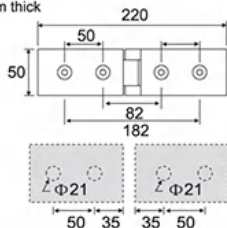

ESH-1050 圆角外开单边 Rounded corners outer opening single-sided

适用于门宽800-1000mm,厚度8-12mm玻璃门安装。
Applicable for 800-1000mm wide and 8-12mm thick
注意: 玻璃必需钢化
承重: 40kg / 对
材质: 黄铜、不锈钢、锌合金
表面处理: 砂光、镜光
Note: glass must be toughened
Bearing weight: 40kg / Pair
Material: Brass, Stainless steel, Zinc alloy
Finish: Satin Nickel, Chrome Plated

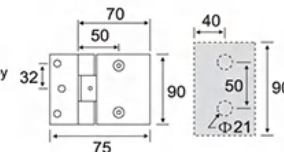

ESH-1047 长圆外开双边 Long round outward opening bilateral

适用于门宽800-1000mm,厚度8-12mm玻璃门安装。
Applicable for 800-1000mm wide and 8-12mm thick
注意: 玻璃必需钢化
承重: 40kg / 对
材质: 黄铜、不锈钢、锌合金
表面处理: 砂光、镜光
Note: glass must be toughened
Bearing weight: 40kg / Pair
Material: Brass, Stainless steel, Zinc alloy
Finish: Satin Nickel, Chrome Plated

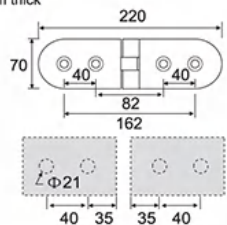

ESH-1051 圆角外开双边 Rounded corners outer opening bilateral

适用于门宽800-1000mm,厚度8-12mm玻璃门安装。
Applicable for 800-1000mm wide and 8-12mm thick
注意: 玻璃必需钢化
承重: 40kg / 对
材质: 黄铜、不锈钢、锌合金
表面处理: 砂光、镜光
Note: glass must be toughened
Bearing weight: 40kg / Pair
Material: Brass, Stainless steel, Zinc alloy
Finish: Satin Nickel, Chrome Plated

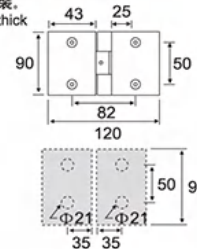

ESH-1048 45# 圆角外开单边 45# Rounded corners outer opening single-sided

适用于门宽800-1000mm,厚度8-12mm玻璃门安装。
Applicable for 800-1000mm wide and 8-12mm thick
注意: 玻璃必需钢化
承重: 40kg / 对
材质: 黄铜、不锈钢、锌合金
表面处理: 砂光、镜光
Note: glass must be toughened
Bearing weight: 40kg / Pair
Material: Brass, Stainless steel, Zinc alloy
Finish: Satin Nickel, Chrome Plated

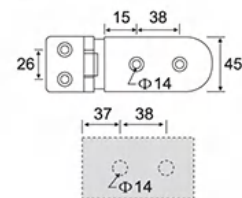

ESH-1052 90# 外开单边 90# Outer opening single-sided

适用于门宽800-1000mm,厚度8-12mm玻璃门安装。
Applicable for 800-1000mm wide and 8-12mm thick
注意: 玻璃必需钢化
承重: 40kg / 对
材质: 黄铜、不锈钢、锌合金
表面处理: 砂光、镜光
Note: glass must be toughened
Bearing weight: 40kg / Pair
Material: Brass, Stainless steel, Zinc alloy
Finish: Satin Nickel, Chrome Plated

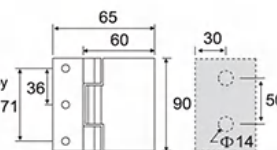

ESH-1049 45# 圆角外开双边 45# Rounded corners outer opening bilateral

适用于门宽800-1000mm,厚度8-12mm玻璃门安装。
Applicable for 800-1000mm wide and 8-12mm thick
注意: 玻璃必需钢化
承重: 40kg / 对
材质: 黄铜、不锈钢、锌合金
表面处理: 砂光、镜光
Note: glass must be toughened
Bearing weight: 40kg / Pair
Material: Brass, Stainless steel, Zinc alloy
Finish: Satin Nickel, Chrome Plated

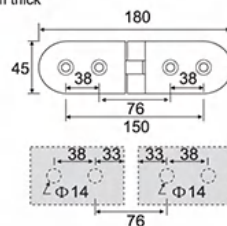

ESH-1053 90# 外开双边 90# Outer opening bilateral

适用于门宽800-1000mm,厚度8-12mm玻璃门安装。
Applicable for 800-1000mm wide and 8-12mm thick
注意: 玻璃必需钢化
承重: 40kg / 对
材质: 黄铜、不锈钢、锌合金
表面处理: 砂光、镜光
Note: glass must be toughened
Bearing weight: 40kg / Pair
Material: Brass, Stainless steel, Zinc alloy
Finish: Satin Nickel, Chrome Plated

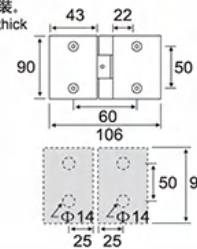



ESH-1054 90# 斜边内开单边 90# Inside opening single-sided

适用于门宽800-1000mm,厚度8-12mm玻璃门安装。
Applicable for 800-1000mm wide and 8-12mm thick
注意: 玻璃必需钢化
承重: 40kg / 对
材质: 黄铜、不锈钢、锌合金
表面处理: 砂光、镜光
Note: glass must be toughened
Bearing weight: 40kg / Pair
Material: Brass, Stainless steel, Zinc alloy
Finish: Satin Nickel, Chrome Plated

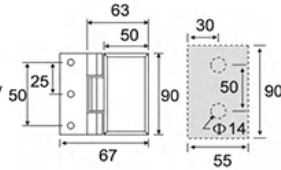

ESH-1055 90# 斜边内开双边 90# Inside opening bilateral

适用于门宽800-1000mm,厚度8-12mm玻璃门安装。
Applicable for 800-1000mm wide and 8-12mm thick
注意: 玻璃必需钢化
承重: 40kg / 对
材质: 黄铜、不锈钢、锌合金
表面处理: 砂光、镜光
Note: glass must be toughened
Bearing weight: 40kg / Pair
Material: Brass, Stainless steel, Zinc alloy
Finish: Satin Nickel, Chrome Plated

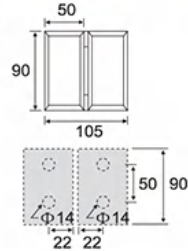

ESH-1056 90# 内开弧面单边 90# Inside opening single-sided

适用于门宽800-1000mm,厚度8-12mm玻璃门安装。
Applicable for 800-1000mm wide and 8-12mm thick
注意: 玻璃必需钢化
承重: 40kg / 对
材质: 黄铜、不锈钢、锌合金
表面处理: 砂光、镜光
Note: glass must be toughened
Bearing weight: 40kg / Pair
Material: Brass, Stainless steel, Zinc alloy
Finish: Satin Nickel, Chrome Plated

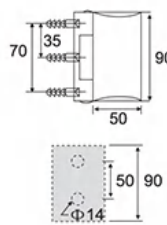

ESH-1057 90# 内开弧面双边 90# Outer opening bilateral

适用于门宽800-1000mm,厚度8-12mm玻璃门安装。
Applicable for 800-1000mm wide and 8-12mm thick
注意: 玻璃必需钢化
承重: 40kg / 对
材质: 黄铜、不锈钢、锌合金
表面处理: 砂光、镜光
Note: glass must be toughened
Bearing weight: 40kg / Pair
Material: Brass, Stainless steel, Zinc alloy
Finish: Satin Nickel, Chrome Plated

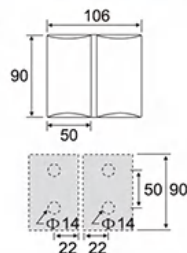

ESH-1058 70# 内开双边 70# Inside opening bilateral

适用于门宽800-1000mm,厚度8-12mm玻璃门安装。
Applicable for 800-1000mm wide and 8-12mm thick
注意: 玻璃必需钢化
承重: 40kg / 对
材质: 黄铜、不锈钢、锌合金
表面处理: 砂光、镜光
Note: glass must be toughened
Bearing weight: 40kg / Pair
Material: Brass, Stainless steel, Zinc alloy
Finish: Satin Nickel, Chrome Plated

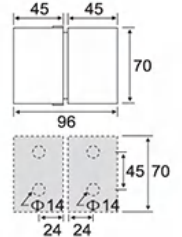

ESH-1059 70# 外开双边 70# Outer opening bilateral

适用于门宽800-1000mm,厚度8-12mm玻璃门安装。
Applicable for 800-1000mm wide and 8-12mm thick
注意: 玻璃必需钢化
承重: 40kg / 对
材质: 黄铜、不锈钢、锌合金
表面处理: 砂光、镜光
Note: glass must be toughened
Bearing weight: 40kg / Pair
Material: Brass, Stainless steel, Zinc alloy
Finish: Satin Nickel, Chrome Plated

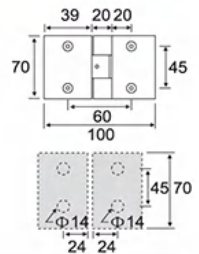

ESH-1060 斜面外开单边 Outside opening single-sided

适用于门宽800-1000mm,厚度8-12mm玻璃门安装。
Applicable for 800-1000mm wide and 8-12mm thick
注意: 玻璃必需钢化
承重: 40kg / 对
材质: 黄铜、不锈钢、锌合金
表面处理: 砂光、镜光
Note: glass must be toughened
Bearing weight: 40kg / Pair
Material: Brass, Stainless steel, Zinc alloy
Finish: Satin Nickel, Chrome Plated

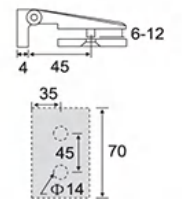

ESH-1061 斜面外开双边 Outside opening bilateral

适用于门宽800-1000mm,厚度8-12mm玻璃门安装。
Applicable for 800-1000mm wide and 8-12mm thick
注意: 玻璃必需钢化
承重: 40kg / 对
材质: 黄铜、不锈钢、锌合金
表面处理: 砂光、镜光
Note: glass must be toughened
Bearing weight: 40kg / Pair
Material: Brass, Stainless steel, Zinc alloy
Finish: Satin Nickel, Chrome Plated

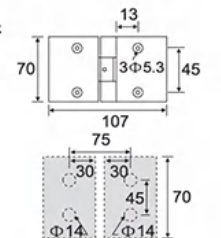



ESH-1062 70# 内开单边 70# Inside opening single

适用于门宽800-1000mm,厚度8-12mm玻璃门安装。
Applicable for 800-1000mm wide and 8-12mm thick
注意: 玻璃必需钢化
承重: 40kg / 对
材质: 黄铜、不锈钢、锌合金
表面处理: 砂光、镜光
Note: glass must be toughened
Bearing weight: 40kg / Pair
Material: Brass, Stainless steel, Zinc alloy
Finish: Satin Nickel, Chrome Plated

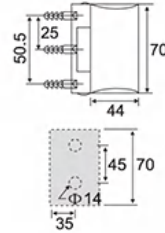

ESH-1066 菱形外开单边 Outer opening single-sided

适用于门宽800-1000mm,厚度8-12mm玻璃门安装。
Applicable for 800-1000mm wide and 8-12mm thick
注意: 玻璃必需钢化
承重: 40kg / 对
材质: 黄铜、不锈钢、锌合金
表面处理: 砂光、镜光
Note: glass must be toughened
Bearing weight: 40kg / Pair
Material: Brass, Stainless steel, Zinc alloy
Finish: Satin Nickel, Chrome Plated

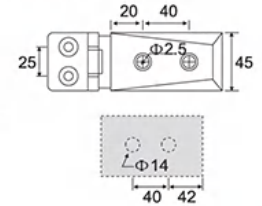

ESH-1063 70# 外开双边 70# Outer opening bilateral

适用于门宽800-1000mm,厚度8-12mm玻璃门安装。
Applicable for 800-1000mm wide and 8-12mm thick
注意: 玻璃必需钢化
承重: 40kg / 对
材质: 黄铜、不锈钢、锌合金
表面处理: 砂光、镜光
Note: glass must be toughened
Bearing weight: 40kg / Pair
Material: Brass, Stainless steel, Zinc alloy
Finish: Satin Nickel, Chrome Plated

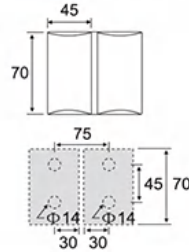

ESH-1067 菱形外开双边 Outer opening bilateral

适用于门宽800-1000mm,厚度8-12mm玻璃门安装。
Applicable for 800-1000mm wide and 8-12mm thick
注意: 玻璃必需钢化
承重: 40kg / 对
材质: 黄铜、不锈钢、锌合金
表面处理: 砂光、镜光
Note: glass must be toughened
Bearing weight: 40kg / Pair
Material: Brass, Stainless steel, Zinc alloy
Finish: Satin Nickel, Chrome Plated

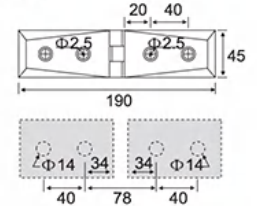

ESH-1064 70# 弧面外开单边 70# Outer opening single-sided

适用于门宽800-1000mm,厚度8-12mm玻璃门安装。
Applicable for 800-1000mm wide and 8-12mm thick
注意: 玻璃必需钢化
承重: 40kg / 对
材质: 黄铜、不锈钢、锌合金
表面处理: 砂光、镜光
Note: glass must be toughened
Bearing weight: 40kg / Pair
Material: Brass, Stainless steel, Zinc alloy
Finish: Satin Nickel, Chrome Plated

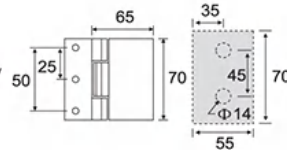

ESH-1068 弧面外开单边 Outer opening single-sided

适用于门宽800-1000mm,厚度8-12mm玻璃门安装。
Applicable for 800-1000mm wide and 8-12mm thick
注意: 玻璃必需钢化
承重: 40kg / 对
材质: 黄铜、不锈钢、锌合金
表面处理: 砂光、镜光
Note: glass must be toughened
Bearing weight: 40kg / Pair
Material: Brass, Stainless steel, Zinc alloy
Finish: Satin Nickel, Chrome Plated

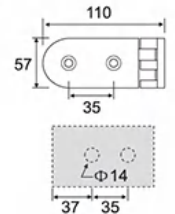

ESH-1065 70# 弧面外开双边 70# Outer opening bilateral

适用于门宽800-1000mm,厚度8-12mm玻璃门安装。
Applicable for 800-1000mm wide and 8-12mm thick
注意: 玻璃必需钢化
承重: 40kg / 对
材质: 黄铜、不锈钢、锌合金
表面处理: 砂光、镜光
Note: glass must be toughened
Bearing weight: 40kg / Pair
Material: Brass, Stainless steel, Zinc alloy
Finish: Satin Nickel, Chrome Plated

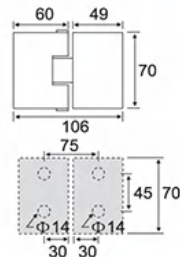

ESH-1069 弧面外开双边 Outer opening bilateral

适用于门宽800-1000mm,厚度8-12mm玻璃门安装。
Applicable for 800-1000mm wide and 8-12mm thick
注意: 玻璃必需钢化
承重: 40kg / 对
材质: 黄铜、不锈钢、锌合金
表面处理: 砂光、镜光
Note: glass must be toughened
Bearing weight: 40kg / Pair
Material: Brass, Stainless steel, Zinc alloy
Finish: Satin Nickel, Chrome Plated

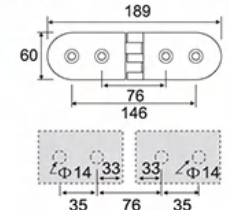



ESH-1070 圆边外开单边 Outer opening single-sided

适用于门宽800-1000mm,厚度8-12mm玻璃门安装。
Applicable for 800-1000mm wide and 8-12mm thick
注意: 玻璃必需钢化
承重: 40kg / 对
材质: 黄铜、不锈钢、锌合金
表面处理: 砂光、镜光
Note: glass must be toughened
Bearing weight: 40kg / Pair
Material: Brass, Stainless steel, Zinc alloy
Finish: Satin Nickel, Chrome Plated

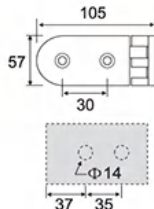

ESH-1074 45# 弧面外开单边 45# Outer opening single-sided

适用于门宽800-1000mm,厚度8-12mm玻璃门安装。
Applicable for 800-1000mm wide and 8-12mm thick
注意: 玻璃必需钢化
承重: 40kg / 对
材质: 黄铜、不锈钢、锌合金
表面处理: 砂光、镜光
Note: glass must be toughened
Bearing weight: 40kg / Pair
Material: Brass, Stainless steel, Zinc alloy
Finish: Satin Nickel, Chrome Plated

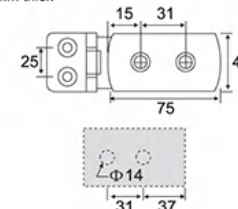

ESH-1071 弧边外开双边 Outer opening bilateral

适用于门宽800-1000mm,厚度8-12mm玻璃门安装。
Applicable for 800-1000mm wide and 8-12mm thick
注意: 玻璃必需钢化
承重: 40kg / 对
材质: 黄铜、不锈钢、锌合金
表面处理: 砂光、镜光
Note: glass must be toughened
Bearing weight: 40kg / Pair
Material: Brass, Stainless steel, Zinc alloy
Finish: Satin Nickel, Chrome Plated

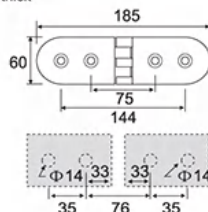

ESH-1075 45# 弧面外开双边 45# Outer opening bilateral

适用于门宽800-1000mm,厚度8-12mm玻璃门安装。
Applicable for 800-1000mm wide and 8-12mm thick
注意: 玻璃必需钢化
承重: 40kg / 对
材质: 黄铜、不锈钢、锌合金
表面处理: 砂光、镜光
Note: glass must be toughened
Bearing weight: 40kg / Pair
Material: Brass, Stainless steel, Zinc alloy
Finish: Satin Nickel, Chrome Plated

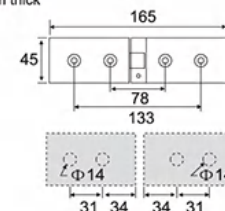

ESH-1072 钝角外开单边 Obtuse Angle Outer opening sided

适用于门宽800-1000mm,厚度8-12mm玻璃门安装。
Applicable for 800-1000mm wide and 8-12mm thick
注意: 玻璃必需钢化
承重: 40kg / 对
材质: 黄铜、不锈钢、锌合金
表面处理: 砂光、镜光
Note: glass must be toughened
Bearing weight: 40kg / Pair
Material: Brass, Stainless steel, Zinc alloy
Finish: Satin Nickel, Chrome Plated

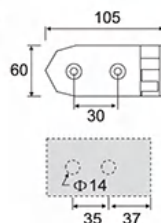

ESH-1076 45# 弧面外开单边 45# Outer opening single-sided

适用于门宽800-1000mm,厚度8-12mm玻璃门安装。
Applicable for 800-1000mm wide and 8-12mm thick
注意: 玻璃必需钢化
承重: 40kg / 对
材质: 黄铜、不锈钢、锌合金
表面处理: 砂光、镜光
Note: glass must be toughened
Bearing weight: 40kg / Pair
Material: Brass, Stainless steel, Zinc alloy
Finish: Satin Nickel, Chrome Plated

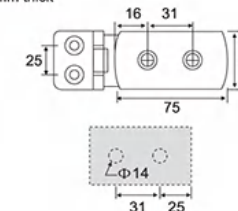

ESH-1073 钝角外开双边 Obtuse Angle Outer opening Double

适用于门宽800-1000mm,厚度8-12mm玻璃门安装。
Applicable for 800-1000mm wide and 8-12mm thick
注意: 玻璃必需钢化
承重: 40kg / 对
材质: 黄铜、不锈钢、锌合金
表面处理: 砂光、镜光
Note: glass must be toughened
Bearing weight: 40kg / Pair
Material: Brass, Stainless steel, Zinc alloy
Finish: Satin Nickel, Chrome Plated

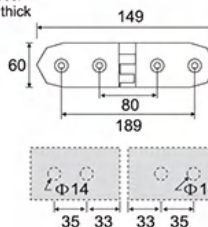

ESH-1077 45# 平面外开单边 45# Out-of plane single-sided

适用于门宽800-1000mm,厚度8-12mm玻璃门安装。
Applicable for 800-1000mm wide and 8-12mm thick
注意: 玻璃必需钢化
承重: 40kg / 对
材质: 黄铜、不锈钢、锌合金
表面处理: 砂光、镜光
Note: glass must be toughened
Bearing weight: 40kg / Pair
Material: Brass, Stainless steel, Zinc alloy
Finish: Satin Nickel, Chrome Plated

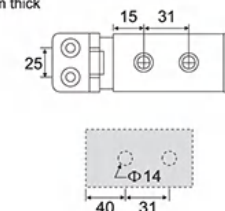



ESH-1078 45# 平面直角外开单边 45# Out-of plane single-sided

适用于门宽800-1000mm,厚度8-12mm玻璃门安装。
Applicable for 800-1000mm wide and 8-12mm thick
注意: 玻璃必需钢化
承重: 40kg / 对
材质: 黄铜、不锈钢、锌合金
表面处理: 砂光、镜光
Note: glass must be toughened
Bearing weight: 40kg / Pair
Material: Brass, Stainless steel, Zinc alloy
Finish: Satin Nickel, Chrome Plated

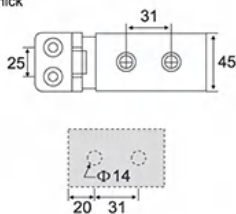

ESH-1079 45# 平面外开双边 45# Out-of plane bilateral

适用于门宽800-1000mm,厚度8-12mm玻璃门安装。
Applicable for 800-1000mm wide and 8-12mm thick
注意: 玻璃必需钢化
承重: 40kg / 对
材质: 黄铜、不锈钢、锌合金
表面处理: 砂光、镜光
Note: glass must be toughened
Bearing weight: 40kg / Pair
Material: Brass, Stainless steel, Zinc alloy
Finish: Satin Nickel, Chrome Plated

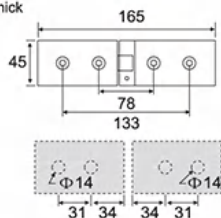

ESH-1080 圆珠单边 Round bead single-sided

适用于门宽800-1000mm,厚度8-12mm玻璃门安装。
Applicable for 800-1000mm wide and 8-12mm thick
注意: 玻璃必需钢化
承重: 40kg / 对
材质: 黄铜、不锈钢、锌合金
表面处理: 砂光、镜光
Note: glass must be toughened
Bearing weight: 40kg / Pair
Material: Brass, Stainless steel, Zinc alloy
Finish: Satin Nickel, Chrome Plated

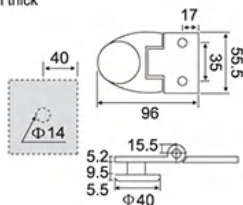

ESH-1081 圆珠双边 Round bead bilateral

适用于门宽800-1000mm,厚度8-12mm玻璃门安装。
Applicable for 800-1000mm wide and 8-12mm thick
注意: 玻璃必需钢化
承重: 40kg / 对
材质: 黄铜、不锈钢、锌合金
表面处理: 砂光、镜光
Note: glass must be toughened
Bearing weight: 40kg / Pair
Material: Brass, Stainless steel, Zinc alloy
Finish: Satin Nickel, Chrome Plated

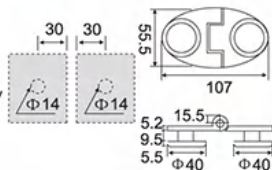

ESH-1082 圆珠单边 Round bead single-sided

适用于门宽800-1000mm,厚度8-12mm玻璃门安装。
Applicable for 800-1000mm wide and 8-12mm thick
注意: 玻璃必需钢化
承重: 40kg / 对
材质: 黄铜、不锈钢、锌合金
表面处理: 砂光、镜光
Note: glass must be toughened
Bearing weight: 40kg / Pair
Material: Brass, Stainless steel, Zinc alloy
Finish: Satin Nickel, Chrome Plated

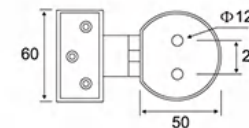

ESH-1083 圆珠双边 Round bead bilateral

适用于门宽800-1000mm,厚度8-12mm玻璃门安装。
Applicable for 800-1000mm wide and 8-12mm thick
注意: 玻璃必需钢化
承重: 40kg / 对
材质: 黄铜、不锈钢、锌合金
表面处理: 砂光、镜光
Note: glass must be toughened
Bearing weight: 40kg / Pair
Material: Brass, Stainless steel, Zinc alloy
Finish: Satin Nickel, Chrome Plated

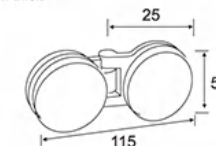

ESH-1084 圆边形角码 Round corner code

适用于门宽800-1000mm,厚度8-12mm玻璃门安装。
Applicable for 800-1000mm wide and 8-12mm thick
注意: 玻璃必需钢化
承重: 40kg / 对
材质: 黄铜、不锈钢、锌合金
表面处理: 砂光、镜光
Note: glass must be toughened
Bearing weight: 40kg / Pair
Material: Brass, Stainless steel, Zinc alloy
Finish: Satin Nickel, Chrome Plated

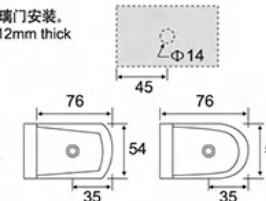

ESH-1085 长圆角形角码 Long rounded corner code

适用于门宽800-1000mm,厚度8-12mm玻璃门安装。
Applicable for 800-1000mm wide and 8-12mm thick
注意: 玻璃必需钢化
承重: 40kg / 对
材质: 黄铜、不锈钢、锌合金
表面处理: 砂光、镜光
Note: glass must be toughened
Bearing weight: 40kg / Pair
Material: Brass, Stainless steel, Zinc alloy
Finish: Satin Nickel, Chrome Plated

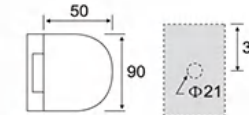

ESH-1086 蝴蝶形角码 Butterfly-shaped corner code

适用于门宽800-1000mm,厚度8-12mm玻璃门安装。
Applicable for 800-1000mm wide and 8-12mm thick
注意: 玻璃必需钢化
承重: 40kg / 对
材质: 黄铜、不锈钢、锌合金
表面处理: 砂光、镜光
Note: glass must be toughened
Bearing weight: 40kg / Pair
Material: Brass, Stainless steel, Zinc alloy
Finish: Satin Nickel, Chrome Plated

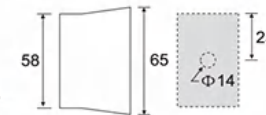



ESH-1089 斜边单边 Oblique single-sided

适用于门宽800-1000mm,厚度8-12mm玻璃门安装。
Applicable for 800-1000mm wide and 8-12mm thick
注意: 玻璃必需钢化
承重: 40kg / 对
材质: 黄铜、不锈钢、锌合金
表面处理: 砂光、镜光
Note: glass must be toughened
Bearing weight: 40kg / Pair
Material: Brass, Stainless steel, Zinc alloy
Finish: Satin Nickel, Chrome Plated

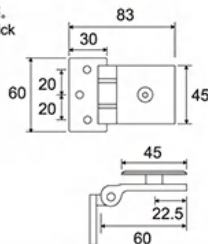

ESH-1093 直边单边 Straight single-sided

适用于门宽800-1000mm,厚度8-12mm玻璃门安装。
Applicable for 800-1000mm wide and 8-12mm thick
注意: 玻璃必需钢化
承重: 40kg / 对
材质: 黄铜、不锈钢、锌合金
表面处理: 砂光、镜光
Note: glass must be toughened
Bearing weight: 40kg / Pair
Material: Brass, Stainless steel, Zinc alloy
Finish: Satin Nickel, Chrome Plated

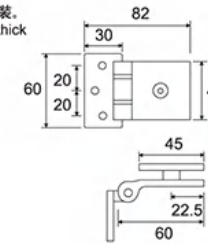

ESH-1090 斜边双边 Oblique bilateral

适用于门宽800-1000mm,厚度8-12mm玻璃门安装。
Applicable for 800-1000mm wide and 8-12mm thick
注意: 玻璃必需钢化
承重: 40kg / 对
材质: 黄铜、不锈钢、锌合金
表面处理: 砂光、镜光
Note: glass must be toughened
Bearing weight: 40kg / Pair
Material: Brass, Stainless steel, Zinc alloy
Finish: Satin Nickel, Chrome Plated

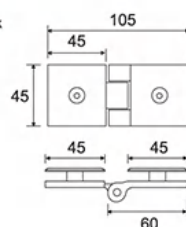

ESH-1094 直边双边 Straight bilateral

适用于门宽800-1000mm,厚度8-12mm玻璃门安装。
Applicable for 800-1000mm wide and 8-12mm thick
注意: 玻璃必需钢化
承重: 40kg / 对
材质: 黄铜、不锈钢、锌合金
表面处理: 砂光、镜光
Note: glass must be toughened
Bearing weight: 40kg / Pair
Material: Brass, Stainless steel, Zinc alloy
Finish: Satin Nickel, Chrome Plated

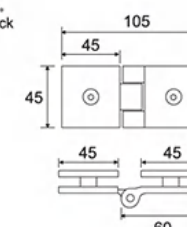

ESH-1091 弧面单边 Camber single-sided

适用于门宽800-1000mm,厚度8-12mm玻璃门安装。
Applicable for 800-1000mm wide and 8-12mm thick
注意: 玻璃必需钢化
承重: 40kg / 对
材质: 黄铜、不锈钢、锌合金
表面处理: 砂光、镜光
Note: glass must be toughened
Bearing weight: 40kg / Pair
Material: Brass, Stainless steel, Zinc alloy
Finish: Satin Nickel, Chrome Plated

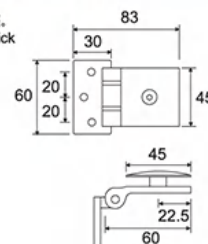

ESH-1095 圆珠单边 Round bead single-sided

适用于门宽800-1000mm,厚度8-12mm玻璃门安装。
Applicable for 800-1000mm wide and 8-12mm thick
注意: 玻璃必需钢化
承重: 40kg / 对
材质: 黄铜、不锈钢、锌合金
表面处理: 砂光、镜光
Note: glass must be toughened
Bearing weight: 40kg / Pair
Material: Brass, Stainless steel, Zinc alloy
Finish: Satin Nickel, Chrome Plated

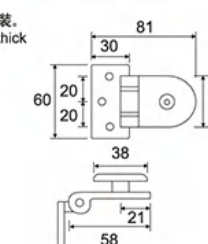

ESH-1092 弧面双边 Camber bilateral

适用于门宽800-1000mm,厚度8-12mm玻璃门安装。
Applicable for 800-1000mm wide and 8-12mm thick
注意: 玻璃必需钢化
承重: 40kg / 对
材质: 黄铜、不锈钢、锌合金
表面处理: 砂光、镜光
Note: glass must be toughened
Bearing weight: 40kg / Pair
Material: Brass, Stainless steel, Zinc alloy
Finish: Satin Nickel, Chrome Plated

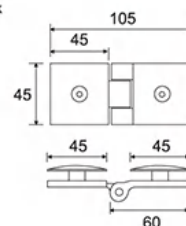

ESH-1096 圆珠双边 Round bead bilateral

适用于门宽800-1000mm,厚度8-12mm玻璃门安装。
Applicable for 800-1000mm wide and 8-12mm thick
注意: 玻璃必需钢化
承重: 40kg / 对
材质: 黄铜、不锈钢、锌合金
表面处理: 砂光、镜光
Note: glass must be toughened
Bearing weight: 40kg / Pair
Material: Brass, Stainless steel, Zinc alloy
Finish: Satin Nickel, Chrome Plated

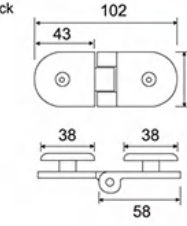

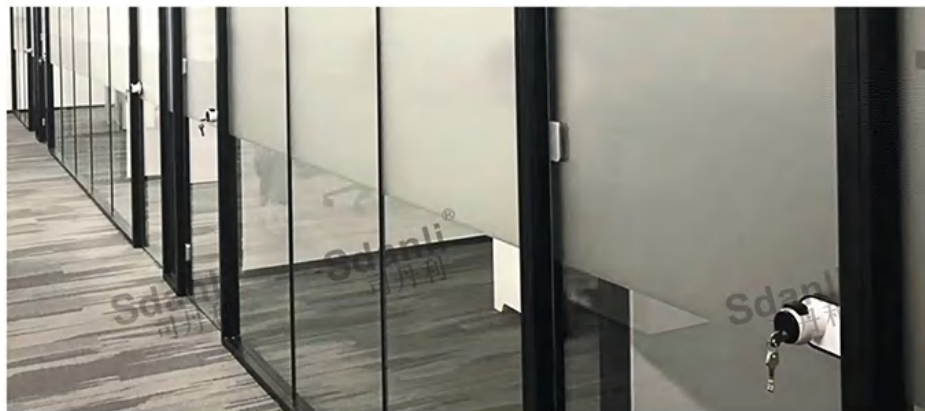

ESH-1097 带盖单边 Covered single-sided

适用于门宽800-1000mm,厚度8-12mm玻璃门安装。
Applicable for 800-1000mm wide and 8-12mm thick

注意: 玻璃必需钢化

承重: 40kg / 对

材质: 锌合金

表面处理: 铬白、拉丝镍、珍珠铬

Note: glass must be toughened

Bearing weight: 40kg / Pair

Material: Zinc alloy

Finish: Chrome, Satin nickel, Pead chrome

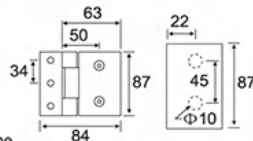

ESH-1098 带盖单边 Covered single-sided

适用于门宽800-1000mm,厚度8-12mm玻璃门安装。
Applicable for 800-1000mm wide and 8-12mm thick

注意: 玻璃必需钢化

承重: 40kg / 对

材质: 锌合金

表面处理: 铬白、拉丝镍、珍珠铬

Note: glass must be toughened

Bearing weight: 40kg / Pair

Material: Zinc alloy

Finish: Chrome, Satin nickel, Pead chrome

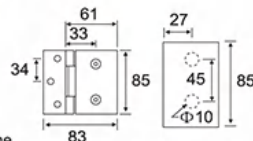

ESH-1099 带盖单边 Covered single-sided

适用于门宽800-1000mm,厚度8-12mm玻璃门安装。
Applicable for 800-1000mm wide and 8-12mm thick

注意: 玻璃必需钢化

承重: 40kg / 对

材质: 锌合金

表面处理: 铬白、拉丝镍、珍珠铬

Note: glass must be toughened

Bearing weight: 40kg / Pair

Material: Zinc alloy

Finish: Chrome, Satin nickel, Pead chrome

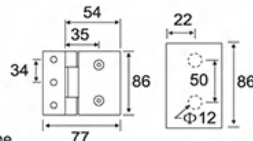

玻璃固定夹系列
Glass Connector Series



规格: 8-10mm钢化玻璃
Size: 8-10mm toughened glass

材质: 黄铜、不锈钢、锌合金
Material: Brass, Stainless steel, Zinc alloy

表面处理: 砂光、镜光
Finish: Satin Nickel, Chrome Plated



ECN-1050D

浴室间断码 0°
Fix clip 0° double hole

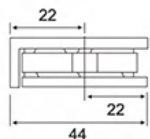

ECN-1050S

浴室间断码 0°
Fix clip 0° single hole

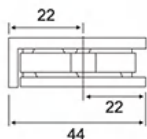

ECN-1052

浴室间断码-90° 双面
Double 90°

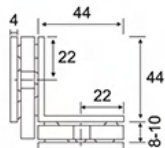

ECN-1051

浴室间断码-90° 单面
Single 90°

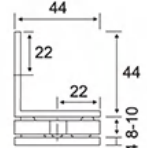

ECN-1054

浴室间断码-135° 双面
Double 135°

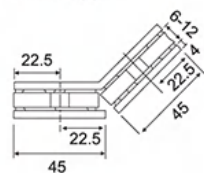

ECN-1053

浴室间断码-135° 单面
Single 135°

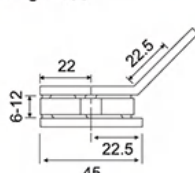

ECN-1056

浴室间断码-180° 双面
Double 180°



ECN-1055

浴室间断码-180° 单面
Single 180°

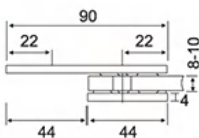

规格: 8-10mm钢化玻璃
Size: 8-10mm toughened glass

材质: 黄铜、不锈钢、锌合金
Material: Brass, Stainless steel, Zinc alloy

表面处理: 砂光、镜光
Finish: Satin Nickel, Chrome Plated



ECN-1056D

浴室间断码 0°
Fix clip 0° double hole

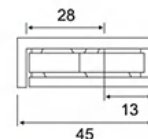

ECN-1056S

浴室间断码 0°
Fix clip 0° single hole

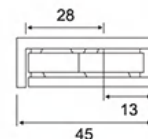

ECN-1057

浴室间断码-90° 双面
Double 90°

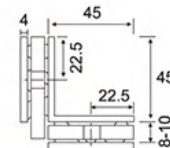

ECN-1058

浴室间断码-90° 单面
Single 90°

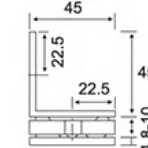

ECN-1059

浴室间断码-135° 双面
Double 135°

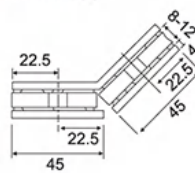

ECN-1060

浴室间断码-135° 单面
Single 135°

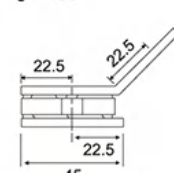

ECN-1061

浴室间断码-180° 双面
Double 180°



ECN-1062

浴室间断码-180° 单面
Single 180°

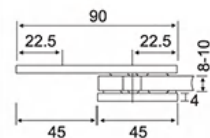

规格: 8-10mm钢化玻璃
Size: 8-10mm toughened glass

材质: 黄铜、不锈钢、锌合金
Material: Brass, Stainless steel, Zinc alloy

表面处理: 砂光、镜光
Finish: Satin Nickel, Chrome Plated

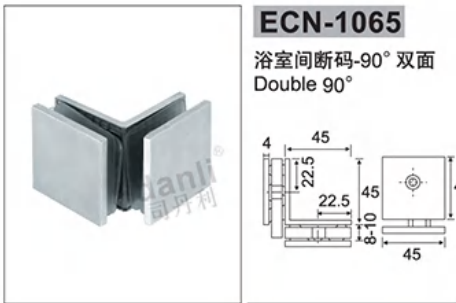

规格: 8-10mm钢化玻璃
Size: 8-10mm toughened glass

材质: 黄铜、不锈钢、锌合金
Material: Brass, Stainless steel, Zinc alloy

表面处理: 砂光、镜光
Finish: Satin Nickel, Chrome Plated

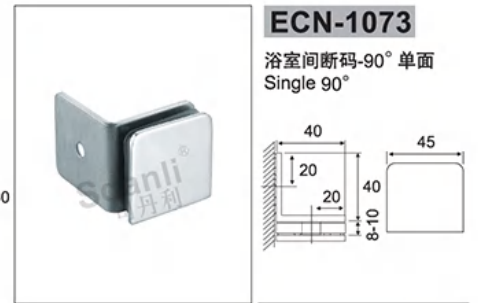

规格: 8-10mm钢化玻璃
Size: 8-10mm toughened glass

材质: 黄铜、不锈钢、锌合金
Material: Brass, Stainless steel, Zinc alloy

表面处理: 砂光、镜光
Finish: Satin Nickel, Chrome Plated



规格: 8-10mm钢化玻璃
Size: 8-10mm toughened glass

材质: 黄铜、不锈钢、锌合金
Material: Brass, Stainless steel, Zinc alloy

表面处理: 砂光、镜光
Finish: Satin Nickel, Chrome Plated



规格: 8-10mm钢化玻璃
Size: 8-10mm toughened glass

材质: 黄铜、不锈钢、锌合金
Material: Brass, Stainless steel, Zinc alloy

表面处理: 砂光、镜光
Finish: Satin Nickel, Chrome Plated



ECN-1094

浴室间断码 0°
Fix clip 0° double hole

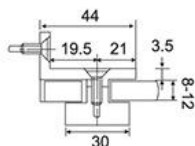

ECN-1095

浴室间断码-90° 单面
Single 90°

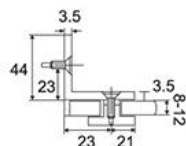

ECN-1096

浴室间断码-90° 双面
Double 90°

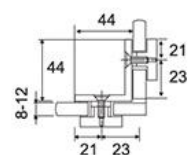

ECN-1097

浴室间断码-135° 单面
Single 135°

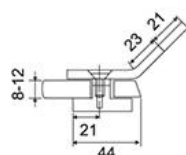

ECN-1098

浴室间断码-135° 双面
Double 135°

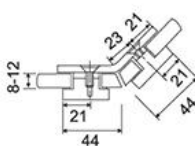

ECN-1099

浴室间断码-180° 单面
Single 180°

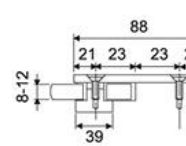

ECN-1100

浴室间断码-180° 双面
Double 180°

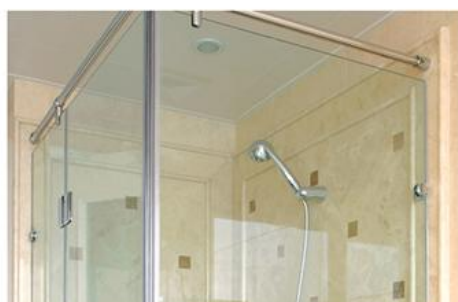
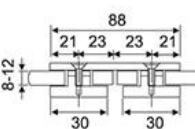

规格: 8-10mm钢化玻璃
Size: 8-10mm toughened glass

材质: 黄铜、不锈钢、锌合金
Material: Brass, Stainless steel, Zinc alloy

表面处理: 砂光、镜光
Finish: Satin Nickel, Chrome Plated



ECN-1085A

浴室间断码 0°
Fix clip 0° single hole

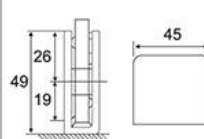

ECN-1085

浴室间断码 0°
Fix clip 0° single hole

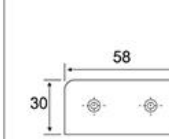

ECN-1153

浴室间断码 0°
Fix clip 0° single hole

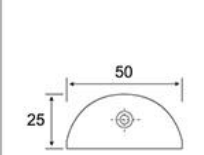

ECN-1103

浴室间断码 0°
Fix clip 0° single hole

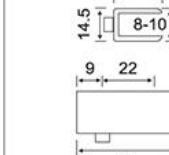

ECN-1154

浴室间断码 0°
Fix clip 0° single hole

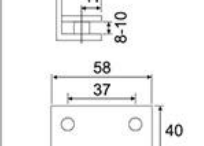

ECN-1155

浴室间断码 0°
Fix clip 0° single hole

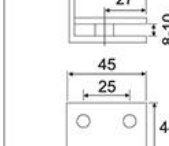

ECN-1156

浴室间断码 0°
Fix clip 0° single hole

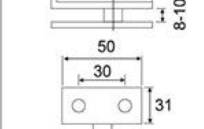

ESH-1035

浴室间断码 0°
Fix clip 0° single hole

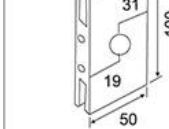



ECN-1157
材质: 不锈钢冲压
Material: Stainless steel
Stamping
表面处理: 拉丝、镜光
Finish: Satin, Polished



60 26 56



ECN-1158
材质: 不锈钢冲压
Material: Stainless steel
Stamping
表面处理: 拉丝、镜光
Finish: Satin, Polished



60 26 56



ECN-1159
材质: 锌合金、不锈钢
Material: Zinc alloy
Stainless steel
表面处理: 拉丝、镜光
Finish: Satin, Polished



57 26 54



ECN-1104
材质: 锌合金、铝
Material: Zinc alloy
Aluminum
表面处理: 拉丝、镜光
Finish: Satin, Polished



57 54



ECN-1105
材质: 不锈钢精铸、锌合金
Material: Stainless steel
Casting, Zinc alloy
表面处理: 拉丝、镜光
Finish: Satin, Polished



63 26 45



ECN-1106
材质: 不锈钢精铸、锌合金
Material: Stainless steel
Casting, Zinc alloy
表面处理: 拉丝、镜光
Finish: Satin, Polished



63 26 45



ECN-1107
材质: 不锈钢精铸、锌合金
Material: Stainless steel
Casting, Zinc alloy
表面处理: 拉丝、镜光
Finish: Satin, Polished



50 26 40



ECN-1108
材质: 不锈钢精铸、锌合金
Material: Stainless steel
Casting, Zinc alloy
表面处理: 拉丝、镜光
Finish: Satin, Polished



45 26 45



ECN-1109
材质: 不锈钢精铸、锌合金
Material: Stainless steel
Casting, Zinc alloy
表面处理: 拉丝、镜光
Finish: Satin, Polished



50 26 40

规格: 8-10mm钢化玻璃
Size: 8-10mm toughened glass

材质: 黄铜、不锈钢
Material: Brass, Stainless steel

表面处理: 氧化
Finish: Oxidation



ECN-1117
0°角槽 (分左右)
0° Edge clamp

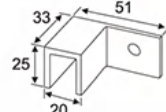

33 51 25 20



ECN-1118
135°角槽
135° Edge clamp

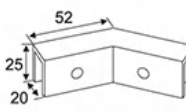

52 25 20



ECN-1119
90°角槽
90° Edge clamp

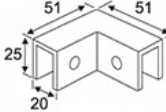

51 51 25 20



ECN-1120
T型角槽
T-Type Edge clamp

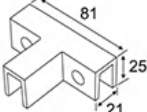

81 25 21



ECN-1121
定位器
Localizer



22 32 19 22 6.2





EBA-1168
180°玻璃夹
180° Glass clamp



87 515 26

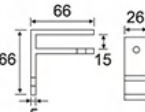

EBA-1169
F型玻璃墙边夹
F Glass wall clamp



66 26 66 15 5



EBA-1170
F型玻璃拐角夹
F Glass Angle clamp



66 26 67 15 515



EBA-1171
玻璃万向夹
Glass Cardan clamp



101 26 101 15 5 15

规格: 8-10mm/10-12mm钢化玻璃
Size: 8-10mm/10-12mm toughened glass

材质: 铝合金
Material: Aluminium alloy

表面处理: 氧化
Finish: Oxidation



ECN-1111

断码
Fix clip

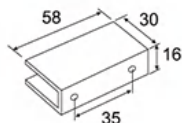

ECN-1112

断码-135° 单面
Double 135°

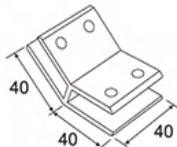

ECN-1113

断码-90° 双面
Double 90°

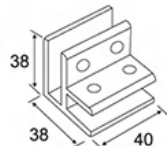

ECN-1114

T型三边
T-Type

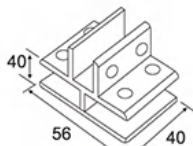

ECN-1115

断码-180° 双面
Double 180°

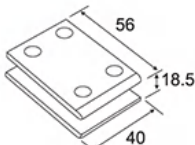

ECN-1116

十型四边
+ -Type

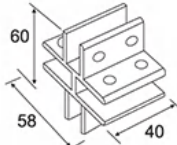

EBA-1190

下档水条
Lower water bar

材质: 铝合金
Material: Aluminium alloy
表面处理: 亮光
Finish: Polished

注意: 可根据客户订做不同规格

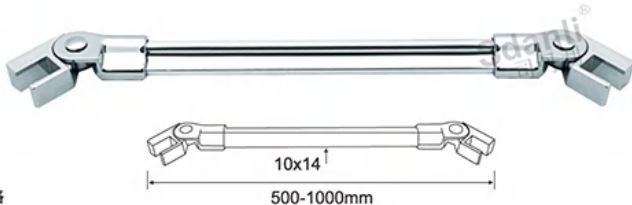

浴室拉杆系列
Bathroom Holder Series

安装示意图
Installation illustration

浴室间隔配件系列选用精纯铜材与304不锈钢制成、构造明确，线型清晰。配合多种安装形式，系列产品齐全，安装方便。

Bathroom connector series select pure copper and 304 Stainless steel, look concisely and clearly. We have complete sets products, and with many kinds of installation, making installation easier.

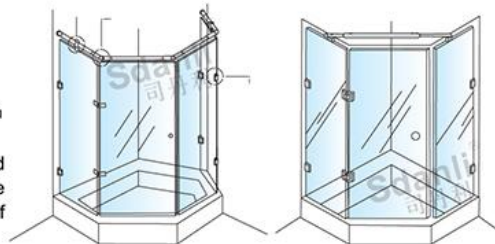

EBA-1110 淋浴房拉杆
Bathroom Rod

材质: 不锈钢
Material: Stainless steel
表面处理: 拉丝、镜光
Finish: Satin, Polished
注意: 可根据客户订做不同规格

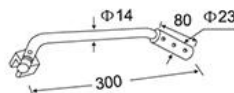

EBA-1111 淋浴房拉杆
Bathroom Rod

材质: 不锈钢
Material: Stainless steel
表面处理: 拉丝、镜光
Finish: Satin, Polished
注意: 可根据客户订做不同规格

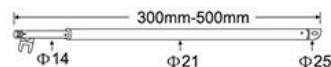

EBA-1112 淋浴房拉杆
Bathroom Rod

材质: 不锈钢
Material: Stainless steel
表面处理: 拉丝、镜光
Finish: Satin, Polished
注意: 可根据客户订做不同规格

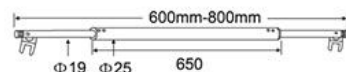

EBA-1113 淋浴房拉杆
Bathroom Rod

材质: 不锈钢
Material: Stainless steel
表面处理: 拉丝、镜光
Finish: Satin, Polished
注意: 可根据客户订做不同规格

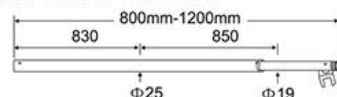

EBA-1115 玻璃固定拉杆
Glass fastness kningthead

材质: 不锈钢
Material: Stainless steel
表面处理: 拉丝、镜光
Finish: Satin, Polished
注意: 可根据客户订做不同规格

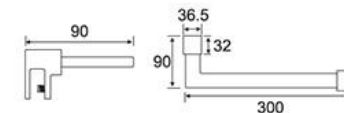

EBA-1116 玻璃固定拉杆
Glass fastness kningthead

材质: 不锈钢
Material: Stainless steel
表面处理: 拉丝、镜光
Finish: Satin, Polished
注意: 可根据客户订做不同规格

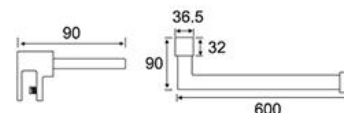

EBA-1117 玻璃固定拉杆
Glass fastness kningthead

材质: 不锈钢
Material: Stainless steel
表面处理: 拉丝、镜光
Finish: Satin, Polished
注意: 可根据客户订做不同规格

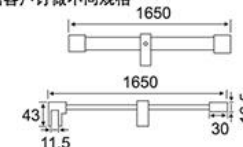

EBA-1118 玻璃固定拉杆
Glass fastness kningthead

材质: 不锈钢
Material: Stainless steel
表面处理: 拉丝、镜光
Finish: Satin, Polished
注意: 可根据客户订做不同规格

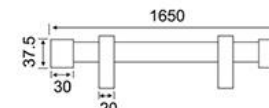

EBA-1119 玻璃固定拉杆
Glass fastness kningthead

材质: 不锈钢
Material: Stainless steel
表面处理: 拉丝、镜光
Finish: Satin, Polished
注意: 可根据客户订做不同规格

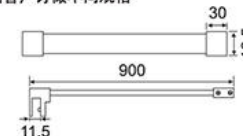



EBA-1120
表面处理: 亮光、拉丝
材质: 锌合金、不锈钢、黄铜
配套圆管: $\Phi 19, \Phi 25$
适用范围: 浴室间隔
Finish: Polished, Satin
Material: Zinc, 304#, 316#, Brass
Diameter: $\Phi 19, \Phi 25$
Available for: bathroom partition

EBA-1123
表面处理: 亮光、拉丝
材质: 锌合金、不锈钢、黄铜
配套圆管: $\Phi 19, \Phi 25$
适用范围: 浴室间隔
Finish: Polished, Satin
Material: Zinc, 304#, 316#, Brass
Diameter: $\Phi 19, \Phi 25$
Available for: bathroom partition

EBA-1124
表面处理: 亮光、拉丝
材质: 锌合金、不锈钢、黄铜
配套圆管: $\Phi 19, \Phi 25$
适用范围: 浴室间隔
Finish: Polished, Satin
Material: Zinc, 304#, 316#, Brass
Diameter: $\Phi 19, \Phi 25$
Available for: bathroom partition

EBA-1127
表面处理: 亮光、拉丝
材质: 锌合金、不锈钢、黄铜
配套圆管: $\Phi 19, \Phi 25$
适用范围: 浴室间隔
Finish: Polished, Satin
Material: Zinc, 304#, 316#, Brass
Diameter: $\Phi 19, \Phi 25$
Available for: bathroom partition

EBA-1122
表面处理: 亮光、拉丝
材质: 不锈钢
配套圆管: $\Phi 19, \Phi 25$
适用范围: 浴室间隔
Finish: Polished, Satin
Material: Stainless steel
Diameter: $\Phi 19, \Phi 25$
Available for: bathroom partition

EBA-1157
表面处理: 亮光、拉丝
材质: 不锈钢
配套圆管: $\Phi 19, \Phi 25$
适用范围: 浴室间隔
Finish: Polished, Satin
Material: Stainless steel
Diameter: $\Phi 19, \Phi 25$
Available for: bathroom partition

EBA-1128
表面处理: 亮光、拉丝
材质: 不锈钢
配套圆管: $\Phi 19, \Phi 25$
适用范围: 浴室间隔
Finish: Polished, Satin
Material: Stainless steel
Diameter: $\Phi 19, \Phi 25$
Available for: bathroom partition

EBA-1132
表面处理: 亮光、拉丝
材质: 不锈钢
配套圆管: $\Phi 19, \Phi 25$
适用范围: 浴室间隔
Finish: Polished, Satin
Material: Stainless steel
Diameter: $\Phi 19, \Phi 25$
Available for: bathroom partition

EBA-1130
表面处理: 亮光、拉丝
材质: 不锈钢
配套圆管: $\Phi 19, \Phi 25$
适用范围: 浴室间隔
Finish: Polished, Satin
Material: Stainless steel
Diameter: $\Phi 19, \Phi 25$
Available for: bathroom partition

EBA-1129
表面处理: 亮光、拉丝
材质: 不锈钢
配套圆管: $\Phi 19, \Phi 25$
适用范围: 浴室间隔
Finish: Polished, Satin
Material: Stainless steel
Diameter: $\Phi 19, \Phi 25$
Available for: bathroom partition

EBA-1133
表面处理: 亮光、拉丝
材质: 不锈钢
配套圆管: $\Phi 19, \Phi 25$
适用范围: 浴室间隔
Finish: Polished, Satin
Material: Stainless steel
Diameter: $\Phi 19, \Phi 25$
Available for: bathroom partition

EBA-1131
表面处理: 亮光、拉丝
材质: 不锈钢
配套圆管: $\Phi 19, \Phi 25$
适用范围: 浴室间隔
Finish: Polished, Satin
Material: Stainless steel
Diameter: $\Phi 19, \Phi 25$
Available for: bathroom partition

EBA-1160

表面处理: 亮光、拉丝
材质: 黄铜、不锈钢
配套方管: 25x25
适用范围: 浴室间隔
Finish: Polished, Satin
Material: Brass, Stainless steel
Square tube: 25x25
Available for: bathroom partition

EBA-1161

表面处理: 亮光、拉丝
材质: 黄铜、不锈钢
配套方管: 25x25
适用范围: 浴室间隔
Finish: Polished, Satin
Material: Brass, Stainless steel
Square tube: 25x25
Available for: bathroom partition

EBA-1162

表面处理: 亮光、拉丝
材质: 黄铜、不锈钢
配套方管: 25x25
适用范围: 浴室间隔
Finish: Polished, Satin
Material: Brass, Stainless steel
Square tube: 25x25
Available for: bathroom partition

EBA-1163

表面处理: 亮光、拉丝
材质: 黄铜、不锈钢
配套方管: 25x25
适用范围: 浴室间隔
Finish: Polished, Satin
Material: Brass, Stainless steel
Square tube: 25x25
Available for: bathroom partition

EBA-1164

表面处理: 亮光、拉丝
材质: 黄铜、不锈钢
配套方管: 25x25
适用范围: 浴室间隔
Finish: Polished, Satin
Material: Brass, Stainless steel
Square tube: 25x25
Available for: bathroom partition

EBA-1165

表面处理: 亮光、拉丝
材质: 黄铜、不锈钢
配套方管: 25x25
适用范围: 浴室间隔
Finish: Polished, Satin
Material: Brass, Stainless steel
Square tube: 25x25
Available for: bathroom partition

EBA-1166

表面处理: 亮光、拉丝
材质: 黄铜、不锈钢
配套方管: 25x25
适用范围: 浴室间隔
Finish: Polished, Satin
Material: Brass, Stainless steel
Square tube: 25x25
Available for: bathroom partition

EBA-1167

表面处理: 亮光、拉丝
材质: 黄铜、不锈钢
配套方管: 25x25
适用范围: 浴室间隔
Finish: Polished, Satin
Material: Brass, Stainless steel
Square tube: 25x25
Available for: bathroom partition

EBA-1134

表面处理: 亮光、拉丝
材质: 铝合金、黄铜、不锈钢
Finish: Polished, Satin
Material: Aluminum, Brass
Stainless steel

EBA-1135

表面处理: 铬、拉丝
材质: 铝合金、黄铜、不锈钢
Finish: Chrome, Satin
Material: Aluminum, Brass
Stainless steel

EBA-1136

表面处理: 铬、拉丝
材质: 铝合金、黄铜、不锈钢
Finish: Chrome, Satin
Material: Aluminum, Brass
Stainless steel

EBA-1137

表面处理: 铬、拉丝
材质: 铝合金、黄铜、不锈钢
Finish: Chrome, Satin
Material: Aluminum, Brass
Stainless steel

EBA-1138

表面处理: 铬、拉丝
材质: 铝合金、黄铜、不锈钢
Finish: Chrome, Satin
Material: Aluminum, Brass
Stainless steel

EBA-1139

表面处理: 铬、拉丝
材质: 铝合金、黄铜、不锈钢
Finish: Chrome, Satin
Material: Aluminum, Brass
Stainless steel

EBA-1140

表面处理: 铬、拉丝
材质: 铝合金、黄铜、不锈钢
Finish: Chrome, Satin
Material: Aluminum, Brass
Stainless steel

EBA-1141

表面处理: 铬、拉丝
材质: 铝合金、黄铜、不锈钢
Finish: Chrome, Satin
Material: Aluminum, Brass
Stainless steel

EBA-1142

表面处理: 铬、拉丝
材质: 铝合金、黄铜、不锈钢
Finish: Chrome, Satin
Material: Aluminum, Brass
Stainless steel

EBA-1143

表面处理: 铬、拉丝
材质: 铝合金、黄铜、不锈钢
Finish: Chrome, Satin
Material: Aluminum, Brass
Stainless steel



EBA-1180

表面处理: 铬、拉丝
材质: 铝合金、黄铜、不锈钢
Finish: Chrome, Satin
Material: Aluminum, Brass
Stainless steel



EBA-1144

表面处理: 铬、拉丝
材质: 铝合金、不锈钢
Finish: Chrome, Satin
Material: Aluminum
Stainless steel

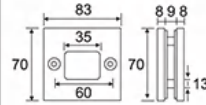

EBA-1145

表面处理: 铬、拉丝
材质: 铝合金、不锈钢
Finish: Chrome, Satin
Material: Aluminum
Stainless steel

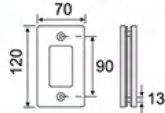

EBA-1146

表面处理: 铬、拉丝
材质: 不锈钢
Finish: Chrome, Satin
Material: Stainless steel

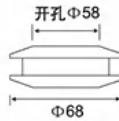

EBA-1147

表面处理: 铬、拉丝
材质: 不锈钢
Finish: Chrome, Satin
Material: Stainless steel

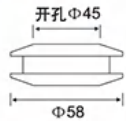

EBA-1148

表面处理: 铬、拉丝
材质: 不锈钢
Finish: Chrome, Satin
Material: Stainless steel

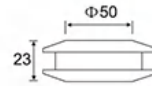

EBA-1181

表面处理: 铬、拉丝
材质: 不锈钢
Finish: Chrome, Satin
Material: Stainless steel



EBA-1149

表面处理: 铬、拉丝
材质: 不锈钢
Finish: Chrome, Satin
Material: Stainless steel

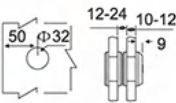

EBA-1182

表面处理: 铬、拉丝
材质: 不锈钢
Finish: Chrome, Satin
Material: Stainless steel



EBA-1183

表面处理: 拉丝、亮光
材质: 黄铜、锌合金
Finish: Satin, Polished
Material: Brass, Zinc alloy

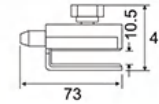

EBA-1184

表面处理: 拉丝、亮光
材质: 黄铜、锌合金
Finish: Satin, Polished
Material: Brass, Zinc alloy

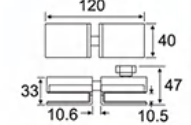

EBA-1150

表面处理: 拉丝、亮光
材质: 黄铜、锌合金
Finish: Satin, Polished
Material: Brass, Zinc alloy

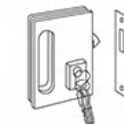

EBA-1151

表面处理: 拉丝、亮光
材质: 黄铜、锌合金
Finish: Satin, Polished
Material: Brass, Zinc alloy

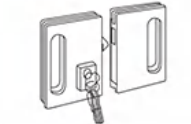

EBA-1185

表面处理: 拉丝、亮光
材质: 不锈钢、黄铜、锌合金
Finish: Satin, Polished
Material: Stainless steel
Brass, Zinc alloy

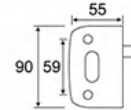

EBA-1186

表面处理: 拉丝、亮光
材质: 不锈钢、黄铜、锌合金
Finish: Satin, Polished
Material: Stainless steel
Brass, Zinc alloy

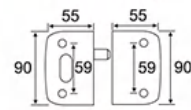

EBA-1187

表面处理: 拉丝、亮光
材质: 不锈钢、黄铜、锌合金
Finish: Satin, Polished
Material: Stainless steel
Brass, Zinc alloy

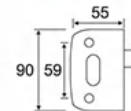

EBA-1188

表面处理: 拉丝、亮光
材质: 不锈钢、黄铜、锌合金
Finish: Satin, Polished
Material: Stainless steel
Brass, Zinc alloy

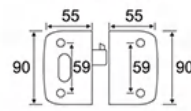

EBA-1189

表面处理: 拉丝、亮光
材质: 不锈钢、黄铜、锌合金
Finish: Satin, Polished
Material: Stainless steel
Brass, Zinc alloy

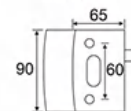



EPV-1403
配装 6/8/10/12mm 玻璃
For:6/8/10/12mm glass

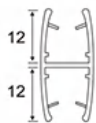

EPV-1401
配装 6/8/10/12mm 玻璃
For:6/8/10/12mm glass

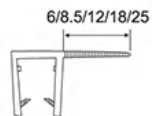

EPV-1400
配装 6/8/10/12mm 玻璃
For:6/8/10/12mm glass

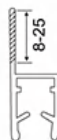

EPV-1416
配装 6/8/10/12mm 玻璃
For:6/8/10/12mm glass



EPV-1424
配装 6/8/10/12mm 玻璃
For:6/8/10/12mm glass

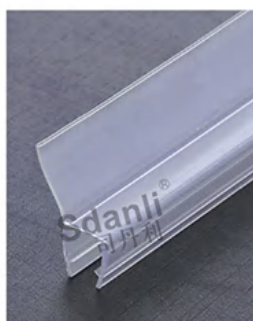
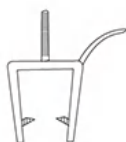

EPV-1425
配装 6/8/10/12mm 玻璃
For:6/8/10/12mm glass

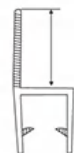

EPV-1406
配装 6/8/10/12mm 玻璃
For:6/8/10/12mm glass

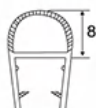

EPV-1426
配装 6/8/10/12mm 玻璃
For:6/8/10/12mm glass



EPV-1421
配装 6/8/10/12mm 玻璃
For:6/8/10/12mm glass

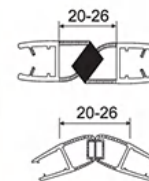

EPV-1420
配装 6/8/10/12mm 玻璃
For:6/8/10/12mm glass

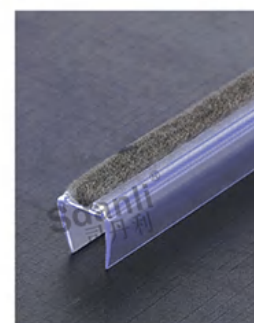
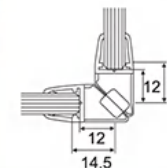

EPV-1427
配装 6/8/10/12mm 玻璃
For:6/8/10/12mm glass



EPV-1428
配装 6/8/10/12mm 玻璃
For:6/8/10/12mm glass

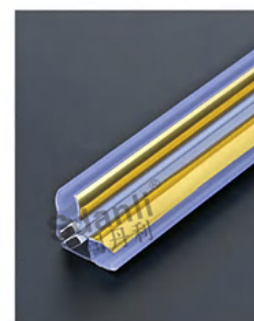

EPV-1429

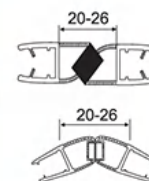

EPV-1430

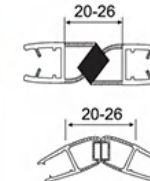

EPV-1431

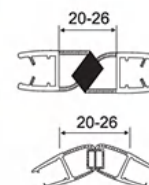

EPV-1432



EBA-5045

卫浴镜 Bathroom Mirror
表面处理: 铬、拉丝
材质: 铝合金、不锈钢
Finish: Chrome, Satin
Material: Aluminum
Stainless steel

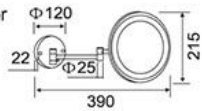

EBA-5046

卫浴镜 Bathroom Mirror
表面处理: 铬、拉丝
材质: 铝合金、不锈钢
Finish: Chrome, Satin
Material: Aluminum
Stainless steel

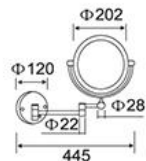

EBA-5047

卫浴镜 Bathroom Mirror
表面处理: 铬、拉丝
材质: 铝合金、不锈钢
Finish: Chrome, Satin
Material: Aluminum
Stainless steel

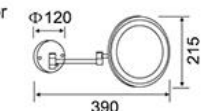

EBA-5048

卫浴镜 Bathroom Mirror
表面处理: 铬、拉丝
材质: 铝合金、不锈钢
Finish: Chrome, Satin
Material: Aluminum
Stainless steel

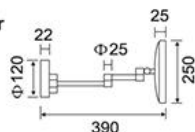

EBA-5049

卫浴镜 Bathroom Mirror
表面处理: 铬、拉丝
材质: 铝合金、不锈钢
Finish: Chrome, Satin
Material: Aluminum
Stainless steel

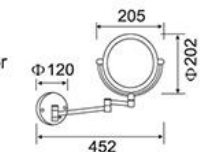

EBA-5050

卫浴镜 Bathroom Mirror
表面处理: 铬、拉丝
材质: 铝合金、不锈钢
Finish: Chrome, Satin
Material: Aluminum
Stainless steel

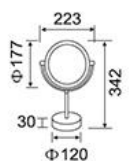

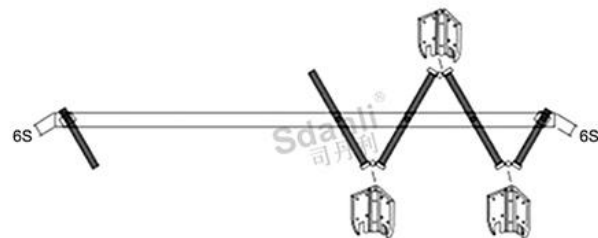
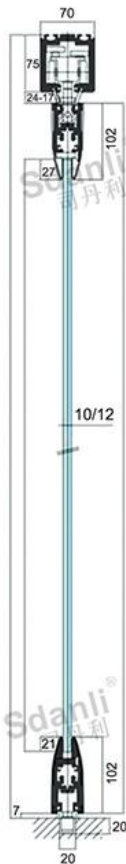
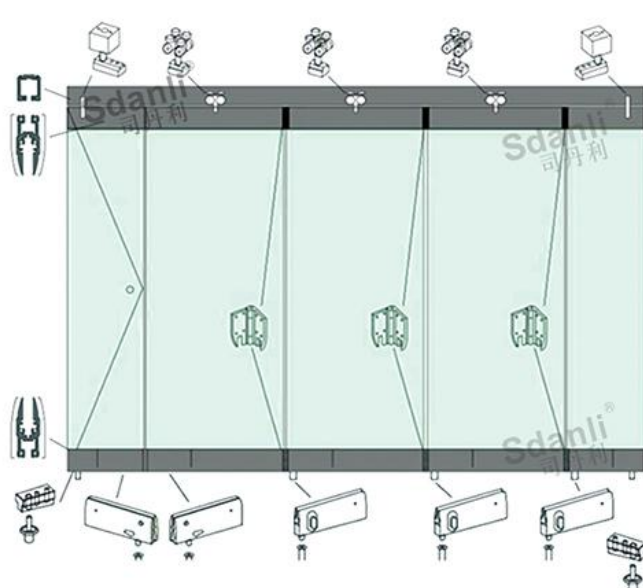

门条之间 40mm
玻璃片之间 55mm
Door strip spacing 40mm
Glass piece spacing 55mm

EWD-100



EWD-100-1



EWD-100-2



EWD-100-3



EWD-100-4



EWD-100-5



EWD-100-6

EWD-200

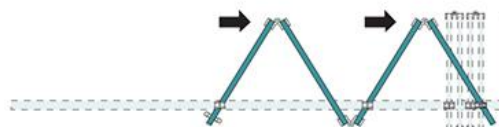
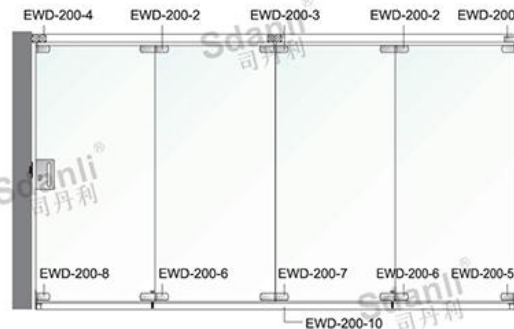

EWD-200-9
上导轨
Upper track



EWD-200-10
下导轨
Lower track



EWD-200-11
玻璃门插销
Glass door bolt



EWD-200-12
玻璃门插销
Glass door bolt



EWD-200-1
上固定门夹
Upper fixing clip



EWD-200-2
玻璃门合页
Glass door hinge



EWD-200-3
折叠门吊轮
Folding door roller



EWD-200-4
折叠门吊轮
Folding door roller



EWD-200-5
下固定门夹
Lower fixing clip



EWD-200-6
玻璃门插销
Glass door bolt



EWD-200-7
下导柱门夹
Lower column clip



EWD-200-8
下导柱门夹
Lower column clip

EWD-300

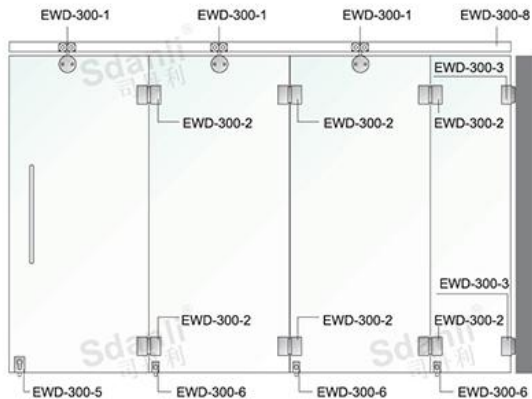

门页最高 Max. door leaf height	2500mm	2500mm	2500mm	2500mm
门页最宽 Max. door leaf width	900mm	900mm	900mm	1/2门页+63
最大承重 Max. door leaf load	70kg	70kg	70kg	—

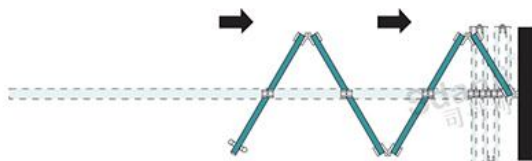

EWD-300-1
折叠门吊轮
Folding door roller



EWD-300-2
玻璃与玻璃合页
Glass to glass hinge



EWD-300-3
玻璃与墙连接合页
Glass to wall hinge



EWD-300-4
玻璃门锁
Glass door lock



EWD-300-5
角锁
Corner lock



EWD-300-6
玻璃门插销
Glass door bolt



EWD-300-7
插销套
Bolt sleeve



EWD-300-8
轨道
Track

ESL-037

标准配置 Standard Application

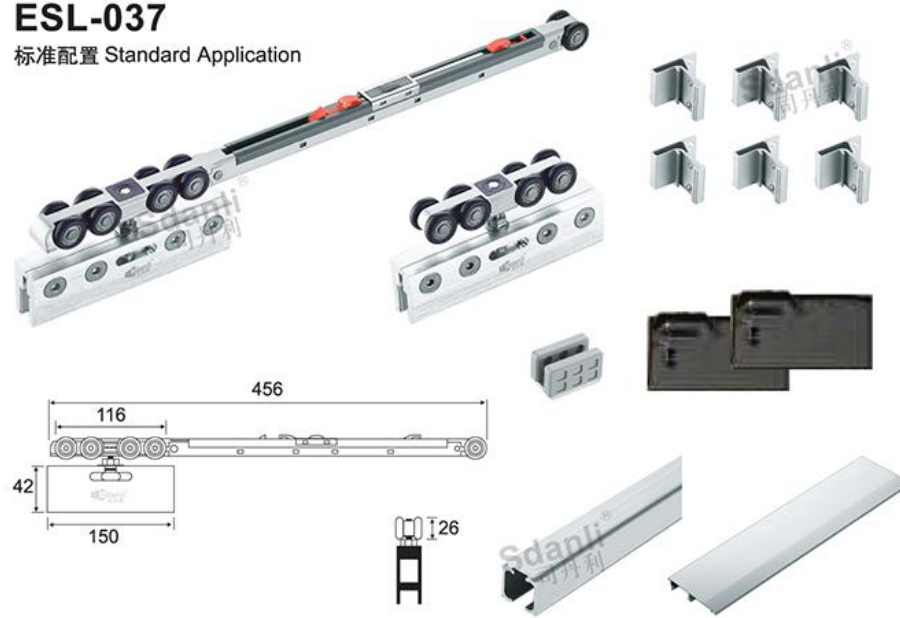



ESL-001 标准配置 Standard Application



ESL-002 标准配置 Standard Application





ESL-003 标准配置 Standard Application



ESL-003-4



EJS-003-4



EJS-003-4



EJS-003-2



EJS-003-4



EJS-003-1



EJS-003-2



EJS-003-2



40x15管



ESL-004 标准配置 Standard Application



ESL-004-4



ESL-004-4



ESL-004-2



ESL-004-2



ESL-004-2



ESL-004-1



ESL-004-1



40x15管



ESL-005 标准配置 Standard Application



ESL-005-4



ESL-005-4



ESL-005-4



ESL-005-2



ESL-005-1



ESL-005-2



ESL-005-2



40x15管



ESL-006 标准配置 Standard Application



ESL-006-2



ESL-006-2



ESL-006-2



ESL-006-2



ESL-006-2



ESL-006-1



30x10管

ESL-007 标准配置 Standard Application



ESL-008 标准配置 Standard Application



ESL-009 标准配置 Standard Application



ESL-010 标准配置 Standard Application





ESL-032 标准配置 Standard Application



ESL-032-4



ESL-032-4



ESL-032-2



ESL-032-1



ESL-032-1



ESL-032-1



ESL-032-1



ESL-032-2



ESL-034 标准配置 Standard Application



ESL-034-4



ESL-034-2



ESL-034-2



ESL-034-2



ESL-034-1



ESL-034-1



Φ25管



ESL-033 标准配置 Standard Application



ESL-033-2



ESL-033-2



ESL-033-2



ESL-033-1



ESL-033-1



ESL-033-1



ESL-033-1



ESL-035 标准配置 Standard Application



ESL-035-2



ESL-035-2



ESL-035-2



ESL-035-2



ESL-035-2



ESL-035-1



ESL-035-1



30x15椭圆管



ESL-036 标准配置 Standard Application



ESL-039 标准配置 Standard Application



ESL-038 标准配置 Standard Application



ESL-040 标准配置 Standard Application



ESL-011(A款) 标准配置 Standard Application



ESL-011-1-2



ESL-011-2-1



ESL-011-3-4



ESL-011-4-2

ESL-011(B款) 标准配置 Standard Application



ESL-011-1-2



ESL-011-2-1



ESL-011-3-4



ESL-011-4-2

ESL-012(A款) 标准配置 Standard Application



ESL-012-1-2



ESL-012-2-1



ESL-012-3-4



ESL-012-4-2

ESL-012(B款) 标准配置 Standard Application



ESL-012-1-2



ESL-012-2-1



ESL-012-3-4



ESL-012-4-2

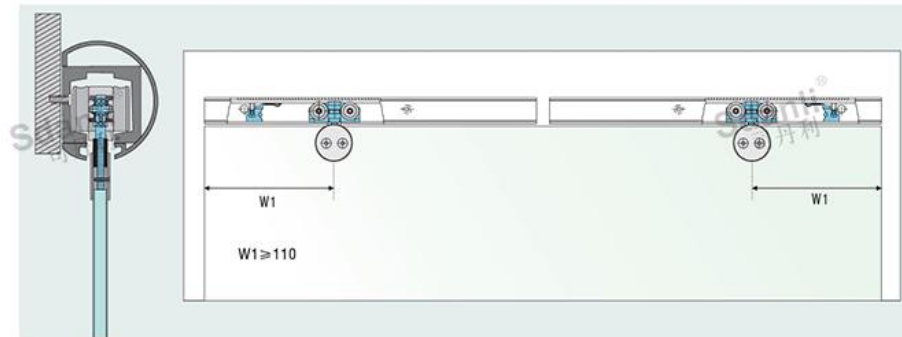

ESL-013 标准配置 Standard Application

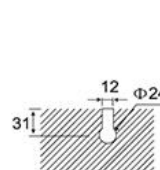

ESL-013-1-2
(Zinc alloy)



ESL-013-1-2



ESL-013-2-2



ESL-013-3-1



ESL-013-4-1



ESL-013-5-1



ESL-013-6-1

ESL-014 标准配置 Standard Application

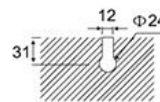

ESL-014-1-2
(Zinc alloy)



ESL-014-1-2



ESL-014-2-1



ESL-014-3-1



ESL-014-4-1



ESL-014-5-1



ESL-014-6-1

ESL-015 标准配置 Standard Application



ESL-015-1-2
(Zinc alloy)



ESL-015-1-2



ESL-015-2-2



ESL-015-4-1



ESL-015-5-1



ESL-015-6-1



ESL-015-3-1



ESL-022

T型固定件
T-type fittings

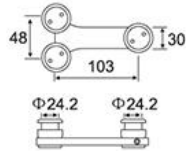

ESL-023

直型固定件
Fixed fittings

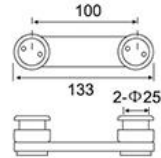

ESL-024

管夹
Clamp fixing for track
(与玻璃连接)
The connection with glass

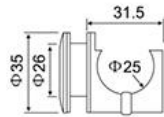

ESL-025

管夹
Clamp fixing for track
(与墙体连接)
The connection with wall

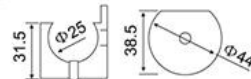

ESL-026

定位器
Localizer

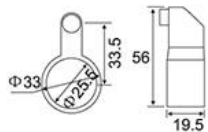

ESL-027

管夹
Clamp fixing for track
(与玻璃连接)
The connection with glass

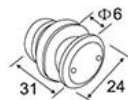

ESL-028

管夹
Clamp fixing for track
(与玻璃连接)
The connection with glass

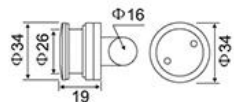

ESL-029

管夹
Clamp fixing for track
(与墙体连接)
The connection with wall

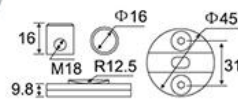

ESD-016

玻璃吊轮

Glass hanging wheel
表面处理: 铬白、拉丝镍
主要材质: 不锈钢、铁
规格: 10-18mm钢化玻璃
最大承重: 100kg
Finish: Chrome, Nickel
Material: Stainless steel, Iron
Size: 10-18mm toughened glass
Max door weight: 100kg

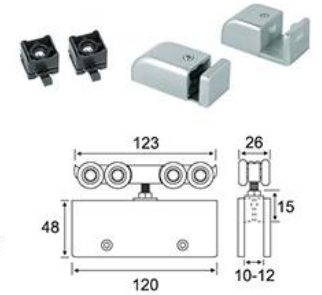

ESD-017

玻璃吊轮

Glass hanging wheel
表面处理: 铬白、拉丝镍
主要材质: 不锈钢、铁
规格: 10-18mm钢化玻璃
最大承重: 100kg
Finish: Chrome, Nickel
Material: Stainless steel, Iron
Size: 10-18mm toughened glass
Max door weight: 100kg

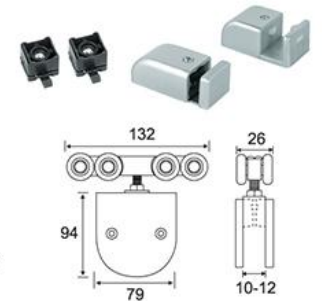

ESD-030

木门吊轮

Wood door hanging wheel
表面处理: 镜光、拉丝
主要材质: 不锈钢、铁
最大承重: 100kg
Finish: Mirror, Drawbench
Material: Stainless steel, Iron
Max door weight: 100kg



ESD-031

木门吊轮

Wood door hanging wheel
表面处理: 镜光、拉丝
主要材质: 不锈钢、铁
最大承重: 100kg
Finish: Mirror, Drawbench
Material: Stainless steel, Iron
Max door weight: 100kg

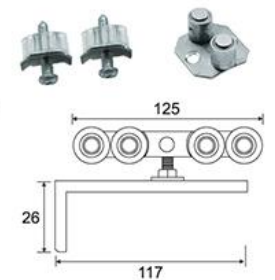

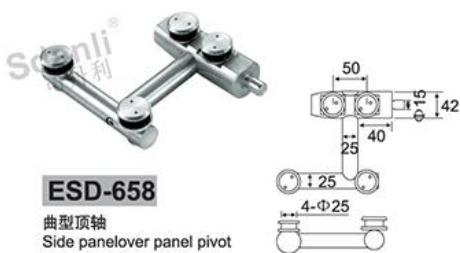

ESD-658

曲型顶轴
Side panelover panel pivot
材质: 不锈钢
Material:Stainless steel

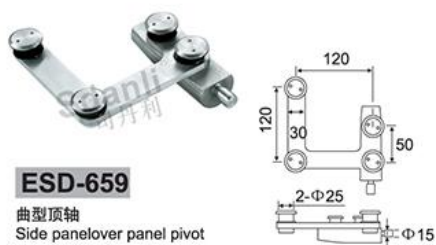

ESD-659

曲型顶轴
Side panelover panel pivot
材质: 不锈钢
Material:Stainless steel

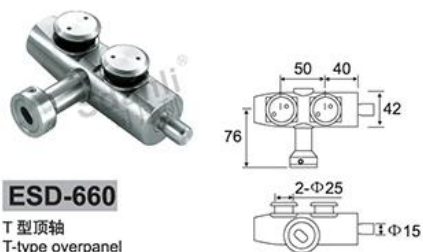

ESD-660

T型顶轴
T-type overpanel
材质: 不锈钢
Material:Stainless steel



ESD-661

曲型固定件
Side panelover panel connector
材质: 不锈钢
Material:Stainless steel

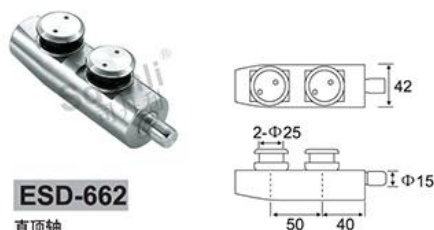

ESD-662

直顶轴
Over panel pivot
材质: 不锈钢
Material:Stainless steel

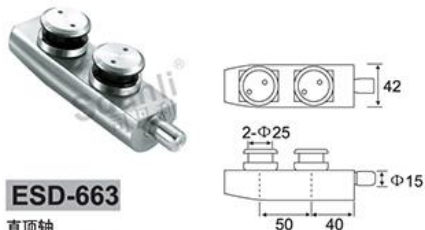

ESD-663

直顶轴
Over panel pivot
材质: 不锈钢
Material:Stainless steel



ESD-666

曲型顶轴
Side panelover panel pivot
材质: 不锈钢
Material:Stainless steel



ESD-667

直顶轴
Over panel pivot
材质: 不锈钢
Material:Stainless steel

ESD-668

上轴
Top door pivot
材质: 不锈钢
Material:Stainless steel



ESD-669

地轴
Bottom door pivot
材质: 不锈钢
Material:Stainless steel



ESD-684 上轴 Top pivot

材质: 精铸不锈钢
Material:Casting stainless steel

外观尺寸 Dimensions

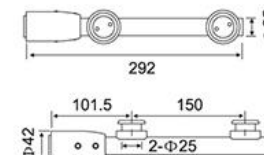

ESD-685 下轴 Bottom pivot

可提供各类型地弹簧接头
材质: 精铸不锈钢
Material:Casting stainless steel

外观尺寸 Dimensions

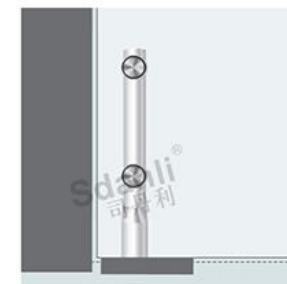
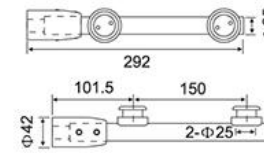

ESD-642

单杆固定件
Class/wall Corner connector
(墙体与玻璃连接, 单头可调角度)
Connection for connecting wall and glass, just one sides can adjusted angle

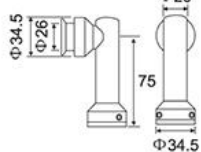

ESD-643

单杆固定件
Class/wall Corner connector
(墙体与玻璃连接, 单头不可调角度)
Connection for connecting wall and glass, just one sides can't be adjustable

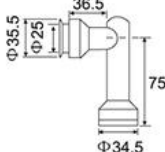

ESD-644

单杆固定件
Class/wall Corner connector
(墙体与玻璃连接, 双头可调角度)
Connecting wall and glass, both sides can adjusted angle

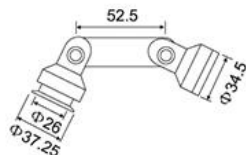

ESD-645

单杆固定件
Class/wall Corner connector
(墙体与玻璃连接, 双头不可调角度)
Connecting wall and glass, both sides can adjusted angle

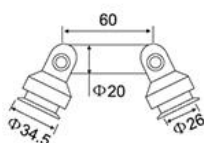

ESD-646

双杆固定件
Class/wall Corner connector
(墙体与玻璃连接, 四头可调角度)
Connecting glass and glass, four directions sides can adjusted angle

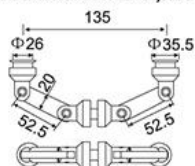

ESD-647

单杆固定件
Class/wall Corner connector
(墙体与玻璃连接, 双头可调角度)
Connecting wall and glass, both sides can adjusted angle

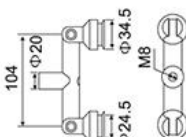

ESD-648

单杆固定件
Class/wall Corner connector
(墙体与玻璃连接, 不可调角度)
Connection wall and glass, can't be adjustable

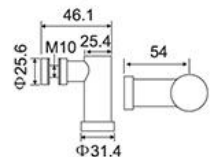

Use: two kinds options of glass connection mainly used for clamping glass.
Two kinds connecting for glass holes:

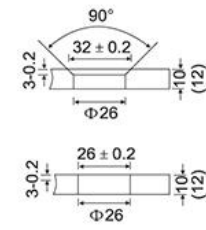

玻璃的安装和处理
玻璃/玻璃边角对接装置, 用于厚度为10毫米与12毫米的钢化玻璃

GLASS PREPARATION
For glass/glass corner connectors for



平面图(俯视图)
Planview

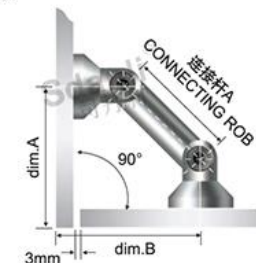

结构部件与组装示意图
Components and assembly of the wall fixing

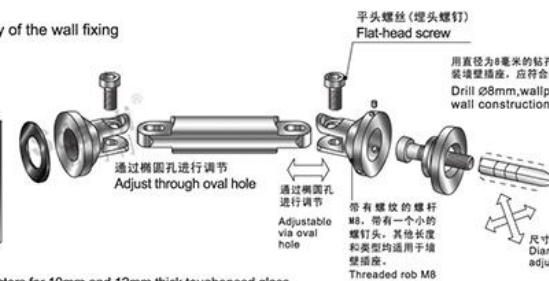

用直径为8毫米的钻孔, 以便在墙壁上安装墙壁插座, 应符合建筑结构的要求。
Drill Ø8mm, wallplug on site to suit wall construction

尺寸调节
Dimensional adjustment

For glass/glass corner connectors for 10mm and 12mm thick toughened glass.

ESD-657

连接杆
Connecting rod

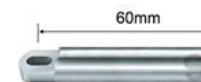

ESD-649

ESD-650

ESD-651

ESD-652

ESD-653



ESD-654 单杆固定杆/连接墙体
Wall to glass connector STD(cable connection)

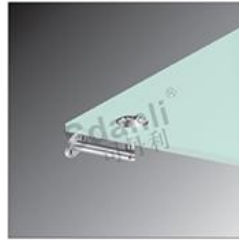
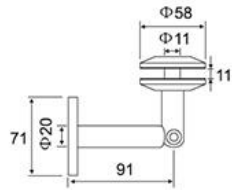

ESD-655 悬臂支架/连接墙体
Rear cantilever wall bracket STD(cable connection)
(与玻璃连接)
The connection with glass

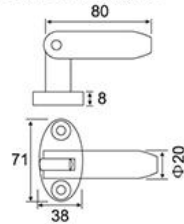

ESD-656 吊索固定杆/与玻璃连接
Front cantilever glass bracket STD(cable connection)
(再大玻璃承重100kg)
The maximum weight is 100kg

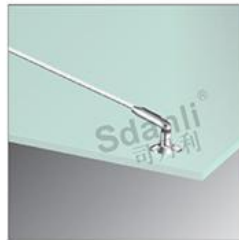
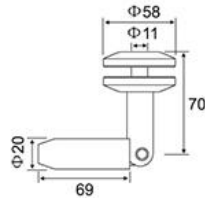

EHF-670

EHF-671

Advertising screws series
Material:Stainless steel.Cuprum
Finish: Satin / Stainless steel



EHF-672

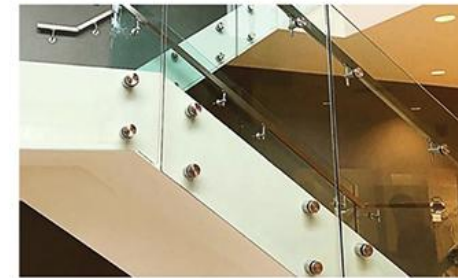

EHF-673

Material: CF8/CF8M
Surface finish: satin/mirror
Glass thickness T:12~20mm

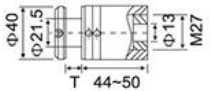

EHF-674

Material: CF8/CF8M
Surface finish: satin/mirror
Glass thickness T:12~20mm

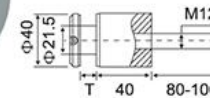

EHF-676

Material: CF8/CF8M
Surface finish: satin/mirror
Glass thickness T:8~16mm

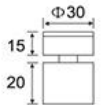

EHF-675

Material: CF8/CF8M
Surface finish: satin/mirror
Glass thickness T:12~20mm

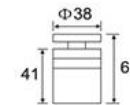

EHF-677

Material: CF8/CF8M
Surface finish: satin/mirror
Glass thickness T:8~16mm

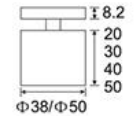

表面处理: 砂光、镜光
Finish: Satin Nickel, Chrome Plated

材质: 精铸不锈钢
Material: Casting Stainless steel

主要功能: 玻璃固定连接
Function: Glass fixed connect

适用范围: 幕墙玻璃
Available for: Curtain wall glass

表面处理: 砂光、镜光
Finish: Satin Nickel, Chrome Plated

材质: 精铸不锈钢
Material: Casting Stainless steel

主要功能: 玻璃固定连接
Function: Glass fixed connect

适用范围: 幕墙玻璃
Available for: Curtain wall glass



EHF-678

四爪
4-Claw glass spider

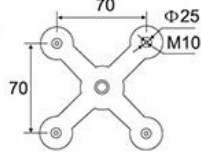

EHF-689

三爪
3-Claw glass spider

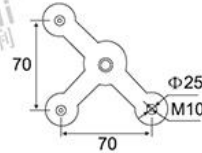

EHF-680

180° 双爪
180° 2-Claw spider

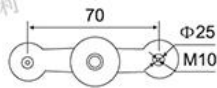

EHF-681

90° 双爪
90° 2-Claw spider

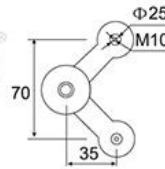

EHF-682

小单爪
180° Single spider

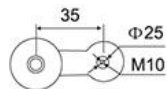

EHF-683

小90° 单爪
90° Single spider

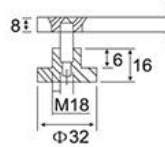

EJ-ASS1

驳接头 Routil

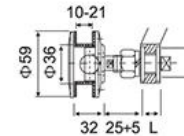

EJ-ASS2

驳接头 Routil

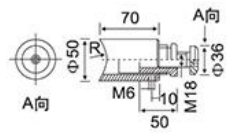

EJ-141S

长单爪
1-Claw glass spider (long)

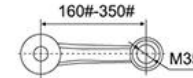

EJ-141L

短单爪
1-Claw glass spider (short)

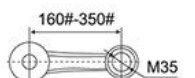

EJ-142

180° 双爪
180° 2-Claw glass spider

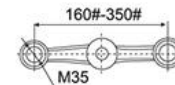

EJ-143

90° 双爪
90° 2-Claw glass spider

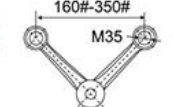

EJ-144

三爪
3-Claw glass spider

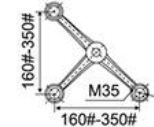

EJ-145

四爪
4-Claw glass spider

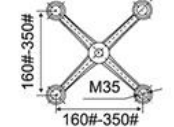

EJ-146

K型爪
K-Claw glass spider

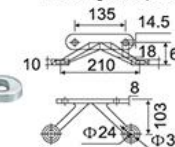

EJ-147

T型爪
T-Claw glass spider

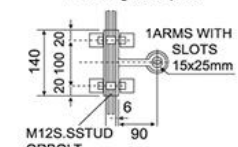

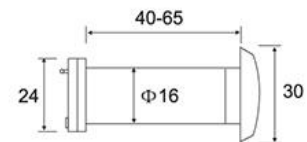

EWD-3035 200° 猫眼 200° Door viewer

材质: 黄铜、锌合金
Material: Brass, Zinc alloy
表面处理: 亮光, 黑色, 红古铜, 青古铜, 钛金
Finish: Polished, Black, Red Bronze, Green Bronze, Titanium Gold
适用门厚: 40-65mm, 带后盖
Available door thickness: 40-65mm

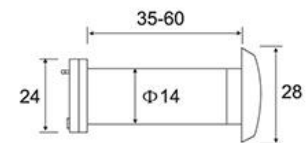

EWD-3037 200° 猫眼 200° Door viewer

材质: 黄铜、锌合金
Material: Brass, Zinc alloy
表面处理: 亮光, 黑色, 红古铜, 青古铜, 钛金
Finish: Polished, Black, Red Bronze, Green Bronze, Titanium Gold
适用门厚: 35-60mm, 带后盖
Available door thickness: 35-60mm

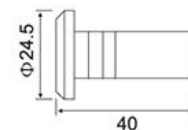

EWD-3038 插销防尘套 Dust cover

材质: 不锈钢
Material: Stainless steel
表面处理: 拉丝
Finish: Satin

EFF-3218

门顶 Door stopper

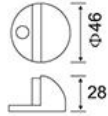

EFF-3219

门顶 Door stopper

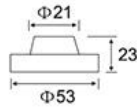

EFF-3220

门顶 Door stopper

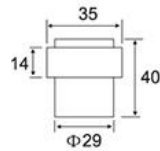

EFF-3221

门顶 Door stopper

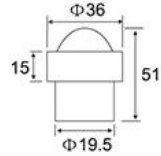

EFF-3222

门顶 Door stopper

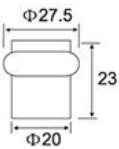

EFF-3223

门顶 Door stopper

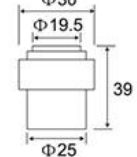

EFF-3224

门顶 Door stopper



EFF-3225

门顶 Door stopper

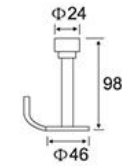

EFF-3226

门顶 Door stopper

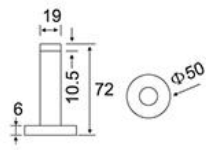

EFF-3227

门顶 Door stopper

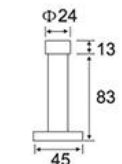

EFF-3044 家具小拉手 Furniture handle

材质: 不锈钢/铁
Material: Stainless steel/Iron
表面处理: 拉丝
Finish: Satin

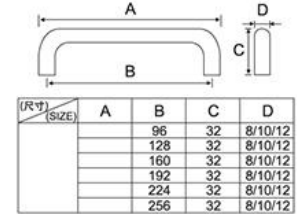

EFF-3045 家具小拉手 Furniture handle

材质: 不锈钢/铁
Material: Stainless steel/Iron
表面处理: 拉丝
Finish: Satin

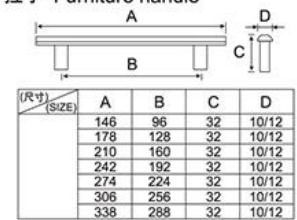

EFF-3046 家具小拉手 Furniture handle

材质: 不锈钢/铁
Material: Stainless steel/Iron
表面处理: 拉丝
Finish: Satin

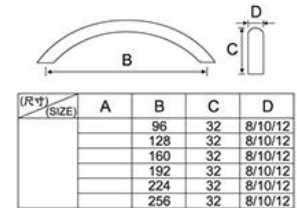

EFF-3047 家具小拉手 Furniture handle

材质: 不锈钢/铁
Material: Stainless steel/Iron
表面处理: 拉丝
Finish: Satin

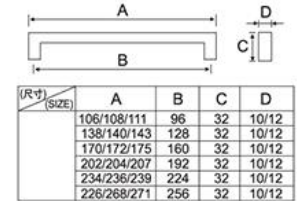

EFF-3048 家具小拉手 Furniture handle

材质: 不锈钢/铁
Material: Stainless steel/Iron
表面处理: 拉丝
Finish: Satin

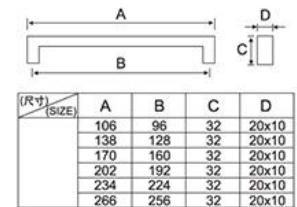



EJ-3039 金属门手动暗插销 Bolt

材质: 304不锈钢
Material: 304 Stainless steel
表面处理: 拉丝
Finish: Satin
尺寸: 6"/8"/12"/24" 尺寸可选

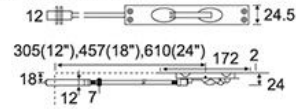

EJ-3040 木质暗插销 Bolt

材质: 304不锈钢
Material: 304 Stainless steel
表面处理: 拉丝
Finish: Satin
尺寸: 6"/8"/10"/12" 尺寸可选

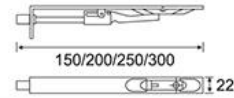

EJ-3041 木质盒式冲压手动暗插销 Bolt

材质: 304不锈钢
Material: 304 Stainless steel
表面处理: 拉丝
Finish: Satin
尺寸: 6"/8"/10"/12"/18"/24"/40" 尺寸可选

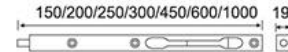

EJ-3042 防盗扣 Anti-theft clasp

材质: 锌合金
Material: Zinc alloy
表面处理: 镀铬亮光
Finish: CP

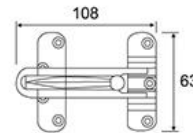

EJ-3043 防盗链 Anti-theft clasp

材质: 锌合金
Material: Zinc alloy
表面处理: 镀铬亮光
Finish: CP

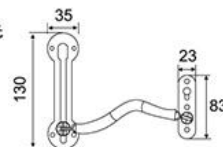

Notebook

